



Sanitärwand

Konformität zu Schweizer Normen (SVGW) und Schweizer Bedürfnissen
Beinhaltet Originalersatzteile (KWC, Similor und Geberit)

Cloison Sanitaire

Conforme aux normes suisse (approbation SSIG) et aux besoins suisse
Avec des pièces de rechange d'origine (KWC, Similor et Geberit)

Inhaltsverzeichnis / Table des matières

Ersatzteile KWC	Pièce de rechange KWC	1.3
Ersatzteile SIMILOR	Pièce de rechange SIMLOR	1.5
Oberteile und Griffe	Têtes de robinet et poignées	1.8
Anschlussverschraubungen	Raccords	1.10
Rosetten	Rosaces	1.11
Eck-Regulierventile	Robinets de réglage d'angle	1.13
Doppelventile / Geschirrmaschinenventile	Robinets d'arrêt double / Robinets lave-vaisselle	1.16
Geräteanschlussventile	Raccordements de machines	1.17
Durchgangsventile	Vanne de passage	1.18
Kugelhähne	Robinets à boisseau sphérique	1.18
Ablaufventile	Soupapes d'écoulement	1.20
Ventilstopfen	Bouchons pour soupape	1.22
Ventilstopfen Snap	Bouchon pour soupape Snap	1.22
Ventilstopfen Funny	Bouchon pour soupape Funny	1.24
Badewannenstopfen	Bouchons pour baignoires	1.25
Hahnlochstopfen	Bouchon pour trou robinet	1.25
Waschtisch-Siphons	Siphons de lavabo	1.26
Raumsparsiphons	Siphons compact	1.26
Waschtisch-Siphons GEBERIT	Siphons de lavabo GEBERIT	1.28
Waschtisch-Siphons Messing verchromt	Siphons de lavabo en laiton chromé	1.29
Küchensiphons	Siphons pour évier	1.31
Spültischgarnituren GEBERIT	Siphons pour évier GEBERIT	1.31
Siphons für Duschtasse	Siphons de douche	1.32
Siphons für Duschtasse GEBERIT	Siphons de douche GEBERIT	1.32
Wannengarnituren GEBERIT	Garniture de baignoire GEBERIT	1.33
Rohrbogensiphons GEBERIT	Siphons en tube coudé GEBERIT	1.34
Manchetten und Anschlüsse für WC GEBERIT	Manchons et raccordements pour WC GEBERIT	1.35
Abflussanschlüsse und Reduktionen	Raccords d'écoulement et réductions	1.36
Ablaufschläuche Vario	Tuyaux de vidange Vario	1.37

Inhaltsverzeichnis / Table des matières

Gartenventile	Robinets de jardin	1.39
Ablaufventil	Robinet de fuite	1.40
Schlauchverschraubungen	Raccords de flexible	1.41
Bewässerungssystem NEOMATIC	Système d'arrosage NEOMATIC	1.42
Wasch-/Spülmaschinen Set NEOMATIC	Set pour machine à laver NEOMATIC	1.46
Spritzdüsen NEOMATIC	Lances NEOMATIC	1.46
Übergangsstück NEOMATIC	Pièce de jonction NEOMATIC	1.46
Briden	Colliers	1.47
Y-Abzweigstücke	Raccords Y	1.47
Zubehör für Bewässerung NEOMATIC	Accessoires pour arrosage NEOMATIC	1.48
Gartendusche	Douche à jardin	1.50
Fittinge Messing	Pièces de raccord en laiton	1.51
Fittinge Rotguss	Pièces de raccord bronze	1.54
Fittinge verzinkt	Pièces de raccord galvanisées	1.56
Rohrschellen	Colliers de serrage	1.63
Rohrbänder	Brides	1.65
Klemmverschraubungen	Raccords de serrage	1.66
Kupferrohre gerade	Tubes droit en barre	1.69
Rohrclips	Clips pour tube	1.70
PEX Trinkwasser-Verteilung	PEX distribution d'eau	1.71
Raccord-Dichtungen	Joints pour raccord	1.76
Fiberdichtungen	Joints en fibre	1.77
Gummidichtungen	Joints en caoutchouc	1.78
Oberteildichtungen	Joints bonnet	1.79
O-Ringe	Joints torique	1.80
Dichtungssortimente	Assortiments de joints	1.81
Keildichtungen	Joints conique en plastique	1.82
Hutfilter mit Dichtung	Filtres de rechange avec joint	1.82
Siphonverbinder	Connecteurs de siphon	1.82
Dichtungssets & Dichtungen für Siphon Waschtisch & Spüle	Sets joint et joints pour siphon lavabo et evier	1.83
WC Spülrohrverbinder	Manchettes WC pour tube de chasse	1.84
Heberglockendichtung	Joint de cloche chasse d'eau	1.85
Dichtungen zu AP Spülkasten	Joints pour chasse d'eau posé	1.85
Montagematerial	Matériel de montage	1.86
Reinigung und Service	Nettoyage et maintenance	1.89
Universal-Füllventil Geberit	Robinet-flotteur universel	1.92
Heizkörperthermostate	Thermostat radiateurs	1.93
Panzerschläuche FLEXO®	Tuyeaux renforcés FLEXO®	1.96
Panzerschläuche TECHLINE NT (nicht Trinkwasser)	Tuyeaux renforcés TECHLINE NT (d'eau non potable)	1.103
Prospekte und Verkaufshilfen	Prospectus et aides de vente	1.104

KWC Ersatzteile

KWC pièces de rechange

	EAN-Nr. <i>no EAN</i>	Artikel Nr. <i>no d'article</i>	Beschreibung <i>description</i>	VPE <i>ce</i>	VE <i>ue</i>	UVP pro Stk. PVC CHF excl.	UVP pro Stk. PVC CHF incl.
--	--------------------------	------------------------------------	------------------------------------	------------------	-----------------	-------------------------------------	-------------------------------------

Flachtelleroberteil

Tête de robinet à clapet plat



7 611038 118082	07 0453 97	M20 x 1,25 ; K.32.40.01.931	5		23.21	25.—
7 611038 690373	07 0453 98	M20 x 1.25	3		34.35	37.—



NEW

Griff Star 2.0 komplett blau

Poignée KWC STAR compl. bleu



7 612158 537944	07 0440 96	Metall, chromeline <i>métal, chromeline</i> Z.538.695.000	48		26.93	29.—
7 611038 236830	07 0440 98	Metall, chromeline <i>métal, chromeline</i> Z.538.695.000	3		34.35	37.—



Rückwärtskompatibel mit
Kunststoffgriffen KWC.
Nachfolgemodell 2022 zu
07 0450 96 / Z.501.928.033
*Rétrocompatible avec poignées
KWC en matière synthétique.*
Modèle suivant 2022 pour
07 0450 96 / Z.501.928.033

NEW

Griff Star 2.0 komplett rot

Poignée KWC STAR compl. rouge



7 612158 537951	07 0441 96	Metall, chromeline <i>métal, chromeline</i> Z.538.696.000	48		26.93	29.—
7 611038 236847	07 0441 98	Metall, chromeline <i>métal, chromeline</i> Z.538.696.000	3		34.35	37.—



Rückwärtskompatibel mit
Kunststoffgriffen KWC.
Nachfolgemodell 2022 zu
07 0451 96 / Z.501.929.033
*Rétrocompatible avec poignées
KWC en matière synthétique.*
Modèle suivant 2022 pour
07 0451 96 / Z.501.929.033



KWC Ersatzteile

KWC pièces de rechange

	EAN-Nr. <i>no EAN</i>	Artikel Nr. <i>no d'article</i>	Beschreibung <i>description</i>	VPE <i>ce</i>	VE <i>ue</i>	UVP pro Stk. PVC CHF excl.	UVP pro Stk. PVC CHF incl.
--	--------------------------	------------------------------------	------------------------------------	------------------	-----------------	-------------------------------------	-------------------------------------

Hebelset zu KWC DOMO

Jeu de levier pour KWC DOMO

	 7 611038 690410	07 0468 98	chromeline <i>chromeline</i>	10		67.78	73.—
--	------------------------------------------------------------------------------------------------------	------------	---------------------------------	----	-------------------------------------------------------------------------------------	-------	------



KWC
Swiss Water Experience

SIMILOR Ersatzteile

SIMILOR pièces de rechange

	EAN-Nr. <i>no EAN</i>	Artikel Nr. <i>no d'article</i>	Beschreibung <i>description</i>	VPE <i>ce</i>	VE <i>ue</i>	UVP pro Stk. PVC CHF excl.	UVP pro Stk. PVC CHF incl.
--	--------------------------	------------------------------------	------------------------------------	------------------	-----------------	-------------------------------------	-------------------------------------

Sanitär Norm-Oberteil

Tête de robinet norme sanit.



7 612742 174883	07 0650 97	zu SK Silor pour SK Silor M20 x 1.25 ; 1.07330.000.000	1		21.82	23.50
7 611038 690427	07 0650 98	zu SK Silor pour SK Silor M20 x 1.25	5		27.86	30.—



Griff steckbar

Poignée enfichable eau froid



7 611038 118099	07 0651 96	blau Kaltwasser / chrom chromé - bleu 1.08800.100.820	5		29.25	31.50
7 611038 690434	07 0651 98	chrom - blau chromé - bleu 1.08800.100.820	3		31.10	33.50



Griff steckbar

Poignée enfichable eau froid



7 611038 118105	07 0652 96	rot Kaltwasser / chrom chromé - rouge 1.08800.100.825	5		29.25	31.50
7 611038 690441	07 0652 98	chrom - rot chromé - rouge 1.08800.100.825	3		31.10	33.50



SIMILOR Ersatzteile

SIMILOR pièces de rechange

	EAN-Nr. <i>no EAN</i>	Artikel Nr. <i>no d'article</i>	Beschreibung <i>description</i>	VPE <i>ce</i>	VE <i>ue</i>	UVP pro Stk. PVC CHF excl.	UVP pro Stk. PVC CHF incl.
--	--------------------------	------------------------------------	------------------------------------	------------------	-----------------	-------------------------------------	-------------------------------------

Norm-Oberteil Kugler

Tête de robinet norme Kugler



7 612738 056131	07 0665 97	bis 1997 jusqu'à 1997 M20 x 1.25 ; 4.41156.901.701	1		29.25	31.50
7 611038 690465	07 0665 98	bis 1997 jusqu'à 1997 M20 x 1.25	5		45.03	48.50



Griff steckbar blau Kaltwasser

Poignée enfichable bleu



7 612738 076078	07 0667 96	bis 1997, chrom jusqu'à 1997, chromé 4.41300.100.820	1		36.21	39.—
7 611038 188443	07 0667 98	Silor bis 1997 Silor jusqu'à 1997 4.41300.100.820	5		38.53	41.50



Griff steckbar rot Warmwasser

Poignée enfichable rouge



7 612738 076085	07 0668 96	bis 1997, chrom jusqu'à 1997, chromé 4.41300.100.825	1		36.21	39.—
7 611038 188450	07 0668 98	Silor bis 1997 Silor jusqu'à 1997 4.41300.100.825	5		38.53	41.50



Oberteilpatrone C3

Tête de robinet cartouche C3



7 611038 690458	07 0655 98	zu Arwa Keramik pour Arwa céramique 9.61210.000.002	5		41.78	45.—
-----------------	------------	-----------------------------------------------------------	---	--	-------	------



SIMILOR Ersatzteile

SIMILOR pièces de rechange

	EAN-Nr. <i>no EAN</i>	Artikel Nr. <i>no d'article</i>	Beschreibung <i>description</i>	VPE <i>ce</i>	VE <i>ue</i>	UVP pro Stk. PVC CHF excl.	UVP pro Stk. PVC CHF incl.
--	--------------------------	------------------------------------	------------------------------------	------------------	-----------------	-------------------------------------	-------------------------------------

Oberteil zu Eckventilen

Chapeau pour robinet de régl.



7 612742 175316	75 6500 96	Messing blank <i>Laiton brut</i>	1		19.50	21.—
7 611038 690427	07 0650 98	zu SK Silor <i>pour SK Silor</i> M20 x 1.25	5		27.86	30.—



Ersatzteile

Pièces de rechange

	EAN-Nr. <i>no EAN</i>	Artikel Nr. <i>no d'article</i>	Beschreibung <i>description</i>	VPE <i>ce</i>	VE <i>ue</i>	UVP pro Stk. PVC CHF excl.	UVP pro Stk. PVC CHF incl.
--	--------------------------	------------------------------------	------------------------------------	------------------	-----------------	-------------------------------------	-------------------------------------

Oberteil

Tête de robinet



7 611038 102821	07 0494 96	für CH-Armaturen <i>pour CH-installations</i> M20 x 1,25 -CH ; RVZ 8 x 20 ZÄHNE	5		14.02	15.10
7 611038 690298	07 0510 98	für CH-Armaturen <i>pour CH-installations</i> M20 x 1,25	5		14.02	15.10

Kristallgriff blau m. Oberteil

Poignée cristal bleu avec tête



7 611038 690342	07 0532 98	transparent <i>transparente</i> M20x1 x 1.25	3		21.36	23.—
-----------------	------------	----------------------------------------------------	---	--	-------	------

Kristallgriff rot mit Oberteil

Poignée cristal rouge à tête



7 611038 690335	07 0530 98	transparent <i>transparente</i> M20x1 x 1.25	3		21.36	23.—
-----------------	------------	----------------------------------------------------	---	--	-------	------

Ersatzteile

Pièces de rechange

	EAN-Nr. <i>no EAN</i>	Artikel Nr. <i>no d'article</i>	Beschreibung <i>description</i>	VPE <i>ce</i>	VE <i>ue</i>	UVP pro Stk. PVC CHF excl.	UVP pro Stk. PVC CHF incl.
--	--------------------------	------------------------------------	------------------------------------	------------------	-----------------	-------------------------------------	-------------------------------------

Kristallgriff rot mit Rastbu.

Poignée cristal rouge



7 611038 102845	07 0498 96	transparent <i>transparente</i>	5		8.40	9.05
7 611038 690311	07 0520 98	Acryl, transparent <i>acrylique, transparente</i>	3		8.54	9.20

Kristallgriff blau mit Rastbu.

Poignée cristal bleu



7 611038 102838	07 0497 96	transparent <i>transparente</i>	5		8.40	9.05
7 611038 690328	07 0522 98	Acyl, transparent <i>acrylique, transparente</i>	3		8.54	9.20

3-Kant Griff, rot und blau

Poignée 3-bord, rouge et bleu



7 611038 678975	07 0491 98	verchromt <i>chromé</i>	3		8.96	9.65
-----------------	------------	----------------------------	---	--	------	------

Anschlussverschraubungen

Raccords

	EAN-Nr. <i>no EAN</i>	Artikel Nr. <i>no d'article</i>	Beschreibung <i>description</i>	VPE <i>ce</i>	VE <i>ue</i>	UVP pro Stk. PVC CHF excl.	UVP pro Stk. PVC CHF incl.
--	--------------------------	------------------------------------	------------------------------------	------------------	-----------------	-------------------------------------	-------------------------------------

Verschraubung gerade

Raccord droit



62 4001 98

Messing verchromt
Laiton chromé
3/8" x 1/2" x 55 mm*

3



13.74

14.80



62 4101 98

Messing verchromt
Laiton chromé
1/2" x 1/2" x 55 mm

3



16.81

18.10



62 4201 98

Messing verchromt
Laiton chromé
1/2" x 3/4" x 60 mm

3



16.71

18.—

* Keine SVGW Zertifizierung
* *pas de certificat SVGW*
mit Rosette
avec rosace
62 4500 94 / 62 4501 94



Verschraubung exzentrisch

Raccord excentrique



62 4117 98

Messing verchromt
Laiton chromé
1/2" x 1/2" x 68 mm ; 17 mm

3



26.93

29.—



mit Rosette
avec rosace
62 4503 94

Verschraubung exzentrisch

Raccord excentrique



62 4130 98

Messing verchromt
Laiton chromé
1/2" x 1/2" x 65 mm ; 30 mm

3



25.07

27.—



62 4230 98

Messing verchromt
Laiton chromé
1/2" x 3/4" x 68 mm ; 30 mm

3



29.71

32.—



mit Rosette
avec rosace
62 4501 94

Abstellverschraubung gerade

Raccord réglable droite



62 5101 98

Messing verchromt
Laiton chromé
1/2" x 1/2" x 62 mm

3



23.21

25.—



62 5201 98

Messing verchromt
Laiton chromé
1/2" x 3/4" x 65 mm

3



24.14

26.—



mit Rosette
avec rosace
62 4502 94

Anschlussverschraubungen

Raccords

	EAN-Nr. <i>no EAN</i>	Artikel Nr. <i>no d'article</i>	Beschreibung <i>description</i>	VPE <i>ce</i>	VE <i>ue</i>	UVP pro Stk. PVC CHF excl.	UVP pro Stk. PVC CHF incl.
--	--------------------------	------------------------------------	------------------------------------	------------------	-----------------	-------------------------------------	-------------------------------------

EURO Abstellverschraubung exzentrisch EURO Raccord réglable excentrique



7 611038 688325	62 5505 98	Messing verchromt <i>Laiton chromé</i> 1/2" x 3/4" x 69 mm ; 5 mm	1		29.25	31.50
-----------------	------------	-------------------------------------------------------------------------	---	--	-------	-------

Mit zwei Aussengewinden für Kompatibilität mit Armaturen europäischer Hersteller.
Avec deux filetages mâles pour une compatibilité avec les robinets de fabrication européennes.
 mit Rosette
avec rosace
 62 4502 94

Hahnrosette Rosace pour robinet



7 611038 678661	75 1580 98	Messing verchromt <i>laiton chromé</i> 3/8"	3		5.34	5.75
7 611038 678678	75 1581 98	Messing verchromt <i>laiton chromé</i> 1/2", H 8 mm ; Ø 21 / 58 mm	3		5.43	5.85

Hahnrosette Rosace pour robinet



7 611038 678685	75 1582 98	Messing verchromt <i>laiton chromé</i> 3/4"	3		5.52	5.95
-----------------	------------	---------------------------------------------------	---	--	------	------

zu Anschlussverschraubungen
pour raccords

Klapprosette ABS Rosace à charnière ABS



7 611038 678630	75 1590 98	verchromt <i>chromé</i> Ø 65 mm / Ø 18 mm / 6.5 mm ; 3/8"	3		5.85	6.30
-----------------	------------	-----------------------------------------------------------------	---	--	------	------

zu Anschlussverschraubungen
pour raccords

Anschlussverschraubungen

Raccords

	EAN-Nr. <i>no EAN</i>	Artikel Nr. <i>no d'article</i>	Beschreibung <i>description</i>	VPE <i>ce</i>	VE <i>ue</i>	UVP pro Stk. PVC CHF excl.	UVP pro Stk. PVC CHF incl.
--	--------------------------	------------------------------------	------------------------------------	------------------	-----------------	-------------------------------------	-------------------------------------

Klapprossette ABS

Rosace à charnière ABS



7 611038 678647	75 1591 98	verchromt <i>chromé</i> Ø 65 mm / Ø 22 mm / 6.5 mm ; 1/2"	3	1	5.94	6.40
-----------------	------------	--------------------------------------------------------------------	---	---	------	------

zu Anschlussverschraubungen
pour raccords

Klapprossette

Rosace à charnière



7 611038 678654	75 1592 98	verchromt <i>chromé</i> Ø 65 mm / Ø 27 mm / H 13 mm ; 3/4"	3	1	6.04	6.50
-----------------	------------	---------------------------------------------------------------------	---	---	------	------

zu Anschlussverschraubungen
pour raccords

Eck-Regulierventile Robinets de réglage d'angle

	EAN-Nr. no EAN	Artikel Nr. no d'article	Beschreibung description	VPE ce	VE ue	UVP pro Stk. PVC CHF excl.	UVP pro Stk. PVC CHF incl.
--	-------------------	-----------------------------	-----------------------------	-----------	----------	-------------------------------------	-------------------------------------

Eck-Regulierventil Robinet de réglage d'angle



62 3205 98

verchromt / kurz
chromé / court
3/8"

3



9.15

9.85

Für Waschtisch mit Säule.
Pour lavabo avec colonne.

Eck-Regulierventil Robinet de réglage d'angle



62 3210 98

verchromt / kurz
chromé / court
1/2"

3



8.54

9.20

Für Waschtisch mit Säule.
Pour lavabo avec colonne.

Eck-Regulierventil Robinet de réglage d'angle



62 3225 98

Messing verchromt
laiton chromé
3/8" ; 45 mm

3



20.43

22.—

verchromte Ausführung mit
Rosette
exécution chromé avec rosace
Klemmverschraubung:
Raccord bicône:
3/8" x 10mm

Eck-Regulierventil Robinet de réglage d'angle



62 3230 98

Messing verchromt
laiton chromé
1/2" ; 45 mm

3



18.20



19.60

verchromte Ausführung mit
Rosette
exécution chromé avec rosace
Klemmverschraubung:
Raccord bicône:
3/8" x 10mm

Eck-Regulierventile



Robinets de réglage d'angle

	EAN-Nr. no EAN	Artikel Nr. no d'article	Beschreibung description	VPE ce	VE ue	UVP pro Stk. PVC CHF excl.	UVP pro Stk. PVC CHF incl.
--	-------------------	-----------------------------	-----------------------------	-----------	----------	-------------------------------------	-------------------------------------

Eck-Regulierventil		Robinets de réglage d'angle					
	 7 611038 678487	62 3245 98	Messing verchromt laiton chromé 3/8" ; 75 mm	1		21.36	23.—











verchromte Ausführung mit Rosette
exécution chromé avec rosace
Klemmverschraubung:
Raccord bicône:
3/8" x 10mm

Eck-Regulierventil		Robinets de réglage d'angle					
	 7 611038 678494	62 3250 98	Messing verchromt laiton chromé 1/2" ; 75 mm	3		19.50	21.—



verchromte Ausführung mit Rosette
exécution chromé avec rosace
Klemmverschraubung:
Raccord bicône:
3/8" x 10mm

Eck-Regulierventil kurz		Robinets de réglage d'angle					
	 7 612742 163146	75 3000 96	Messing verchromt Laiton chromé 3/8" / 45 mm ; 1.04930.100.000	1		21.82	23.50
	 7 611038 678784	75 3000 98	Messing verchromt Laiton chromé 3/8" / 45 mm ; 1.04930.100.000	3		36.21	39.—
	 7 612742 163214	75 3100 96	Messing verchromt Laiton chromé 1/2" / 45 mm ; 1.04931.100.000	1		23.68	25.50
	 7 611038 678791	75 3100 98	Messing verchromt Laiton chromé 1/2" / 45 mm ; 1.04931.100.000	3		36.21	39.—



verchromte Ausführung mit Rosette
exécution chromé avec rosace
Klemmverschraubung:
Raccord bicône:
3/8" x 10mm

Eck-Regulierventile





Robinets de réglage d'angle

	EAN-Nr. no EAN	Artikel Nr. no d'article	Beschreibung description	VPE ce	VE ue	UVP pro Stk. PVC CHF excl.	UVP pro Stk. PVC CHF incl.
--	-------------------	-----------------------------	-----------------------------	-----------	----------	-------------------------------------	-------------------------------------

Eck-Regulierventil lang Robinets de réglage d'angle



verchromte Ausführung mit Rosette
exécution chromé avec rosace
Klemmverschraubung:
Raccord bicône:
3/8" x 10mm





	75 3300 96	Messing verchromt Laiton chromé 1/2" / 75 mm ; 1.04933.100.000	1		24.61	26.50
	75 3300 98	Messing verchromt Laiton chromé 1/2" / 75 mm ; 1.04933.100.000	1		39.—	42.—



Eck-Regulierventil kurz Robinets de réglage d'angle



Gewinde für Klemmverschchr.:
Filetage pour raccord bicône:
3/8"







	75 3501 96	Messing blank, o. Klemmverschchr Laiton brut, s. raccord bicône 1/2" / 70 mm ; 1.04935.901.421	10		18.11	19.50
	75 3501 98	Messing blank, o. Klemmverschchr Laiton brut, s. raccord bicône 1/2" / 70 mm ; 1.04935.901.421	10		34.35	37.—



Eck-Regulierventil kurz Robinets de réglage d'angle



Klemmverschraubung:
Raccord bicône:
3/8" x 10mm

	75 3400 96	Messing blank Laiton brut 3/8" / 70 mm ; 1.04934.901.420	10		21.82	23.50
	75 3400 98	Messing blank Laiton brut 3/8" / 70 mm ; 1.04934.901.420	1		35.28	38.—
	75 3500 96	Messing blank Laiton brut 1/2" / 70 mm ; 1.04935.901.420	10		20.89	22.50



Eck-Regulierventile Robinets de réglage d'angle

	EAN-Nr. <i>no EAN</i>	Artikel Nr. <i>no d'article</i>	Beschreibung <i>description</i>	VPE <i>ce</i>	VE <i>ue</i>	UVP pro Stk. PVC CHF excl.	UVP pro Stk. PVC CHF incl.
--	--------------------------	------------------------------------	------------------------------------	------------------	-----------------	-------------------------------------	-------------------------------------

SIDUO Doppelventil

SIDUO Robinet d'arrêt double

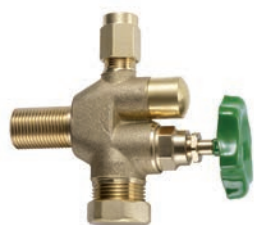

Klemmverschr.: 3/8" x 10mm
Abgang unten: 3/4"
Raccord bicône: 3/8" x 10mm
Raccord d'écoulement: 3/4"

7 611038 687571	75 4000 98	Messing blank <i>Laiton brut</i> 3/8" ; 1.04940.901.420	1		61.28	66.—
7 611038 687588	75 4100 98	Messing blank <i>Laiton brut</i> 1/2" ; 1.04941.901.420	3		62.21	67.—



Geschirrmaschinenventil

Robinet lave-vaisselle



Klemmverschr.: 3/8" x 10mm
Abgang unten: 3/4"
Raccord bicône: 3/8" x 10mm
Raccord d'écoulement: 3/4"

7 611038 008185	62 0025 98	Messing verchromt <i>Laiton chromé</i> 3/8"	3		41.32	44.50
7 611038 678999	62 0026 98	Messing verchromt <i>Laiton chromé</i> 3/8"	3		32.50	35.—
7 611038 008161	62 0023 98	Messing verchromt <i>Laiton chromé</i> 1/2"	3		41.32	44.50
7 611038 678616	62 0024 98	Messing verchromt <i>Laiton chromé</i> 1/2"	3		32.50	35.—



Geräteanschlussventile Raccordements de machines

	EAN-Nr. no EAN	Artikel Nr. no d'article	Beschreibung description	VPE ce	VE ue	UVP pro Stk. PVC CHF excl.	UVP pro Stk. PVC CHF incl.
--	-------------------	-----------------------------	-----------------------------	-----------	----------	-------------------------------------	-------------------------------------

Waschmaschinenventil

Robinet pour machine à laver



62 0032 98

Messing verchromt
Laiton chromé
1/2"

3



32.50

35.—



Mit Oberteil 1/2"
Kunststoffgriff
Avec chapeau 1/2"
Poignée plastique

Geräteanschlussventil

Robinet intercalaire



62 0076 98

Messing verchromt
Laiton chromé
3/8" x 10 mm

1



42.71

46.—



62 0077 98

Messing verchromt
Laiton chromé
3/8" x 10 mm

3



42.25

45.50



Mit Oberteil 3/8"
Kunststoffgriff
Avec chapeau 3/8"
poignée plastique

Batterieventil

Robinet Batterie



62 0033 98

Messing verchromt / blau
Laiton chromé / point bleu
1/2" ; rechts / droite

1



52.—

56.—



62 0035 98

Messing verchromt / blau
Laiton chromé / point bleu
1/2" ; rechts / droite

3



52.92

57.—



62 0034 98

Messing verchromt / blau
Laiton chromé / point bleu
3/4" ; rechts / droite

1



53.85

58.—



62 0036 98

Messing verchromt / blau
Laiton chromé / point bleu
3/4" ; rechts / droite

3



52.92

57.—



Mit Oberteil 1/2"
Avec chapeau 1/2"

Durchgangsventile Vanne de passage

	EAN-Nr. <i>no EAN</i>	Artikel Nr. <i>no d'article</i>	Beschreibung <i>description</i>	VPE <i>ce</i>	VE <i>ue</i>	UVP pro Stk. PVC CHF excl.	UVP pro Stk. PVC CHF incl.
--	--------------------------	------------------------------------	------------------------------------	------------------	-----------------	-------------------------------------	-------------------------------------

Durchgangsventil

Vanne de passage



7 611038 141523	75 1400 98	Messing blank <i>Laiton brut</i> 1/2"	3	1	17.64	19.—
7 611038 141530	75 1405 98	Messing blank <i>Laiton brut</i> 3/4"	3	1	21.82	23.50

Durchgangsventil m. Entleerung

Vanne de passage avec vidange



7 611038 678739	75 1410 98	Messing blank <i>Laiton brut</i> 1/2"	1	1	22.28	24.—
7 611038 678746	75 1415 98	Messing blank <i>Laiton brut</i> 3/4"	1	1	28.32	30.50

Kugelhahn

Robinet à boisseau sphérique



7 611038 678715	75 1421 98	Messing verchromt <i>Laiton chromé</i> 1/2"	5	1	10.86	11.70
7 611038 678722	75 1426 98	Messing verchromt <i>Laiton chromé</i> 3/4"	5	1	15.69	16.90

Mini-Kugelhahn







Robinet à boisseau sphérique



7 611038 678753	35 9050 98	Messing verchromt / IG x AG <i>laiton chromé / F x M</i> 3/8"	4	1	7.89	8.50
7 611038 678760	35 9051 98	Messing verchromt / IG x AG <i>laiton chromé / F x M</i> 1/2"	4	1	9.94	10.70
7 611038 678777	35 9052 98	Messing verchromt / IG x AG <i>laiton chromé / F x M</i> 3/4"	4	1	14.86	16.—

Duchgangsventile

Vanne de passage

	EAN-Nr. <i>no EAN</i>	Artikel Nr. <i>no d'article</i>	Beschreibung <i>description</i>	VPE <i>ce</i>	VE <i>ue</i>	UVP pro Stk. PVC CHF excl.	UVP pro Stk. PVC CHF incl.
Mini-Kugelhahn		Robinet à boisseau sphérique					
	 7 611038 171360	35 9070 98	Messing verchromt / IG x IG <i>laiton chromé / F x F</i> 3/8"	4	 1	7.89	8.50
	 7 611038 171377	35 9071 98	Messing verchromt / IG x IG <i>laiton chromé / F x F</i> 1/2"	4	 1	9.94	10.70
	 7 611038 171384	35 9072 98	Messing verchromt / IG x IG <i>laiton chromé / F x F</i> 3/4"	4	 1	14.86	16.—

Ablaufventile

Soupapes d'écoulement

	EAN-Nr. <i>no EAN</i>	Artikel Nr. <i>no d'article</i>	Beschreibung <i>description</i>	VPE <i>ce</i>	VE <i>ue</i>	UVP pro Stk. PVC CHF excl.	UVP pro Stk. PVC CHF incl.
--	--------------------------	------------------------------------	------------------------------------	------------------	-----------------	-------------------------------------	-------------------------------------

Siebventil Messing	Soupape à grille en laiton						
---------------------------	-----------------------------------	--	--	--	--	--	--



7 611038 678456	62 1506 98	mit Überlauf, verchromt <i>avec surverse, chromé</i> 1 1/4"	2	1	23.21	25.—
-----------------	------------	-------------------------------------------------------------------	---	---	-------	------

Schaftventil ohne Überlauf	Vidage avec plaque						
-----------------------------------	---------------------------	--	--	--	--	--	--



7 611038 678449	62 1606 98	verchromt, immer offen <i>sans surverse, chromé</i> 1 1/4" ; Ø 72 mm	2	1	43.18	46.50
-----------------	------------	----------------------------------------------------------------------------	---	---	-------	-------

Ablaufv. ClickClack Messing	Vidage ClickClack en laiton						
------------------------------------	------------------------------------	--	--	--	--	--	--



7 611038 678418	62 1621 98	mit Überlauf, verchromt <i>avec surverse, chromé</i> 1 1/4"	2	1	46.43	50.—
-----------------	------------	-------------------------------------------------------------------	---	---	-------	------

Wipphebelventil mit Überlauf	Soupape à levier						
-------------------------------------	-------------------------	--	--	--	--	--	--



7 611038 678401	62 1701 98	verchromt <i>avec surverse, chromé</i> 1 1/4"	3	1	36.68	39.50
-----------------	------------	-----------------------------------------------------	---	---	-------	-------

Ablaufventile

Soupapes d'écoulement

	EAN-Nr. <i>no EAN</i>	Artikel Nr. <i>no d'article</i>	Beschreibung <i>description</i>	VPE <i>ce</i>	VE <i>ue</i>	UVP pro Stk. PVC CHF excl.	UVP pro Stk. PVC CHF incl.
--	--------------------------	------------------------------------	------------------------------------	------------------	-----------------	-------------------------------------	-------------------------------------

Zugventil mit Überlauf

Soupape à tirette av. surverse



62 1705 98

verchromt
chromé
1 1/4"

1



53.85

58.—

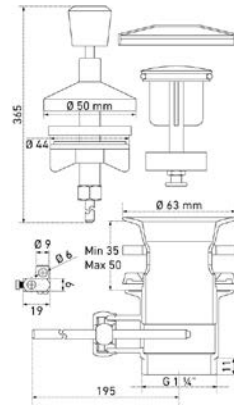

Kettenventil mit Überlauf

Soupape à chaînette à surverse



62 1710 98

verchromt
chromé
1 1/4"

1



23.21

25.—

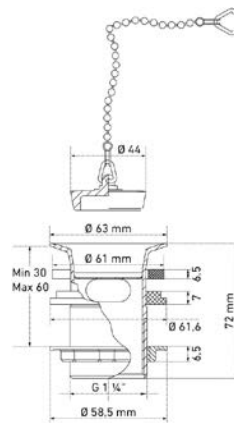

Ablaufventile

Soupapes d'écoulement

	EAN-Nr. <i>no EAN</i>	Artikel Nr. <i>no d'article</i>	Beschreibung <i>description</i>	VPE <i>ce</i>	VE <i>ue</i>	UVP pro Stk. PVC CHF excl.	UVP pro Stk. PVC CHF incl.
--	--------------------------	------------------------------------	------------------------------------	------------------	-----------------	-------------------------------------	-------------------------------------

Universal-Stopfen Bouchon universel



7 611038 678425	75 2000 98	verchromt <i>chromé</i> Ø 63.7 mm / 35.5 mm	3	1	19.50	21.—
-----------------	------------	---------------------------------------------------	---	---	-------	------

Mit grosser Abdeckplatte zur Überdeckung zerkratzter oder unschöner Ventilflansche. Passt in alle handelsüblichen Waschtisch-Ablaufventile.

Avec grande plaque de recouvrement pour cacher les flasques griffés. S'adapte à toutes soupapes usuelles.

Ventilstopfen Bouchon pour soupape



7 611038 678432	75 2004 98	Kunststoff verchromt <i>chromé</i> Ø 40 mm x 35 mm	5	1	7.47	8.05
-----------------	------------	----------------------------------------------------------	---	---	------	------

zu
pour
62 1701 98 & 62 1705 98

Ventilstopfen Snap Bouchon pour soupape Snap



7 611038 184933	75 2008 96	Kunststoff, verchromt <i>en matière synthétique, chromé</i> Ø 40 mm ; 65 - 80 mm	250	1	6.36	6.85
7 611038 469979	75 2008 98	Kunststoff, verchromt <i>en matière synthétique, chromé</i> Ø 40 mm ; 65 - 80 mm	5	1	6.36	6.85

zu
pour
62 1701 98 & 62 1705 98

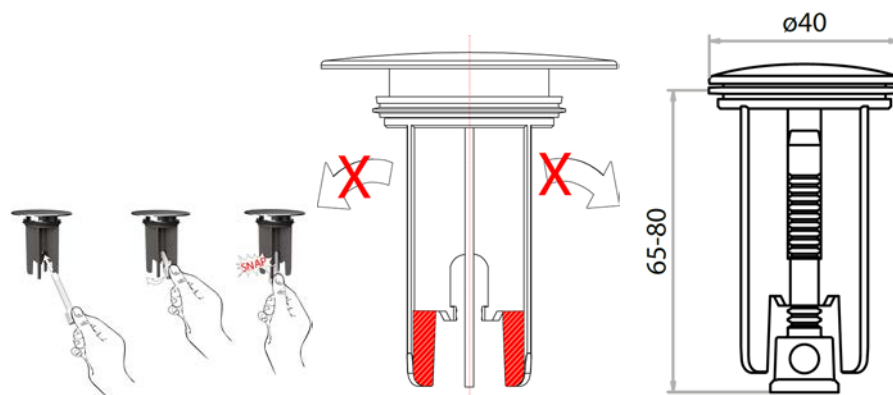

Ablaufventile

Soupapes d'écoulement

	EAN-Nr. <i>no EAN</i>	Artikel Nr. <i>no d'article</i>	Beschreibung <i>description</i>	VPE <i>ce</i>	VE <i>ue</i>	UVP pro Stk. PVC CHF excl.	UVP pro Stk. PVC CHF incl.
--	--------------------------	------------------------------------	------------------------------------	------------------	-----------------	-------------------------------------	-------------------------------------

NEW

Ventilstopfen Snap **Bouchon pour soupape Snap**



75 2010 98	Kunststoff, schwarz matt <i>matière synthétique, noir mat</i> Ø 63 mm ; 65 - 80 mm	5	1	29.25	31.50
------------	------------------------------------------------------------------------------------------	---	---	-------	-------

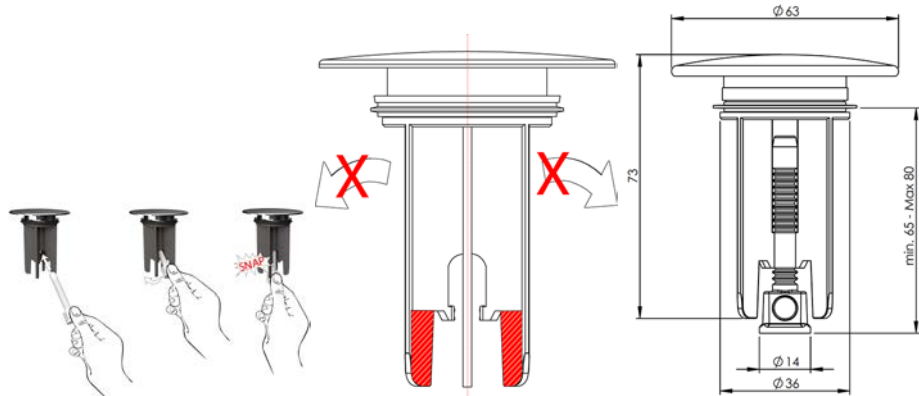

NEW

Ventilstopfen Snap **Bouchon pour soupape Snap**



75 2011 98	Kunststoff, weiss matt <i>matière synthétique, blanc mat</i> Ø 63 mm ; 65 - 80 mm	5	1	29.25	31.50
------------	-----------------------------------------------------------------------------------------	---	---	-------	-------

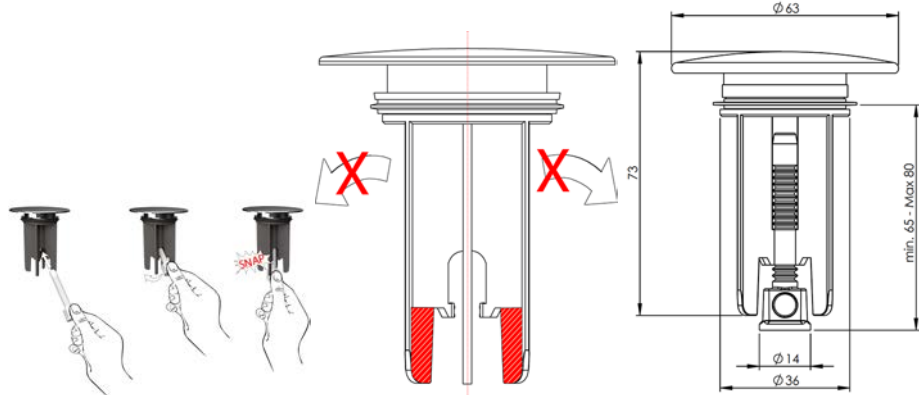

NEW

Ventilstopfen Snap **Bouchon pour soupape Snap**



75 2013 98	Kunststoff, Nickel gebürstet <i>matière synth., nickel brossé</i> Ø 63 mm ; 65 - 80 mm	5	1	29.25	31.50
------------	----------------------------------------------------------------------------------------------	---	---	-------	-------

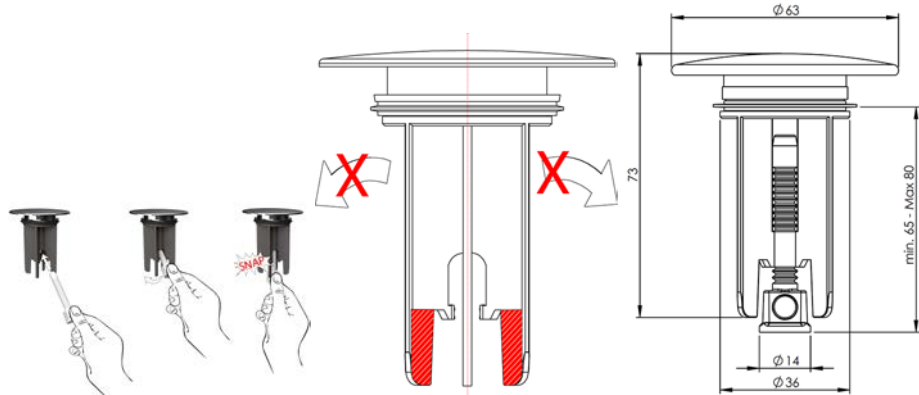

Ablaufventile

Soupapes d'écoulement

	EAN-Nr. <i>no EAN</i>	Artikel Nr. <i>no d'article</i>	Beschreibung <i>description</i>	VPE <i>ce</i>	VE <i>ue</i>	UVP pro Stk. PVC CHF excl.	UVP pro Stk. PVC CHF incl.
--	--------------------------	------------------------------------	------------------------------------	------------------	-----------------	-------------------------------------	-------------------------------------

Universalstopfen Funny	Bouchon pour soupape Funny
-------------------------------	-----------------------------------



7 611038 183899	75 2500 03	Smack <i>Smack</i> Ø 38 mm & 63 mm ; 2 Stk/pcs.	60	1	14.95	16.10
-----------------	------------	-------------------------------------------------------	----	---	-------	-------

- Mit zwei austauschbaren Abdeckungen
- Rückseitiger Magnet: Starker Halt, einfacher Austausch
- Schnelle und einfache Höheneinstellung
- *Avec deux capuchons interchangeables*
- *Aimant au dos: Forte emprise et facile à remplacer*
- *Réglage en hauteur simple et rapide*

Universalstopfen Funny	Bouchon pour soupape Funny
-------------------------------	-----------------------------------



7 611038 183905	75 2500 04	Katze <i>Chat</i> Ø 38 mm & 63 mm ; 2 Stk/pcs.	60	1	14.95	16.10
-----------------	------------	------------------------------------------------------	----	---	-------	-------

Universalstopfen Funny	Bouchon pour soupape Funny
-------------------------------	-----------------------------------



7 611038 183912	75 2500 05	Hund <i>Chien</i> Ø 38 mm & 63 mm ; 2 Stk/pcs.	60	1	14.95	16.10
-----------------	------------	------------------------------------------------------	----	---	-------	-------

Universalstopfen Funny	Bouchon pour soupape Funny
-------------------------------	-----------------------------------









7 611038 183929	75 2500 06	Man <i>Homme</i> Ø 38 mm & 63 mm ; 2 Stk/pcs.	48	1	14.95	16.10
-----------------	------------	-----------------------------------------------------	----	---	-------	-------

Ablaufventile

Soupapes d'écoulement





	EAN-Nr. <i>no EAN</i>	Artikel Nr. <i>no d'article</i>	Beschreibung <i>description</i>	VPE <i>ce</i>	VE <i>ue</i>	UVP pro Stk. PVC CHF excl.	UVP pro Stk. PVC CHF incl.
--	--------------------------	------------------------------------	------------------------------------	------------------	-----------------	-------------------------------------	-------------------------------------

Universalstopfen Funny		Bouchon pour soupape Funny					
	 7 611038 183998	75 2500 07	Lady Femme Ø 38 mm & 63 mm ; 2 Stk/pcs.	48	 1	14.95	16.10

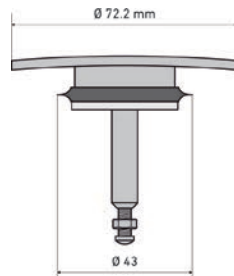
Stopfen für Badewannen		Bouchon pour baignoires					
	 7 611038 679040	75 2002 98	verchromt chromé Ø 72.2 / 43.0 mm	3	 1	16.16	17.40

Mit grosser Abdeckplatte zur Überdeckung zerkratzter oder unschöner Ventilflansche.
Avec grande plaque de recouvrement pour cacher les flasques griffés.



Hahnlochstopfen		Bouchon pour trou robinet					
	 7 611038 690274	35 2944 98	verchromt chromé Ø 44 mm ; 40 mm	4	 1	14.95	16.10
	 7 611038 690281	35 2952 98	verchromt chromé Ø 52 mm ; 40 mm	4	 1	21.36	23.—

Siphons

Siphons

	EAN-Nr. <i>no EAN</i>	Artikel Nr. <i>no d'article</i>	Beschreibung <i>description</i>	VPE <i>ce</i>	VE <i>ue</i>	UVP pro Stk. PVC CHF excl.	UVP pro Stk. PVC CHF incl.
--	--------------------------	------------------------------------	------------------------------------	------------------	-----------------	-------------------------------------	-------------------------------------

Waschtisch-Siphon ABS Siphon de lavabo ABS



7 611038 177577	75 1160 98	verchromt, mit Siphonverbinder chromé, avec connecteur 1¼" x Ø 32 mm	20		23.68	25.50
7 611038 177584	75 1165 98	verchromt, mit Siphonverbinder chromé, avec connecteur 1¼" x Ø 40 mm	20		26.46	28.50

Mit Revisionsdeckel zum Abschrauben.
Avec bouchon d'inspection à dévisser.

Waschtisch-Siphon Siphon de lavabo



7 611038 678302	75 0100 98	weiss blanc 1¼" x 32/46 mm	25		50.14	54.—
7 611038 678319	75 0101 98	verchromt chromé 1¼" x 32/46 mm	25		80.78	87.—

Mit Revisionsdeckel zum Abschrauben.
Avec bouchon d'inspection à dévisser.

Raumsparsiphon Siphon compact



7 611038 168544	75 0108 98	Kunststoff weiss plastique blanc 1¼" ; 40 mm	25		42.25	45.50
-----------------	------------	----------------------------------------------	----	--	-------	-------

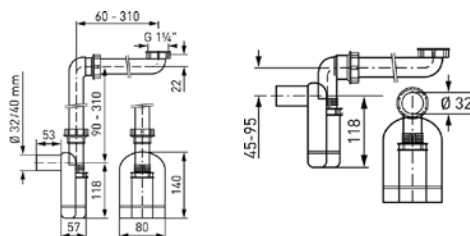

schlanke Bauform!
conception mince!

Siphons

Siphons

	EAN-Nr. <i>no EAN</i>	Artikel Nr. <i>no d'article</i>	Beschreibung <i>description</i>	VPE <i>ce</i>	VE <i>ue</i>	UVP pro Stk. PVC CHF excl.	UVP pro Stk. PVC CHF incl.
--	--------------------------	------------------------------------	------------------------------------	------------------	-----------------	-------------------------------------	-------------------------------------

Siphon f. WT Raumsparmodell



- raumsparend
- geeignet für Auszugsschubladen ohne Siphonausschnitt
- speziell für Waschtischunterbauten und behindertengerechte Waschtische
- gain de place
- idéal pour meubles inférieurs avec tiroirs sans découpe pour siphon
- idéal pour meubles inférieurs et lavabos accessibles aux handicapés



75 0140 96

weiss, mit Siphonverbinder
blanc, avec joint à emboîter
1¼" x Ø 32 mm

25



28.32

30.50



75 0145 96

weiss, mit Siphonverbinder
blanc, avec joint à emboîter
1¼" x Ø 40 mm

25



28.32

30.50



75 0145 98

weiss, mit Siphonverbinder
blanc, avec joint à emboîter
1¼" x Ø 40 mm

24



29.71

32.—

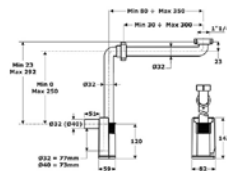
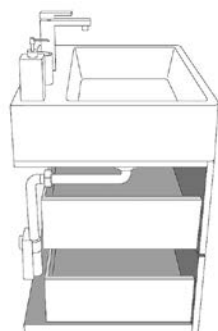

Siphons

Siphons

	EAN-Nr. <i>no EAN</i>	Artikel Nr. <i>no d'article</i>	Beschreibung <i>description</i>	VPE <i>ce</i>	VE <i>ue</i>	UVP pro Stk. PVC CHF excl.	UVP pro Stk. PVC CHF incl.
--	--------------------------	------------------------------------	------------------------------------	------------------	-----------------	-------------------------------------	-------------------------------------



Rohrbogen-Siphon

Siphon en tube

	 4 013341 008556	75 0152 96	Kunststoff weiss <i>plastique blanc</i> 1 1/4" ; 32 mm	1		16.16	17.40

Rohrbogensiphon



Siphon en tube coudé

	 7 611038 180478	75 0501 98	weiss <i>blanc</i> 5/8" , Ø 40 mm ; GEBERIT NO. 151.104.11.1	25		35.75	38.50

GEBERIT

Waschtischsiphon



Siphon de lavabo

	 7 611038 180454	75 0503 98	weiss <i>blanc</i> GEBERIT NO. 151.025.11.1 ; 5/8" , Ø 40 mm	25		46.43	50.—

GEBERIT

Waschtischsiphon

Siphon de lavabo

	 7 611038 180461	75 0502 98	verchromt <i>chromé</i> 5/8" ; Ø 40 mm / 151.025.21.1	25		70.57	76.—

GEBERIT

Siphons

Siphons

EAN-Nr. <i>no EAN</i>	Artikel Nr. <i>no d'article</i>	Beschreibung <i>description</i>	VPE <i>ce</i>	VE <i>ue</i>	UVP pro Stk. PVC CHF excl.	UVP pro Stk. PVC CHF incl.
--------------------------	------------------------------------	------------------------------------	------------------	-----------------	-------------------------------------	-------------------------------------

Siphon mit Geräteanschluss

Siphon avec raccord



9 003076 110049	75 0130 96	kunststoff weiss <i>plastique blanc</i> 1½" ; 40 mm	1		17.18	18.50
-----------------	------------	-----------------------------------------------------------	---	--	-------	-------

Siphon

Siphon



7 611038 678333	75 0102 98	Messing verchromt <i>laiton chromé</i> 1½" ; Ø 32 mm	25		45.96	49.50
7 611038 678357	75 0104 98	Messing verchromt <i>laiton chromé</i> 1½" ; Ø 40 mm	25		46.43	50.—

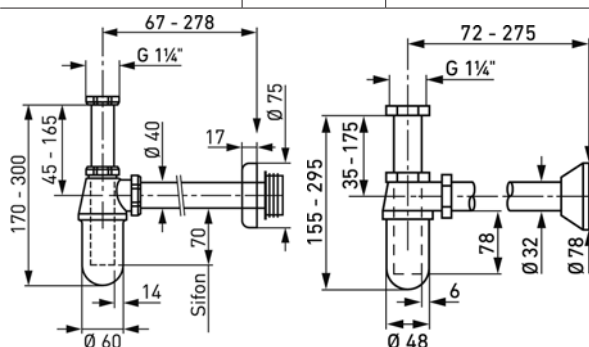

Formschönes Design,
schlanke Bauform!
*Design élégant
et une conception mince!*

Dichtungssset für Siphon

Set joint pour siphon



7 611038 182519	75 0112 96	1½" ; 40 mm / 60 mm	100		3.67	3.95
7 611038 182526	75 0113 96	1½" ; 32 mm / 50 mm	100		3.67	3.95

zu Siphon Messing verchromt
pour siphon en laiton chromé

Siphon-Rohr

Tube pour siphon



7 611038 678340	75 0103 98	Messing verchromt <i>laiton chromé</i> 25CM ; 32 mm	10		10.49	11.30
7 611038 678364	75 0105 98	Messing verchromt <i>laiton chromé</i> 25CM ; 40 mm	10		11.88	12.80

Siphons

Siphons

	EAN-Nr. <i>no EAN</i>	Artikel Nr. <i>no d'article</i>	Beschreibung <i>description</i>	VPE <i>ce</i>	VE <i>ue</i>	UVP pro Stk. PVC CHF excl.	UVP pro Stk. PVC CHF incl.
--	--------------------------	------------------------------------	------------------------------------	------------------	-----------------	-------------------------------------	-------------------------------------



Siphon-Abgangsrohr mit Bördel

Tube pour siphon avec borde

	 7 611038 472276	75 0121 98	Messing verchromt <i>laiton chromé</i> 25CM ; 32 mm	10		9.94	10.70
	 7 611038 472283	75 0122 98	Messing verchromt <i>laiton chromé</i> 30CM ; 32 mm	10		10.40	11.20





Siphon

Siphon

	 7 611038 678371	75 0106 98	kunststoff weiss <i>plastique blanc</i> 1½" ; 50 mm	1		21.36	23.—
-----------------------------------------------------------------------------------	---------------------------------------------------------------------------------------------------	------------	-----------------------------------------------------------	---	-------------------------------------------------------------------------------------	-------	------



Rohrbogen-Siphon mit GWA

Siphon en tube avec coude

	 4 013341 028295	75 0154 96	Kunststoff weiss <i>plastique blanc</i> 1½" ; 56 mm	1		15.04	16.20
	 7 611038 678265	75 0154 98	Kunststoff weiss <i>blanc</i> 1½" ; 56 mm	1		19.50	21.—

Flexibler, ausziehbarer Siphon

Siphon flexible et extensible

	 7 611038 182441	75 0135 96	PP weiss <i>PP blanc</i> 1½" Ø 40-50 mm ; L = 400-850 mm	10		34.35	37.—
-------------------------------------------------------------------------------------	-----------------------------------------------------------------------------------------------------	------------	-------------------------------------------------------------------	----	---------------------------------------------------------------------------------------	-------	------

Siphons

Siphons

	EAN-Nr. <i>no EAN</i>	Artikel Nr. <i>no d'article</i>	Beschreibung <i>description</i>	VPE <i>ce</i>	VE <i>ue</i>	UVP pro Stk. PVC CHF excl.	UVP pro Stk. PVC CHF incl.
--	--------------------------	------------------------------------	------------------------------------	------------------	-----------------	-------------------------------------	-------------------------------------

Küchensiphon 2-teilig

Siphon pour cuisine



4	 013341 051347	75 0150 96	Kunststoff weiss <i>plastique blanc</i> 1½"; 40 mm	1		20.89	22.50
---	-------------------------------------------------------------------------------------------------	------------	----------------------------------------------------------	---	-------------------------------------------------------------------------------------	-------	-------

Küchensiphon 2-teilig

Siphon pour cuisine 2 parts







4	 013341 074384	75 0151 96	Kunststoff weiss <i>plastique blanc</i> 1½"; 56 mm	1		37.60	40.50
---	-------------------------------------------------------------------------------------------------	------------	----------------------------------------------------------	---	-------------------------------------------------------------------------------------	-------	-------

Spültisch-Garnitur

Siphon pour évier





4	 025416 022022	75 0506 97	grau / 1-teilig <i>gris / 1 bac</i> 1½", Ø 56 mm ; GEBERIT 152.800.06.1	1		39.46	42.50
7	 611038 180515	75 0506 98	grau / 1-teilig <i>gris / 1 bac</i> 1½", Ø 56 mm ; GEBERIT 152.800.06.1	1		51.07	55.—

GEBERIT

Spültisch-Garnitur

Siphon pour évier



4	 025416 022046	75 0507 97	grau / 2-teilig <i>gris / 2 bacs</i> 1½", Ø 56 mm ; GEBERIT 152.804.06.1	1		59.42	64.—
7	 611038 180522	75 0507 98	grau / 2-teilig <i>gris / 2 bacs</i> 1½", Ø 56 mm ; GEBERIT 152.804.06.1	1		76.14	82.—

GEBERIT

Siphons



Siphons

	EAN-Nr. <i>no EAN</i>	Artikel Nr. <i>no d'article</i>	Beschreibung <i>description</i>	VPE <i>ce</i>	VE <i>ue</i>	UVP pro Stk. PVC CHF excl.	UVP pro Stk. PVC CHF incl.
--	--------------------------	------------------------------------	------------------------------------	------------------	-----------------	-------------------------------------	-------------------------------------

Rückstauklappe

Clapet anti-retour





4	 025416 052975	75 0530 96	für Spültischablauf <i>pour siphon d'évier</i> Ø 40 x 56 mm ; GEBERIT 252.666.11.1	10		13.83	14.90
---	-------------------------------------------------------------------------------------------------	------------	---------------------------------------------------------------------------------------------	----	-------------------------------------------------------------------------------------	-------	-------

GEBERIT

Siphon für Duschtasse

Sifon de douche







7	 611038 678326	75 0120 98	1½" ; Ø 40 / 50 mm	1		33.89	36.50
---	-------------------------------------------------------------------------------------------------	------------	--------------------	---	-------------------------------------------------------------------------------------	-------	-------

Duschwannenablauf Uniflex 50

Écoulement douche Uniflex 50







4	 025416 863779	75 0509 97	56 mm	1		70.57	76.—
7	 611038 180577	75 0509 98	56 mm	1		77.99	84.—

GEBERIT

Ablaufhaube Uniflex 50

Capot de couverture Uniflex 50



4	 025416 863809	75 0511 96	verchromt <i>chromé</i> Ø 80 mm ; GEBERIT 150.280.21.1	10		23.68	25.50
7	 611038 679057	75 0511 98	verchromt <i>chromé</i> Ø 80 mm ; GEBERIT 150.280.21.1	10		25.53	27.50

GEBERIT

Siphons

Siphons

	EAN-Nr. <i>no EAN</i>	Artikel Nr. <i>no d'article</i>	Beschreibung <i>description</i>	VPE <i>ce</i>	VE <i>ue</i>	UVP pro Stk. PVC CHF excl.	UVP pro Stk. PVC CHF incl.
--	--------------------------	------------------------------------	------------------------------------	------------------	-----------------	-------------------------------------	-------------------------------------

Duschwannenablauf Uniflex 90

Écoulement douche Uniflex 90



4	025416 633808	75 0510 97	56 mm	1		83.57	90.—
7	611038 180560	75 0510 98	56 mm	1		90.06	97.—

GEBERIT

Ablaufhaube Uniflex 90

Capot de couverture Uniflex 90



4	025416 815327	75 0512 96	verchromt, f. Modell 2006 – 17 <i>chromé, p. modèle 2006 – 17</i> Ø 115 mm ; GEBERIT 243.775.21.1	10		32.50	35.—
7	611038 679064	75 0512 98	verchromt <i>chromé</i> Ø 115 mm ; GEBERIT 243.775.21.1	3		39.46	42.50

GEBERIT

Ablaufhaube Uniflex 90 New

Capot de couverture Uniflex 90



4	025416 642114	75 0522 96	verchromt <i>chromé</i> Ø 115 mm ; GEBERIT 150.265.21.1	10		32.50	35.—
7	611038 175245	75 0522 98	verchromt <i>chromé</i> Ø 115 mm ; GEBERIT 150.265.21.1	3		37.60	40.50

ab 2017
à partir de 2017
GEBERIT

Wannengarnitur

Garniture de baignoire



4	025416 158042	75 0508 97	56 mm	1		120.71	130.—
7	611038 180553	75 0508 98	56 mm	3		130.92	141.—

GEBERIT





Siphons

Siphons

	EAN-Nr. <i>no EAN</i>	Artikel Nr. <i>no d'article</i>	Beschreibung <i>description</i>	VPE <i>ce</i>	VE <i>ue</i>	UVP pro Stk. PVC CHF excl.	UVP pro Stk. PVC CHF incl.
--	--------------------------	------------------------------------	------------------------------------	------------------	-----------------	-------------------------------------	-------------------------------------

Ab- und Überlaufset





Set de vidage et surverse

	 4 025416 161448	75 0513 96	verchromt <i>chromé</i>	1		40.85	44.—
	 7 611038 679071	75 0513 98	verchromt <i>chromé</i>	3		45.96	49.50

GEBERIT

Rohrbogensiphon PE-HD





Siphon en tube coudé PE-HD

	 4 025416 016755	75 0525 96	senkrecht/senkrecht <i>vertical/vertical</i> Ø 50/56 mm ; 152.041.16.1	1		55.66	59.95
	 7 611038 190279	75 0525 98	senkrecht/senkrecht <i>vertical/vertical</i> Ø 50/56 mm ; 152.041.16.1	1		64.95	69.95

GEBERIT

Rohrbogensiphon PE-HD



Siphon en tube coudé PE-HD

	 4 025416 016779	75 0526 96	senkrecht/waagrecht <i>vertical/horizontal</i> Ø 50/56 mm ; 152.043.16.1	1		55.66	59.95
	 7 611038 236915	75 0526 98	senkrecht/waagrecht <i>vertical/horizontal</i> Ø 50/56 mm ; 152.043.16.1	1		64.95	69.95

GEBERIT

Anschlussstutzen PE-HD

Tubulure de raccordement PE-HD

	 7 611038 236922	75 0527 98	mit Überwurfmutter u. Dichtung <i>avec écrou et joint</i> 1½" x Ø 50 mm ; 152.113.16.1	3		25.95	27.95
-------------------------------------------------------------------------------------	--------------------------------------------------------------------------------------------------------	------------	-------------------------------------------------------------------------------------------------	---	---------------------------------------------------------------------------------------	-------	-------

GEBERIT

Siphons



Siphons

	EAN-Nr. <i>no EAN</i>	Artikel Nr. <i>no d'article</i>	Beschreibung <i>description</i>	VPE <i>ce</i>	VE <i>ue</i>	UVP pro Stk. PVC CHF excl.	UVP pro Stk. PVC CHF incl.
--	--------------------------	------------------------------------	------------------------------------	------------------	-----------------	-------------------------------------	-------------------------------------

Stutzen

Manchon





4	 025416 092483	75 0515 96	PVC zum kleben <i>PVC à coller</i> 56/50 mm	3		31.10	33.50
---	-------------------------------------------------------------------------------------------------	------------	---------------------------------------------------	---	-------------------------------------------------------------------------------------	-------	-------

GEBERIT

Ablaufmanschette

Manchon de vidage





4	 025416 018582	75 0517 96	zu Standklosett LD <i>pour WC installation au sol</i> GEBERIT NO. 152.400.16.1	1		40.39	43.50
---	-------------------------------------------------------------------------------------------------	------------	--------------------------------------------------------------------------------------	---	-------------------------------------------------------------------------------------	-------	-------

GEBERIT

Ablaufmanschette

Manchon de vidage





4	 025416 018612	75 0520 96	UP <i>UP</i> 90 mm ; GEBERIT NO. 152.404.46.2	1		36.68	39.50
---	---------------------------------------------------------------------------------------------------	------------	--------------------------------------------------------	---	---------------------------------------------------------------------------------------	-------	-------

GEBERIT

Anschlussrohr

Raccordement avec manchon



4	 013341 017022	75 0160 96	Kunststoff schwarz <i>plastique noir</i> 250 mm ; 45 mm	1		13.18	14.20
---	---------------------------------------------------------------------------------------------------	------------	---------------------------------------------------------------	---	---------------------------------------------------------------------------------------	-------	-------

Spülbogen

Tuyau pour reservoir



4	 013341 004749	75 0161 96	Kunststoff weiss <i>plastique blanc</i> Ø 50 x 40 mm ; 20 x 21 CM	1		11.88	12.80
---	---------------------------------------------------------------------------------------------------	------------	-------------------------------------------------------------------------	---	---------------------------------------------------------------------------------------	-------	-------

Siphons

Siphons

	EAN-Nr. <i>no EAN</i>	Artikel Nr. <i>no d'article</i>	Beschreibung <i>description</i>	VPE <i>ce</i>	VE <i>ue</i>	UVP pro Stk. PVC CHF excl.	UVP pro Stk. PVC CHF incl.
--	--------------------------	------------------------------------	------------------------------------	------------------	-----------------	-------------------------------------	-------------------------------------

Übergangsstück

Pièce de jonction



7 611038 678289	75 0190 96	Kunststoff weiss <i>plastique blanc</i> 50-56 mm	1		24.61	26.50
-----------------	------------	--------------------------------------------------------	---	--	-------	-------

Abflussanschluss

Raccord d'écoulement



7 611038 687014	75 0194 98	Messing verchromt <i>laiton chromé</i> 1 1/4" x Ø19 mm	3		21.36	23.—
-----------------	------------	--------------------------------------------------------------	---	--	-------	------

Ersatzdichtung:
Joint de rechange:
78 4120 90

WAS-Anschluss

Raccord WAS



7 611038 687007	75 0193 98	kunststoff weiss <i>plastique blanc</i> 1" x 3/4" ; 90°	6		4.74	5.10
-----------------	------------	---------------------------------------------------------------	---	--	------	------

Abzweigstück

Élément de dérivation



7 611038 472290	75 0195 98	Kunststoff weiss <i>plastique blanc</i> 1" x Ø19-23MM	5		4.13	4.45
-----------------	------------	-------------------------------------------------------------	---	--	------	------

Reduzierung für Siphon

Reduction pour sifon



7 611038 678388	75 0191 98	Kunststoff weiss <i>plastique blanc</i> 1 1/2" x 1 1/4"	9		4.13	4.45
-----------------	------------	---------------------------------------------------------------	---	--	------	------

Siphons



Siphons

	EAN-Nr. <i>no EAN</i>	Artikel Nr. <i>no d'article</i>	Beschreibung <i>description</i>	VPE <i>ce</i>	VE <i>ue</i>	UVP pro Stk. PVC CHF excl.	UVP pro Stk. PVC CHF incl.
--	--------------------------	------------------------------------	------------------------------------	------------------	-----------------	-------------------------------------	-------------------------------------

Reduzierung für Siphon

Reduction pour sifon







	75 0192 98	Kunststoff weiss <i>plastique blanc</i> 1½" x 1½"	3		4.13	4.45
-----------------------------------------------------------------------------------	------------	---------------------------------------------------------	---	-------------------------------------------------------------------------------------	------	------

Ablaufschlauch Vario

Tuyau de vidange Vario







	66 1182 08	ausziehbar, gerade / gerade <i>extensible, droit / droit</i> Ø 19 mm ; 60 – 200 cm	1		17.83	19.20
	66 1183 08	ausziehbar, gerade / gerade <i>extensible, droit / droit</i> Ø 19 mm ; 90 – 300 cm	1		17.83	19.20

Ablaufschlauch Vario

Tuyau de vidange Vario



	66 1182 18	ausziehbar, gerade / gebogen <i>extensible, droit / coudé</i> Ø 19 mm ; 60 – 200 cm	1		17.83	19.20
	66 1183 18	ausziehbar, gerade / gebogen <i>extensible, droit / coudé</i> Ø 19 mm ; 90 – 300 cm	1		17.83	19.20

Ablaufschlauch



Tuyau de vidange



	66 1081 58	Ø 19 mm ; 150 cm	1		12.81	13.80
	66 1082 08	Ø 19 mm ; 200 cm	1		13.83	14.90
	66 1082 58	Ø 19 mm ; 250 cm	1		14.76	15.90
	66 1083 08	Ø 19 mm ; 300 cm	1		15.88	17.10

Siphons

Siphons

	EAN-Nr. <i>no EAN</i>	Artikel Nr. <i>no d'article</i>	Beschreibung <i>description</i>	VPE <i>ce</i>	VE <i>ue</i>	UVP pro Stk. PVC CHF excl.	UVP pro Stk. PVC CHF incl.
Schlauchbeschwerer		Poids pour tuyau de vidange					
		66 1090 98	Ø 19 mm / 3/4" ; 360 g	36		37.60	40.50

Gartenventile

Robinets de jardin

	EAN-Nr. <i>no EAN</i>	Artikel Nr. <i>no d'article</i>	Beschreibung <i>description</i>	VPE <i>ce</i>	VE <i>ue</i>	UVP pro Stk. PVC CHF excl.	UVP pro Stk. PVC CHF incl.
--	--------------------------	------------------------------------	------------------------------------	------------------	-----------------	-------------------------------------	-------------------------------------

SIGA Gartenventil	SIGA Robinet de jardin
--------------------------	-------------------------------



75 1189 98

Messing verchromt, mit Handrad
Laiton chromé, avec volant
1/2" / PN 16 ; 1.01011.002.902

5



67.78

73.—



Rosette nicht im Lieferumfang enthalten.
Rosace n'est pas inclu dans la livraison.

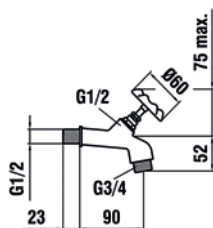

SIGA Gartenventil	SIGA Robinet de jardin
--------------------------	-------------------------------



75 1389 98

Messing chrom, mit Steckschl.
Laiton chr., avec clé amovible
1/2" ; PN 16

10



71.49

77.—



Rosette nicht im Lieferumfang enthalten.
Rosace n'est pas inclu dans la livraison.

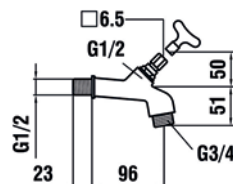

Gartenventil mit Handrad	Robinet de jardin avec volant
---------------------------------	--------------------------------------



75 1441 98

Messing verchromt
Laiton chromé
1/2" X 3/4" / Ø17MM

5



37.60

40.50

Gartenventile Robinets de jardin

	EAN-Nr. <i>no EAN</i>	Artikel Nr. <i>no d'article</i>	Beschreibung <i>description</i>	VPE <i>ce</i>	VE <i>ue</i>	UVP pro Stk. PVC CHF excl.	UVP pro Stk. PVC CHF incl.
--	--------------------------	------------------------------------	------------------------------------	------------------	-----------------	-------------------------------------	-------------------------------------

Auslaufventil, leicht

Robinet de fuite légerement



7 611038 678548	75 1466 98	Messing verchromt <i>Laiton chromé</i> 1/2" x 3/4" / Ø15 mm	5	1	14.67	15.80
-----------------	------------	-------------------------------------------------------------------	---	---	-------	-------

Auslaufventil, schwer

Robinet de fuite pénible



7 611038 678562	75 1471 98	Messing verchromt <i>Laiton chromé</i> 1/2" x 3/4"	5	1	22.28	24.—
-----------------	------------	----------------------------------------------------------	---	---	-------	------

Auslaufventil mit Schlüssel

Robinet de fuite avec clé



7 611038 678555	75 1475 98	Messing verchromt <i>Laiton chromé</i> 1/2" x 3/4"	10	1	24.14	26.—
-----------------	------------	----------------------------------------------------------	----	---	-------	------

Rosette nicht im Lieferumfang
enthalten.

*Rosace n'est pas inclu dans la
livraison.*

Steckschlüssel

Clé a tube



7 611038 160807	16 7100 98	Messing vernickelt <i>laiton nickelé</i> 6 mm	3	1	5.15	5.55
-----------------	------------	-----------------------------------------------------	---	---	------	------



Gartenventile Robinets de jardin

	EAN-Nr. <i>no EAN</i>	Artikel Nr. <i>no d'article</i>	Beschreibung <i>description</i>	VPE <i>ce</i>	VE <i>ue</i>	UVP pro Stk. PVC CHF excl.	UVP pro Stk. PVC CHF incl.
--	--------------------------	------------------------------------	------------------------------------	------------------	-----------------	-------------------------------------	-------------------------------------

Doppelauslaufventil

Robinet double





	75 1480 98	verchromt <i>Laiton chromé</i> 1/2" / 3/4"	1		52.92	57.—
-----------------------------------------------------------------------------------	------------	--------------------------------------------------	---	-------------------------------------------------------------------------------------	-------	------

Schlauchverschraubung

Raccord





	75 1491 98	Messing verchromt <i>laiton chromé</i> 3/4" ; 13 mm / 1/2"	3		4.22	4.55
-----------------------------------------------------------------------------------	------------	------------------------------------------------------------------	---	-------------------------------------------------------------------------------------	------	------

Schlauchraccord

Raccord à tuyaux















	16 2416 98	Messing blank <i>laiton brut</i> 3/4" x 16 mm	1		10.96	11.80
-------------------------------------------------------------------------------------	------------	-----------------------------------------------------	---	---------------------------------------------------------------------------------------	-------	-------









NEOMATIC

NEOMATIC





	EAN-Nr. <i>no EAN</i>	Artikel Nr. <i>no d'article</i>	Beschreibung <i>description</i>	VPE <i>ce</i>	VE <i>ue</i>	UVP pro Stk. PVC CHF excl.	UVP pro Stk. PVC CHF incl.
--	--------------------------	------------------------------------	------------------------------------	------------------	-----------------	-------------------------------------	-------------------------------------

Kupplungssatz		Jeu d'accouplement					
		12 1000 98	Messing verchromt <i>Laiton chromé</i> 3/8" / 1/2" / 3/4" ; 13 mm	5		29.25	31.50
		12 1010 98	Messing verchromt <i>Laiton chromé</i> 3/8" / 1/2" / 3/4" ; 16 mm	5		29.25	31.50
		12 1020 98	Messing verchromt <i>Laiton chromé</i> 3/8" / 1/2" / 3/4" ; 19 mm	5		32.50	35.—

Kupplung		Accoupleur					
		12 1050 98	Messing verchromt <i>Laiton chromé</i> 3/4" ; Ø 16.5 mm	5		22.75	24.50
		12 1051 98	Messing verchromt <i>Laiton chromé</i> 3/4" ; Ø 16.5 mm	5		22.28	24.—

Kupplung		Accoupleur					
		12 1060 98	Messing verchromt <i>Laiton chromé</i> 3/8" / 1/2" / 3/4" ; Ø 16.5 mm	5		22.75	24.50
		12 1061 98	Messing verchromt <i>Laiton chromé</i> 3/8" / 1/2" / 3/4" ; Ø 16.5 mm	5		22.28	24.—
		12 1070 98	Messing verchromt <i>Laiton chromé</i> M22x1 / 1/2" / 3/4" ; Ø 16.5 mm	5		22.75	24.50
		12 1071 98	Messing verchromt <i>Laiton chromé</i> M22x1 / 1/2" / 3/4" ; Ø 16.5 mm	5		22.28	24.—

mit Reduktion
avec réduction

Ventilkupplung		Accoupleur à clapet					
		12 1100 98	Messing verchromt <i>Laiton chromé</i> 3/4" ; Ø 16.5 mm	5		33.43	36.—
		12 1101 98	Messing verchromt <i>Laiton chromé</i> 3/4" ; Ø 16.5 mm	5		32.96	35.50

NEOMATIC

NEOMATIC

	EAN-Nr. <i>no EAN</i>	Artikel Nr. <i>no d'article</i>	Beschreibung <i>description</i>	VPE <i>ce</i>	VE <i>ue</i>	UVP pro Stk. PVC CHF excl.	UVP pro Stk. PVC CHF incl.
--	--------------------------	------------------------------------	------------------------------------	------------------	-----------------	-------------------------------------	-------------------------------------

Schlauchkupplung

Accoupleur à tuyaux



4	005897 900507	12 1110 98	Messing verchromt <i>Laiton chromé</i> 13 mm ; Ø 16.5 mm	5		25.53	27.50
7	611038 679125	12 1111 98	Messing verchromt <i>Laiton chromé</i> 13 mm ; Ø 16.5 mm	5		25.07	27.—
4	005897 900606	12 1120 98	Messing verchromt <i>Laiton chromé</i> 16 mm ; Ø 16.5 mm	5		25.53	27.50
7	611038 679132	12 1121 98	Messing verchromt <i>Laiton chromé</i> 16 mm ; Ø 16.5 mm	5		25.07	27.—

Schlauchstecker

Raccord à tuyaux



4	005897 900705	12 1500 98	Messing verchromt <i>Laiton chromé</i> 11 mm ; Ø 16.5 mm	5		9.94	10.70
4	005897 900804	12 1510 98	Messing verchromt <i>Laiton chromé</i> 13 mm ; Ø 16.5 mm	5		7.99	8.60
7	611038 679149	12 1511 98	Messing verchromt <i>Laiton chromé</i> 13 mm ; Ø 16.5 mm	5		7.80	8.40
4	005897 900903	12 1520 98	Messing verchromt <i>Laiton chromé</i> 16 mm ; Ø 16.5 mm	5		7.06	7.60
4	005897 901009	12 1530 98	Messing verchromt <i>Laiton chromé</i> 19 mm ; Ø 16.5 mm	5		8.96	9.65

Kupplungsrippel

Raccord femelle







4	005897 901108	12 1600 98	Messing verchromt <i>Laiton chromé</i> 3/8" ; Ø 16.5 mm	5		8.68	9.35
4	005897 901207	12 1610 98	Messing verchromt <i>Laiton chromé</i> 1/2" ; Ø 16.5 mm	5		7.89	8.50
4	005897 901306	12 1620 98	Messing verchromt <i>Laiton chromé</i> 3/4" ; Ø 16.5 mm	5		7.89	8.50
4	005897 901405	12 1630 98	Messing verchromt <i>Laiton chromé</i> M22x1 ; Ø 16.5 mm	5		7.89	8.50







NEOMATIC

NEOMATIC

	EAN-Nr. <i>no EAN</i>	Artikel Nr. <i>no d'article</i>	Beschreibung <i>description</i>	VPE <i>ce</i>	VE <i>ue</i>	UVP pro Stk. PVC CHF excl.	UVP pro Stk. PVC CHF incl.
Kupplungsrippel		Raccord mâle					
		12 1710 98	Messing verchromt <i>Laiton chromé</i> 3/8" ; Ø 16.5 mm	5		7.89	8.50
		12 1720 98	Messing verchromt <i>Laiton chromé</i> 1/2" ; Ø 16.5 mm	5		7.89	8.50
		12 1721 98	Messing verchromt <i>Laiton chromé</i> 1/2" ; Ø 16.5 mm	5		7.71	8.30
		12 1730 98	Messing verchromt <i>Laiton chromé</i> 3/4" ; Ø 16.5 mm	5		7.89	8.50
		12 1731 98	Messing verchromt <i>Laiton chromé</i> 3/4" ; Ø 16.5 mm	5		7.71	8.30
		12 1740 98	Messing verchromt <i>Laiton chromé</i> M22x1 ; Ø 16.5 mm	5		7.89	8.50

Kupplungsrippel mit RV		Raccord avec clapet de retenue					
		12 1750 98	Messing verchromt <i>Laiton chromé</i> 1/2" ; Ø 16.5 mm	5		8.87	9.55
		12 1760 98	Messing verchromt <i>Laiton chromé</i> 3/4" ; Ø 16.5 mm	5		9.94	10.70

mit Rückflussverhinderer
avec clapet de retenue

Schlauchrohr		Raccord à tuyaux					
		12 1810 98	Messing verchromt <i>Laiton chromé</i> 3/4" x 13 mm	1		8.31	8.95
		12 1820 98	Messing verchromt <i>Laiton chromé</i> 3/4" x 16 mm	5		8.31	8.95
		12 1830 98	Messing verchromt <i>Laiton chromé</i> 3/4" x 19 mm	5		9.38	10.10

NEOMATIC

NEOMATIC

	EAN-Nr. <i>no EAN</i>	Artikel Nr. <i>no d'article</i>	Beschreibung <i>description</i>	VPE <i>ce</i>	VE <i>ue</i>	UVP pro Stk. PVC CHF excl.	UVP pro Stk. PVC CHF incl.
--	--------------------------	------------------------------------	------------------------------------	------------------	-----------------	-------------------------------------	-------------------------------------

NEOPERL® Strahlregler

NEOPERL® Aérateur



4		12 2000 98	Messing verchromt <i>Laiton chromé</i> Ø 16.5 mm	5		13.74	14.80
7		12 2001 98	Messing verchromt <i>Laiton chromé</i> Ø 16.5 mm	5		13.46	14.50

Doppelkupplungs-nippel

Raccord double



4		12 2350 98	Messing verchromt <i>Laiton chromé</i> Ø 16.5 mm	5		14.48	15.60
---	--	------------	--------------------------------------------------------	---	--	-------	-------

Y-Abzweigstück

Raccord en Y



4		12 2300 98	Messing verchromt <i>Laiton chromé</i> 2 x 3/4" ; Ø 16.5 mm	5		41.78	45.—
---	--	------------	-------------------------------------------------------------------	---	--	-------	------



NEOMATIC NEOMATIC

	EAN-Nr. <i>no EAN</i>	Artikel Nr. <i>no d'article</i>	Beschreibung <i>description</i>	VPE <i>ce</i>	VE <i>ue</i>	UVP pro Stk. PVC CHF excl.	UVP pro Stk. PVC CHF incl.
--	--------------------------	------------------------------------	------------------------------------	------------------	-----------------	-------------------------------------	-------------------------------------

Wasch-/Spülmaschinen Set

Set pour machine à laver



	12 3150 98	Messing verchromt <i>Laiton chromé</i> M24 / 3/4" / Ø16.5 mm / 3/4" ; 3/8" - 1/2" - 3/4" / Ø16.5 mm / M22	5		38.53	41.50
-----------------------------------------------------------------------------------	------------	--------------------------------------------------------------------------------------------------------------------	---	-------------------------------------------------------------------------------------	-------	-------

Inhalt:

- 1x Kupplung mit Reduktion
3/8" / 1/2" / 3/4" Art. 12106097
- 1x Reduktion M24x1 x 3/4"
Art. 50051094
- 1x Kupplungsstück 3/4" mit
Rückflussverhinderer
Art. 12176097
- 1x NEOPERL® Strahlregler
Art. 12200097



Contenu:

- 1x Accoupleur avec réduction
3/8" / 1/2" / 3/4" art. 12106097
- 1x Réduction M24x1 x 3/4"
art. 50051094
- 1x Raccord 3/4" avec clapet de
retenue art. 12176097
- 1x NEOPERL® Aérateur
art. 12200097

Strahlrohr

Lance





	12 2200 98	schwarz <i>noir</i> Ø 16.5 mm	5		26.93	29.—
-------------------------------------------------------------------------------------	------------	-------------------------------------	---	---------------------------------------------------------------------------------------	-------	------

Strahlrohr

Lance





	12 2250 98	Messing verchromt <i>Laiton chromé</i> Ø 16.5 mm	20		35.75	38.50
-------------------------------------------------------------------------------------	------------	--------------------------------------------------------	----	---------------------------------------------------------------------------------------	-------	-------

Übergangsstück

Pièce de jonction



	12 2360 98	Messing verchromt <i>Laiton chromé</i> Ø 16.5 mm	5		11.79	12.70
-------------------------------------------------------------------------------------	------------	--------------------------------------------------------	---	---------------------------------------------------------------------------------------	-------	-------

Passend zu den meisten
Kunststoffsystemen
*Adaptable à la plupart des
systèmes en matière synthétique*

NEOMATIC

NEOMATIC

	EAN-Nr. <i>no EAN</i>	Artikel Nr. <i>no d'article</i>	Beschreibung <i>description</i>	VPE <i>ce</i>	VE <i>ue</i>	UVP pro Stk. PVC CHF excl.	UVP pro Stk. PVC CHF incl.
--	--------------------------	------------------------------------	------------------------------------	------------------	-----------------	-------------------------------------	-------------------------------------

Bride

Collier



Komplett aus verzinktem Stahl.
Höhere Rostbeständigkeit.
*Complètement en Acier zingué.
Forte résistance à la corrosion.*

7 611038 689452	13 7510 98	verzinkt zingué 8-16 mm, 9 mm ; 4 Stk./PCS.	3		4.97	5.35
7 611038 689469	13 7511 98	verzinkt zingué 12-22 mm, 9 mm ; 4 Stk./PCS.	3		5.34	5.75
4 005897 940206	12 2550 98	Stahlband à 2 Stk. bande acier à 2 pcs. 12 - 20 mm ; 9 mm	5		5.06	5.45
7 611038 689476	13 7512 98	verzinkt zingué 16-27 mm, 9 mm ; 4 Stk./PCS.	3		5.62	6.05
4 005897 940305	12 2560 98	Stahlband à 2 Stk. bande acier à 2 pcs. 16 - 27 mm ; 9 mm	5		4.83	5.20
4 005897 940404	12 2570 98	Stahlband à 2 Stk. bande acier à 2 pcs. 25 - 40 mm ; 12 mm	5		5.29	5.70

Y-Abzweigstück kurz

Y-Distributeur court



7 611038 249847	16 7005 98	Messing verchromt laiton chromé 3/4"	3		12.91	13.90
-----------------	------------	--------------------------------------------	---	--	-------	-------

Y-Abzweigstück abstellbar

Raccord Y avec 2 robinets



7 611038 688332	16 7010 98	Messing blank Laiton brut 3/4"	5		28.32	30.50
-----------------	------------	--------------------------------------	---	--	-------	-------

NEOMATIC NEOMATIC

	EAN-Nr. <i>no EAN</i>	Artikel Nr. <i>no d'article</i>	Beschreibung <i>description</i>	VPE <i>ce</i>	VE <i>ue</i>	UVP pro Stk. PVC CHF excl.	UVP pro Stk. PVC CHF incl.
--	--------------------------	------------------------------------	------------------------------------	------------------	-----------------	-------------------------------------	-------------------------------------

Spritzpistole

Pistolet



11 5010 98

5



76.14

82.—

Max. 6 bar bei max.
40° Wassertemperatur.
Max. 4 bar bei max.
60° Wassertemperatur.
*Maxi. 6 bar pour une température
de l'eau à 40°.
Maxi. 4 bar pour une température
de l'eau à 60°.*

Basishandgriff mit Strahlrohr

Poignée de base avec lance



11 5017 98

5



105.85

114.—

Max. 6 bar bei max.
40° Wassertemperatur.
Max. 4 bar bei max.
60° Wassertemperatur.
*Maxi. 6 bar pour une température
de l'eau à 40°.
Maxi. 4 bar pour une température
de l'eau à 60°.*

NEOMATIC

NEOMATIC

	EAN-Nr. <i>no EAN</i>	Artikel Nr. <i>no d'article</i>	Beschreibung <i>description</i>	VPE <i>ce</i>	VE <i>ue</i>	UVP pro Stk. PVC CHF excl.	UVP pro Stk. PVC CHF incl.
--	--------------------------	------------------------------------	------------------------------------	------------------	-----------------	-------------------------------------	-------------------------------------

Basishandgriff kurz

Poignée de base courte



5 702210 000096

11 5015 98

5



87.28

94.—

Max. 6 bar bei max.
40° Wassertemperatur.
Max. 4 bar bei max.
60° Wassertemperatur.
*Maxi. 6 bar pour une température
de l'eau à 40°.
Maxi. 4 bar pour une température
de l'eau à 60°.*

Strahlrohr zu Basishandgriff

Lance pour poignée de base



5 702215 710198

11 5025 98

5



28.32

30.50

Gießstab

Lance arrosoir



5 702210 001093

11 5040 98

66 cm

5



69.64

75.—

Giesskopf mit Kupplungsstück

Pomme arrosoir a. tête raccord



5 702210 000195

11 5047 98

Aluminium
aluminium

10



52.92



57.—

NEOMATIC NEOMATIC

EAN-Nr. <i>no EAN</i>	Artikel Nr. <i>no d'article</i>	Beschreibung <i>description</i>	VPE <i>ce</i>	VE <i>ue</i>	UVP pro Stk. PVC CHF excl.	UVP pro Stk. PVC CHF incl.
--------------------------	------------------------------------	------------------------------------	------------------	-----------------	-------------------------------------	-------------------------------------

Gartendusche Simple

Douche à jardin Simple

	 7 611038 188290	14 0110 97	Edelstahl <i>inox</i> 210 cm / 38 cm	1		181.99	196.—
-----------------------------------------------------------------------------------	------------------------------------------------------------------------------------------------------	------------	--------------------------------------------	---	-------------------------------------------------------------------------------------	--------	-------

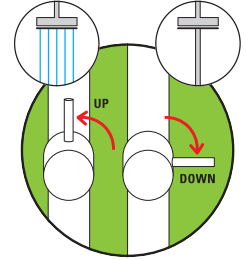
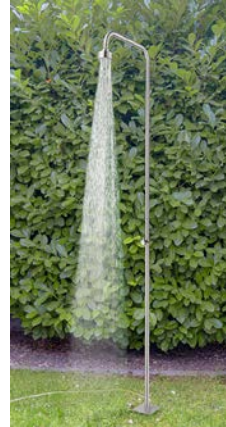
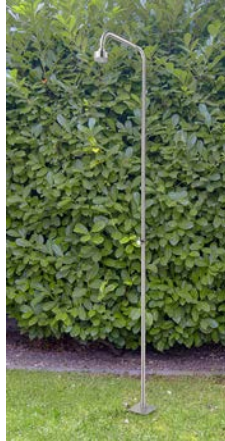
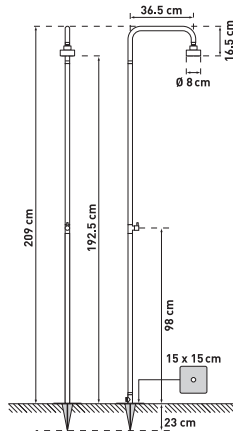



Mobile Gartendusche aus rostfrei gebürstetem Stahl, für die freie Positionierung auf dem Rasen, praktischer Steckdorn zum direkten Einstecken. 1/2" Anschlussgewinde für den Anschluss an den Gartenschlauch. Inkl. Kopfbrause Ø 80 mm und Umstellventil. Alles vorgefertigt für eine einfache Montage.



Douche de jardin mobile en acier inoxydable brossé, pour un positionnement libre sur la pelouse, broche pratique pour une insertion directe. Filetage de raccordement 1/2" pour le raccordement au tuyau d'arrosage. Comprend une douche de tête Ø 80 mm et une vanne de dérivation. Tout est préfabriqué pour une installation facile.







Fittinge Messing



Pièces de raccord en laiton







	EAN-Nr. <i>no EAN</i>	Artikel Nr. <i>no d'article</i>	Beschreibung <i>description</i>	VPE <i>ce</i>	VE <i>ue</i>	UVP pro Stk. PVC CHF excl.	UVP pro Stk. PVC CHF incl.
--	--------------------------	------------------------------------	------------------------------------	------------------	-----------------	-------------------------------------	-------------------------------------

Reduktion		Réduction						
			50 5080 98	Messing verchromt / IG x AG <i>laiton chromé / F x M</i> M24x1 x M28x1	3		16.16	17.40

Doppelnippel zylindrisch		Mamelon double cylindrique						
			50 7430 98	Messing verchromt <i>Laiton chromé</i> 3/4" x 3/8"	3		5.94	6.40

Verschlusskappe 6-kant		Bouchon femelle 6 pans						
			50 9011 98	Messing blank <i>Laiton brut</i> 3/8"	3		5.94	6.40
			50 9021 98	Messing blank <i>Laiton brut</i> 1/2"	3		4.97	5.35
			50 9031 98	Messing blank <i>laiton brut</i> 3/4"	3		5.39	5.80

Verschlusskappe 6-kant		Bouchon femelle 6 pans						
			50 9120 98	Messing verchromt <i>Laiton chromé</i> 1/2"	1		16.43	17.70

Abschlusszapfen 6-kant		Bouchon mâle 6 pans						
			50 9211 98	Messing blank <i>Laiton brut</i> 3/8"	3		2.74	2.95
			50 9221 98	Messing blank <i>Laiton brut</i> 1/2"	3		3.30	3.55
			50 9231 98	Messing blank <i>Laiton brut</i> 3/4"	3		3.85	4.15

Fittinge Messing

Pièces de raccord en laiton

	EAN-Nr. no EAN	Artikel Nr. no d'article	Beschreibung description	VPE ce	VE ue	UVP pro Stk. PVC CHF excl.	UVP pro Stk. PVC CHF incl.
--	-------------------	-----------------------------	-----------------------------	-----------	----------	-------------------------------------	-------------------------------------

Abschlusszapfen ohne Rosette

Bouchon mâle sans rosace



7 611038 689872	50 9411 98	Messing blank Laiton brut 3/8"	8	1	3.90	4.20
7 611038 689889	50 9421 98	Messing blank Laiton brut 1/2"	10	1	4.50	4.85
7 611038 689896	50 9431 98	Messing blank Laiton brut 3/4"	1	1	5.39	5.80

Hahnrosette

Rosace pour robinet



7 611038 678678	75 1581 98	Messing verchromt laiton chromé 1/2", H 8 mm ; Ø 21 / 58 mm	3	1	5.43	5.85
-----------------	------------	-------------------------------------------------------------------	---	---	------	------

Abschlusszapfen mit Rosette

Bouchon mâle avec rosace



7 611038 503659	50 9410 98	Messing verchromt Laiton chromé 3/8" ; Ø 60 mm	10	1	16.43	17.70
7 611038 503666	50 9420 98	Messing verchromt Laiton chromé 1/2" ; Ø 60 mm	1	1	16.43	17.70
7 611038 503673	50 9430 98	Messing verchromt laiton chromé 3/4" ; Ø 60 mm	1	1	23.21	25.—

Durchfluss-Rohrbelüfter

Prise antisiphonnage



7 611038 175252	58 1550 98	Messing verchromt Laiton chromé 3/4"	1	1	45.50	49.—
-----------------	------------	--------------------------------------------	---	---	-------	------

Fittinge Messing

Pièces de raccord en laiton

	EAN-Nr. <i>no EAN</i>	Artikel Nr. <i>no d'article</i>	Beschreibung <i>description</i>	VPE <i>ce</i>	VE <i>ue</i>	UVP pro Stk. PVC CHF excl.	UVP pro Stk. PVC CHF incl.
--	--------------------------	------------------------------------	------------------------------------	------------------	-----------------	-------------------------------------	-------------------------------------

Winkel IG x IG

Coude F x F



7 611038 688530	50 9865 98	Messing verchromt <i>laiton chromé</i> 1/2"	1		7.52	8.10
7 611038 688417	50 9870 98	Messing verchromt <i>laiton chromé</i> 3/4"	1		10.03	10.80

Winkel IG x AG

Coude F x M



7 611038 688424	50 9890 98	Messing verchromt <i>laiton chromé</i> 3/4"	1		11.23	12.10
-----------------	------------	---------------------------------------------------	---	--	-------	-------













Reduzierstück konisch ISO 7/1

Réduction conique ISO 7/1













7 611038 503468	50 8600 98	Messing blank <i>Laiton brut</i> 3/8" x 1/4"	1		5.34	5.75
7 611038 503475	50 8605 98	Messing blank <i>Laiton brut</i> 1/2" x 1/4"	1		9.29	10.—
7 611038 503482	50 8610 98	Messing blank <i>Laiton brut</i> 1/2" x 3/8"	1		7.29	7.85
7 611038 503499	50 8620 98	Messing blank <i>Laiton brut</i> 3/4" x 3/8"	1		12.53	13.50

ROTGUSS BRONZE

	EAN-Nr. <i>no EAN</i>	Artikel Nr. <i>no d'article</i>	Beschreibung <i>description</i>	VPE <i>ce</i>	VE <i>ue</i>	UVP pro Stk. PVC CHF excl.	UVP pro Stk. PVC CHF incl.
Hahnenverlängerung		Rallonge					
 <p>IG + AG = zylindrisch F + M = cylindrique</p>		72 1210 98	Rotguss verchromt <i>Bronze chromé</i> ½" x 10 mm ; 2 Stk/pcs	1		13.56	14.60
		72 1211 98	Rotguss verchromt <i>Bronze chromé</i> ½" x 10 mm	3		4.69	5.05
		72 1221 98	Rotguss verchromt <i>bronze chromé</i> ½" x 20 mm	3		4.36	4.70
		72 1230 98	Rotguss verchromt <i>bronze chromé</i> ½" x 30 mm ; 2 Stk/pcs	1		20.43	22.—
		72 1231 98	Rotguss verchromt <i>bronze chromé</i> ½" x 30 mm	3		6.45	6.95
		72 1250 98	Rotguss verchromt <i>Bronze chromé</i> ½" x 50 mm ; 1 Stk/pc	1		14.11	15.20



	Mamelon double conique ISO 7/1						
 <p>AG = konisch M = conique</p>		50 8321 98	Rotguss verchromt <i>bronze chromé</i> ¾" x ¾"	3		9.84	10.60
		50 8331 98	Rotguss verchromt <i>Bronze chromé</i> ½" x ½"	3		4.83	5.20
		50 8341 98	Rotguss verchromt <i>Bronze chromé</i> ¾" x ¾"	3		6.36	6.85
		50 8421 98	Rotguss verchromt <i>bronze chromé</i> ½" x ¾"	3		5.34	5.75
		50 8441 98	Rotguss verchromt <i>bronze chromé</i> ¾" x ½"	3		5.94	6.40

ROTGUSS BRONZE









	EAN-Nr. <i>no EAN</i>	Artikel Nr. <i>no d'article</i>	Beschreibung <i>description</i>	VPE <i>ce</i>	VE <i>ue</i>	UVP pro Stk. PVC CHF excl.	UVP pro Stk. PVC CHF incl.
--	--------------------------	------------------------------------	------------------------------------	------------------	-----------------	-------------------------------------	-------------------------------------

Reduzierstück konisch ISO 7/1

Réduction conique ISO 7/1



























IG = zylindrisch
AG = konisch
F = cylindrique
M = conique

	50 8800 98	Rotguss verchromt <i>Bronze chromé</i> 3/8" x 1/4"	1		9.94	10.70
	50 8811 98	Rotguss verchromt <i>bronze chromé</i> 1/2" x 3/8"	3		3.44	3.70
	50 8820 98	Rotguss verchromt <i>Bronze chromé</i> 3/4" x 3/8"	1		19.03	20.50
	50 8826 98	Rotguss verchromt <i>bronze chromé</i> 3/4" x 1/2"	3		4.83	5.20

Fittinge verzinkt

Pièces de raccord galvanisées

	EAN-Nr. <i>no EAN</i>	Artikel Nr. <i>no d'article</i>	Beschreibung <i>description</i>	VPE <i>ce</i>	VE <i>ue</i>	UVP pro Stk. PVC CHF excl.	UVP pro Stk. PVC CHF incl.
Rohr	Tube						
		76 1110 94	Stahl verzinkt <i>acier zingué</i> 3/8" ; 500 mm	1		8.96	9.65
		76 1112 94	Stahl verzinkt <i>acier zingué</i> 1/2" ; 500 mm	1		7.85	8.45
		76 1114 94	Stahl verzinkt <i>acier zingué</i> 3/4" ; 500 mm	1		9.66	10.40
		76 1130 94	Stahl verzinkt <i>acier zingué</i> 3/8" ; 1 m	1		14.95	16.10
		76 1132 94	Stahl verzinkt <i>acier zingué</i> 1/2" ; 1 m	1		12.44	13.40
		76 1134 94	Stahl verzinkt <i>acier zingué</i> 3/4" ; 1 m	1		16.25	17.50
		76 1150 94	Stahl verzinkt <i>acier zingué</i> 3/8" ; 1.5 M	1		21.36	23.—
		76 1152 94	Stahl verzinkt <i>acier zingué</i> 1/2" ; 1.5 M	1		16.25	17.50
		76 1154 94	Stahl verzinkt <i>acier zingué</i> 3/4" ; 1.5 M	1		18.57	20.—
		76 1170 94	Stahl verzinkt <i>acier zingué</i> 3/8" ; 2 M	1		27.39	29.50
		76 1172 94	Stahl verzinkt <i>acier zingué</i> 1/2" ; 2 M	1		19.96	21.50
		76 1174 94	Stahl verzinkt <i>acier zingué</i> 3/4" ; 2 M	1		23.21	25.—

Fittinge verzinkt

Pièces de raccord galvanisées

	EAN-Nr. <i>no EAN</i>	Artikel Nr. <i>no d'article</i>	Beschreibung <i>description</i>	VPE <i>ce</i>	VE <i>ue</i>	UVP pro Stk. PVC CHF excl.	UVP pro Stk. PVC CHF incl.
--	--------------------------	------------------------------------	------------------------------------	------------------	-----------------	-------------------------------------	-------------------------------------

Rohrdoppelnippel

Mamelon double tube



7		77 1940 94	verzinkt zingué 3/8" ; 200 mm	10		4.46	4.80
7		77 1945 94	verzinkt zingué 1/2" ; 200 mm	9		4.13	4.45
7		77 1950 94	verzinkt zingué 3/4" ; 200 mm	10		4.97	5.35
7		77 1970 94	verzinkt zingué 3/8" ; 300 mm	10		6.22	6.70
7		77 1960 94	verzinkt zingué 1/2" ; 300 mm	10		4.87	5.25
7		77 1980 94	verzinkt zingué 3/4" ; 300 mm	10		6.78	7.30

Gewinderohr

Tube à filet



7		77 1150 98	verzinkt zingué 3/8" ; 30 mm	10		2.14	2.30
7		77 1155 98	verzinkt zingué 1/2" ; 30 mm	10		2.41	2.60
7		77 1160 98	verzinkt zingué 3/4" ; 30 mm	5		3.30	3.55

Doppelnippel lang

Mamelon double long



7		77 1110 98	verzinkt zingué 3/8" ; 100 mm	10		2.83	3.05
7		77 1115 98	verzinkt zingué 1/2" ; 100 mm	9		3.06	3.30
7		77 1120 98	verzinkt zingué 3/4" ; 100 mm	10		3.30	3.55

Fittinge verzinkt Pièces de raccord galvanisées

	EAN-Nr. no EAN	Artikel Nr. no d'article	Beschreibung description	VPE ce	VE ue	UVP pro Stk. PVC CHF excl.	UVP pro Stk. PVC CHF incl.
--	-------------------	-----------------------------	-----------------------------	-----------	----------	-------------------------------------	-------------------------------------



Doppelnippel

Mamelon double

		77 1610 98	verzinkt zingué 3/8" ; 60 mm	9		2.14	2.30
		77 1615 98	verzinkt zingué 1/2" ; 60 mm	9		2.27	2.45
		77 1620 98	verzinkt zingué 3/4" ; 60 mm	9		2.41	2.60

Aussengewinde Rohr

Tube fileté extérieur

		76 1200 94	Stahl verzinkt acier zingué 1/2" ; 2 M	1		56.64	61.—
------------------------------------------------------------------------------------	-----------------------------------------------------------------------------------	------------	----------------------------------------------	---	-------------------------------------------------------------------------------------	-------	------

Bogen lang

Coude long

		77 1010 98	verzinkt / IG x IG zingué 1/2" ; 90°	9		5.06	5.45
		77 1015 98	verzinkt / IG x IG zingué 3/4" ; 90°	10		7.10	7.65

Bogen lang

Coude long

		77 1030 98	verzinkt / IG x AG zingué 1/2" ; 90°	9		4.78	5.15
		77 1035 98	verzinkt / IG x AG zingué 3/4" ; 90°	10		6.45	6.95

Fittinge verzinkt

Pièces de raccord galvanisées

	EAN-Nr. no EAN	Artikel Nr. no d'article	Beschreibung description	VPE ce	VE ue	UVP pro Stk. PVC CHF excl.	UVP pro Stk. PVC CHF incl.
--	-------------------	-----------------------------	-----------------------------	-----------	----------	-------------------------------------	-------------------------------------

Bogen lang

Coude long



7 611038 688615	77 1060 98	verzinkt / IG x AG zingué / 1/2" ; 45°	9	1	5.62	6.05
7 611038 688622	77 1065 98	verzinkt / IG x AG zingué / 3/4" ; 45°	9	1	6.45	6.95

Winkel

Coude



7 611038 688820	77 1410 98	verzinkt / IG x AG zingué / F x M 3/8"	10	1	4.36	4.70
7 611038 688837	77 1415 98	verzinkt / IG x AG zingué / F x M 1/2"	10	1	3.06	3.30
7 611038 688844	77 1420 98	verzinkt / IG x AG zingué / F x M 3/4"	10	1	4.36	4.70

Winkel

Coude



7 611038 688851	77 1450 98	verzinkt / IG x IG zingué / F x F 3/8"	9	1	3.06	3.30
7 611038 688868	77 1455 98	verzinkt / IG x IG zingué / F x F 1/2"	10	1	2.41	2.60
7 611038 688875	77 1460 98	verzinkt / IG x IG zingué / F x F 3/4"	9	1	2.83	3.05
7 611038 688882	77 1480 98	verzinkt / IG x IG zingué / F x F 1/2" x 3/8"	10	1	4.13	4.45

Fittinge verzinkt Pièces de raccord galvanisées

	EAN-Nr. <i>no EAN</i>	Artikel Nr. <i>no d'article</i>	Beschreibung <i>description</i>	VPE <i>ce</i>	VE <i>ue</i>	UVP pro Stk. PVC CHF excl.	UVP pro Stk. PVC CHF incl.
--	--------------------------	------------------------------------	------------------------------------	------------------	-----------------	-------------------------------------	-------------------------------------

Verschraubung, flachdichtend

Raccord union, PTFE



7 611038 688783	77 1350 98	verzinkt / IG x IG zingué / F x F 1/2"	9	1	4.87	5.25
7 611038 688790	77 1355 98	verzinkt / IG x IG zingué / F x F 3/4"	9	1	8.12	8.75

Verschraubung, flachdichtend

Raccord union, PTFE



7 611038 688806	77 1380 98	verzinkt / IG x AG zingué / F x M 1/2"	9	1	7.43	8.—
7 611038 688813	77 1385 98	verzinkt / IG x AG zingué / F x M 3/4"	9	1	9.94	10.70

T-Stück

Té



7 611038 688899	77 1510 98	verzinkt zingué 3/8"	10	1	4.36	4.70
7 611038 688905	77 1515 98	verzinkt zingué 1/2"	10	1	2.83	3.05
7 611038 688912	77 1520 98	verzinkt zingué 3/4"	9	1	3.62	3.90

Fittinge verzinkt Pièces de raccord galvanisées

	EAN-Nr. no EAN	Artikel Nr. no d'article	Beschreibung description	VPE ce	VE ue	UVP pro Stk. PVC CHF excl.	UVP pro Stk. PVC CHF incl.
--	-------------------	-----------------------------	-----------------------------	-----------	----------	-------------------------------------	-------------------------------------

T-Stück reduziert

Té réduit



7 611038 688929	77 1550 98	verzinkt zingué 1/2" x 3/4" x 1/2"	1		4.87	5.25
7 611038 688936	77 1555 98	verzinkt zingué 3/4" x 1/2" x 3/4"	1		4.69	5.05
7 611038 688943	77 1560 98	verzinkt zingué 3/4" x 1/2" x 1/2"	1		5.34	5.75

Reduziermuffe

Manchon réduit



7 611038 688691	77 1210 98	verzinkt / IG x AG zingué / F x M 1/2" x 3/8"	10		3.99	4.30
7 611038 688707	77 1215 98	verzinkt / IG x AG zingué / F x M 3/4" x 1/2"	9		4.46	4.80
7 611038 688714	77 1220 98	verzinkt / IG x AG zingué / F x M 1" x 3/4"	9		5.62	6.05

Reduktionsmuffe

Manchon réduit



7 611038 688721	77 1250 98	verzinkt / IG x IG zingué / F x F 1/2" x 3/8"	10		3.76	4.05
7 611038 688738	77 1255 98	verzinkt / IG x IG zingué / F x F 3/4" x 1/2"	10		3.99	4.30
7 611038 688745	77 1260 98	verzinkt / IG x IG zingué / F x F 1" x 3/4"	9		3.99	4.30

Fittinge verzinkt

Pièces de raccord galvanisées

	EAN-Nr. no EAN	Artikel Nr. no d'article	Beschreibung description	VPE ce	VE ue	UVP pro Stk. PVC CHF excl.	UVP pro Stk. PVC CHF incl.
--	-------------------	-----------------------------	-----------------------------	-----------	----------	-------------------------------------	-------------------------------------

Reduzierstück

Réduction



7 611038 688752	77 1310 98	verzinkt zingué 1/2" x 3/8"	10	1	2.83	3.05
7 611038 688769	77 1315 98	verzinkt zingué 3/4" x 1/2"	10	1	2.83	3.05
7 611038 688776	77 1320 98	verzinkt zingué 1" x 3/4"	10	1	2.83	3.05

Muffe

Manchon à visser



7 611038 688981	77 1650 98	verzinkt zingué 3/8"	10	1	3.06	3.30
7 611038 688998	77 1655 98	verzinkt zingué 1/2"	10	1	2.83	3.05
7 611038 689001	77 1660 98	verzinkt zingué 3/4"	10	1	3.06	3.30

Stopfen

Bouchon



7 611038 689049	77 1750 98	verzinkt zingué 3/8"	10	1	2.41	2.60
7 611038 689056	77 1755 98	verzinkt zingué 1/2"	10	1	2.41	2.60
7 611038 689063	77 1760 98	verzinkt zingué 3/4"	10	1	2.41	2.60

Fittinge verzinkt Pièces de raccord galvanisées

	EAN-Nr. <i>no EAN</i>	Artikel Nr. <i>no d'article</i>	Beschreibung <i>description</i>	VPE <i>ce</i>	VE <i>ue</i>	UVP pro Stk. PVC CHF excl.	UVP pro Stk. PVC CHF incl.
--	--------------------------	------------------------------------	------------------------------------	------------------	-----------------	-------------------------------------	-------------------------------------

Kappe

Capuchon



7 611038 689018	77 1710 98	verzinkt zingué 3/8"	10	1	2.65	2.85
7 611038 689025	77 1715 98	verzinkt zingué 1/2"	10	1	2.83	3.05
7 611038 689032	77 1720 98	verzinkt zingué 3/4"	10	1	3.06	3.30

Rohrschelle

Colliers



7 611038 689483	13 7610 98	verzinkt galvanisé 3/8", 15 - 18 mm, M8 x 80 mm ; 2 Stk./PCS.	8	2	5.94	6.40
7 611038 689490	13 7615 98	verzinkt galvanisé 1/2", 20 - 25 mm, M8 x 80 mm ; 2 Stk./PCS.	8	2	5.94	6.40
7 611038 689506	13 7620 98	verzinkt galvanisé 3/4", 26 - 30 mm, M8 x 80 mm ; 2 Stk./PCS.	8	2	7.71	8.30

Fittinge verzinkt

Pièces de raccord galvanisées

	EAN-Nr. <i>no EAN</i>	Artikel Nr. <i>no d'article</i>	Beschreibung <i>description</i>	VPE <i>ce</i>	VE <i>ue</i>	UVP pro Stk. PVC CHF excl.	UVP pro Stk. PVC CHF incl.
--	--------------------------	------------------------------------	------------------------------------	------------------	-----------------	-------------------------------------	-------------------------------------

Rohrschelle isoliert

Colliers isolé



7 611038 679200	13 7650 98	verzinkt galvanisé 3/8" ; 2 Stk./PCS.	10	2	11.79	12.70
7 611038 689513	13 7655 98	verzinkt galvanisé 1/2" ; 2 Stk./PCS.	10	2	10.12	10.90
7 611038 689520	13 7660 98	verzinkt galvanisé 3/4" ; 2 Stk./PCS.	10	2	11.23	12.10



Nachfolgemodell
Successeur

Universal-Rohrschelle

Collier universel



7 611038 689070	13 7010 98	verzinkt zingué 3/8" ; 15-18 mm	9	1	5.34	5.75
7 611038 689087	13 7015 98	verzinkt zingué 1/2" ; 20-25 mm	9	1	5.85	6.30
7 611038 689094	13 7020 98	verzinkt zingué 3/4" ; 26-30 mm	9	1	6.45	6.95

Fittinge verzinkt

Pièces de raccord galvanisées

	EAN-Nr. <i>no EAN</i>	Artikel Nr. <i>no d'article</i>	Beschreibung <i>description</i>	VPE <i>ce</i>	VE <i>ue</i>	UVP pro Stk. PVC CHF excl.	UVP pro Stk. PVC CHF incl.
--	--------------------------	------------------------------------	------------------------------------	------------------	-----------------	-------------------------------------	-------------------------------------

Universal-Rohrschelle isoliert

Collier universel isolé



7 611038 679217	13 7045 98	verzinkt zingué 3/8" ; 15-18 mm	9	1	5.62	6.05
7 611038 689100	13 7050 98	verzinkt zingué 1/2" ; 19-22 mm	9	1	8.22	8.85
7 611038 689117	13 7055 98	verzinkt zingué 3/4" ; 27-30 mm	9	1	8.82	9.50

Rohrband

Bride



7 611038 689148	13 7110 98	promatverzinkt galvanisé 3/8" ; 2 Stk./PCS.	9	2	3.25	3.50
7 611038 689155	13 7115 98	promatverzinkt galvanisé 1/2" ; 2 Stk./PCS.	9	2	3.34	3.60
7 611038 689162	13 7120 98	promatverzinkt galvanisé 3/4" ; 2 Stk./PCS.	9	2	3.44	3.70

Klemmverschraubungen

Raccords bicône

	EAN-Nr. <i>no EAN</i>	Artikel Nr. <i>no d'article</i>	Beschreibung <i>description</i>	VPE <i>ce</i>	VE <i>ue</i>	UVP pro Stk. PVC CHF excl.	UVP pro Stk. PVC CHF incl.
--	--------------------------	------------------------------------	------------------------------------	------------------	-----------------	-------------------------------------	-------------------------------------

Klemmverschraubung

Raccord bicône



52 0516 95

Messing verchromt
laiton chromé
3/8" x 10 mm

3



5.66

6.10

Höhe:
Hauteur:
29mm

Klemmverschraubung

Raccord bicône



52 0590 98

verchromt
chromé
3/8" x 10 mm

3



4.22

4.55

Höhe:
Hauteur:
29mm

Klemmverschraubung konisch

Raccord bicône conique



52 0600 98

Messing verchromt
Laiton chromé
3/8" x 10 mm

1



4.04

4.35

Doppel-Klemmverschr. konisch

Raccord bicône conique



52 0550 98

verchromt
chromé
10 mm x 10 mm

3



6.36

6.85

Höhe:
Hauteur:
50mm

Klemmverschraubungen

Raccords bicône

	EAN-Nr. <i>no EAN</i>	Artikel Nr. <i>no d'article</i>	Beschreibung <i>description</i>	VPE <i>ce</i>	VE <i>ue</i>	UVP pro Stk. PVC CHF excl.	UVP pro Stk. PVC CHF incl.
--	--------------------------	------------------------------------	------------------------------------	------------------	-----------------	-------------------------------------	-------------------------------------

Klemmverschraubung Raccord bicône



7 611038 689575	77 2010 98	Messing blank / Klemm. x IG <i>laiton brut / racc. bicône x F</i> 10 mm x 3/8"	10	1	7.99	8.60
7 611038 689582	77 2015 98	Messing blank / Klemm. x IG <i>laiton brut / racc. bicône x F</i> 12 mm x 3/8"	10	1	8.82	9.50
7 611038 689599	77 2020 98	Messing blank / Klemm. x IG <i>laiton brut / racc. bicône x F</i> 12 mm x 1/2"	10	1	9.47	10.20
7 611038 689605	77 2025 98	Messing blank / Klemm. x IG <i>laiton brut / racc. bicône x F</i> 15 mm x 1/2"	10	1	9.94	10.70

Klemmverschraubung Raccord bicône



7 611038 689629	77 2110 98	Messing blank / Klemm. x AG <i>laiton brut / racc. bicône x M</i> 10 mm x 3/8"	10	1	5.62	6.05
7 611038 689636	77 2115 98	Messing blank / Klemm. x AG <i>laiton brut / racc. bicône x M</i> 12 mm x 3/8"	10	1	7.47	8.05
7 611038 689643	77 2120 98	Messing blank / Klemm. x AG <i>laiton brut / racc. bicône x M</i> 12 mm x 1/2"	10	1	7.47	8.05
7 611038 689612	77 2125 98	Messing blank / Klemm. x AG <i>laiton brut / racc. bicône x M</i> 15 mm x 1/2"	10	1	7.47	8.05

Doppel-Klemmverschraubung Raccord bicône double



7 611038 689650	77 2150 98	Messing blank <i>laiton brut</i> 10 x 10 mm	10	1	11.05	11.90
7 611038 689667	77 2155 98	Messing blank <i>laiton brut</i> 12 x 12 mm	10	1	10.77	11.60
7 611038 689674	77 2160 98	Messing blank <i>laiton brut</i> 15 x 15 mm	10	1	11.05	11.90

Klemmverschraubungen

Raccords bicône

	EAN-Nr. <i>no EAN</i>	Artikel Nr. <i>no d'article</i>	Beschreibung <i>description</i>	VPE <i>ce</i>	VE <i>ue</i>	UVP pro Stk. PVC CHF excl.	UVP pro Stk. PVC CHF incl.
--	--------------------------	------------------------------------	------------------------------------	------------------	-----------------	-------------------------------------	-------------------------------------

Winkel

Coude



7 611038 689742	77 2210 98	Messing blank / Klemm. x IG <i>laiton brut / racc. bicône x F</i> 12 mm x 3/8"	10	1	10.12	10.90
7 611038 689759	77 2215 98	Messing blank / Klemm. x IG <i>laiton brut / racc. bicône x F</i> 12 mm x 1/2"	10	1	11.33	12.20
7 611038 689766	77 2220 98	Messing blank / Klemm. x IG <i>laiton brut / racc. bicône x F</i> 15 mm x 1/2"	10	1	13.—	14.—

Winkel

Coude



7 611038 689711	77 2250 98	Messing blank / Klemm. x AG <i>laiton brut / racc. bicône x M</i> 12 mm x 3/8"	10	1	8.82	9.50
7 611038 689728	77 2255 98	Messing blank / Klemm. x AG <i>laiton brut / racc. bicône x M</i> 12 mm x 1/2"	10	1	10.77	11.60
7 611038 689735	77 2260 98	Messing blank / Klemm. x AG <i>laiton brut / racc. bicône x M</i> 15 mm x 1/2"	10	1	11.51	12.40

Winkel

Coude



7 611038 689681	77 2280 98	Messing blank / Klemmversch. <i>laiton brut / raccords bicône</i> 10 x 10 mm	10	1	10.96	11.80
7 611038 689698	77 2285 98	Messing blank / Klemmversch. <i>laiton brut / raccords bicône</i> 12 x 12 mm	10	1	11.51	12.40
7 611038 689704	77 2290 98	Messing blank / Klemmversch. <i>laiton brut / raccords bicône</i> 15 x 15 mm	10	1	15.51	16.70

T-Stück

Té



7 611038 689797	77 2310 98	Messing blank / Klemm. x IG <i>laiton brut / racc. bicône x F</i> 15 x 15 mm x 1/2"	9	1	20.43	22.—
-----------------	------------	-------------------------------------------------------------------------------------------	---	---	-------	------

Klemmverschraubungen

Raccords bicône

	EAN-Nr. <i>no EAN</i>	Artikel Nr. <i>no d'article</i>	Beschreibung <i>description</i>	VPE <i>ce</i>	VE <i>ue</i>	UVP pro Stk. PVC CHF excl.	UVP pro Stk. PVC CHF incl.
--	--------------------------	------------------------------------	------------------------------------	------------------	-----------------	-------------------------------------	-------------------------------------

T-Stück Té



7 611038 689773	77 2350 98	Messing blank / Klemmversch. <i>laiton brut / raccords bicône</i> 12 x 12 x 12 MM	9	1	16.62	17.90
7 611038 689780	77 2355 98	Messing blank / Klemmversch. <i>laiton brut / raccords bicône</i> 15 x 15 x 15 MM	9	1	19.03	20.50

Wandflansch Flanc murale



7 611038 689803	77 2370 98	Messing blank / Klemm. x IG <i>laiton brut / racc. bicône x F</i> 15 mm x 1/2"	9	1	15.51	16.70
-----------------	------------	--------------------------------------------------------------------------------------	---	---	-------	-------

Klemmring Anneau de serrage



7 611038 689902	77 2810 98	Messing blank <i>laiton brut</i> 10 mm ; 2 Stk./PCS.	10	2	3.25	3.50
7 611038 689919	77 2812 98	Messing blank <i>laiton brut</i> 12 mm ; 2 Stk./PCS.	10	2	3.25	3.50
7 611038 689926	77 2815 98	Messing blank <i>laiton brut</i> 15 mm ; 2 Stk./PCS.	10	2	3.25	3.50



Kupferrohr gerade Tube en cuivre droit



7 611038 165512	76 1015 94	verchromt <i>chromé</i> 8 x 10 mm ; 2 M	5		49.21	53.—
7 611038 679316	76 1050 94	blank <i>brut</i> 8 x 10 mm ; 1.6 m	5		28.78	31.—
7 611038 679323	76 1055 94	blank <i>brut</i> 10 x 12 mm ; 1.6 m	5		31.10	33.50
7 611038 679330	76 1060 94	blank <i>brut</i> 13 x 15 mm ; 1.6 m	5		39.—	42.—

Klemmverschraubungen

Raccords bicône

	EAN-Nr. <i>no EAN</i>	Artikel Nr. <i>no d'article</i>	Beschreibung <i>description</i>	VPE <i>ce</i>	VE <i>ue</i>	UVP pro Stk. PVC CHF excl.	UVP pro Stk. PVC CHF incl.
Rohrclip doppelt		Clip pour tube double					
		13 7155 98	Kunststoff <i>plastique</i> 12-15 mm ; 4 Stk./PCS.	3		8.12	8.75

PEX Trinkwasser-Verteilung

PEX distribution d'eau

	EAN-Nr. <i>no EAN</i>	Artikel Nr. <i>no d'article</i>	Beschreibung <i>description</i>	VPE <i>ce</i>	VE <i>ue</i>	UVP pro Stk. PVC CHF excl.	UVP pro Stk. PVC CHF incl.
--	--------------------------	------------------------------------	------------------------------------	------------------	-----------------	-------------------------------------	-------------------------------------

PEX Rohr PEX

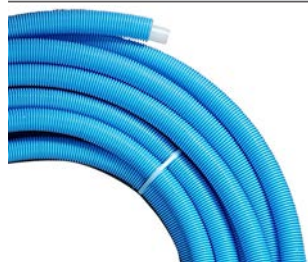

7 611038 175399	77 3401 97	16 x 2.2 mm ; 5 M	1		40.39	43.50
7 611038 175405	77 3402 97	16 x 2.2 mm ; 10 M	1		75.21	81.—
7 611038 182618	77 3403 97	16 x 2.2 mm ; 25 M	1		130.92	141.—

PEX Verteiler 2 Abgänge PEX collecteur 2 voies



7 611038 690175	77 3360 98	Messing blank <i>laiton brut</i> 3/4"	10		29.71	32.—
-----------------	------------	---------------------------------------------	----	--	-------	------

PEX Verteiler 3 Abgänge PEX collecteur 3 voies



7 611038 690199	77 3365 98	Messing blank <i>laiton brut</i> 3/4"	10		31.10	33.50
-----------------	------------	---------------------------------------------	----	--	-------	-------

PEX Verteiler 4 Abgänge PEX collecteur 4 voies



7 611038 690205	77 3370 98	Messing blank <i>laiton brut</i> 3/4"	10		32.96	35.50
-----------------	------------	---------------------------------------------	----	--	-------	-------

PEX Kupplung PEX accoupleur



7 611038 690083	77 3010 98	Messing blank <i>laiton brut</i> 16 x 16 mm	10		11.61	12.50
-----------------	------------	---------------------------------------------------	----	--	-------	-------

PEX Trinkwasser-Verteilung

PEX distribution d'eau

	EAN-Nr. <i>no EAN</i>	Artikel Nr. <i>no d'article</i>	Beschreibung <i>description</i>	VPE <i>ce</i>	VE <i>ue</i>	UVP pro Stk. PVC CHF excl.	UVP pro Stk. PVC CHF incl.
--	--------------------------	------------------------------------	------------------------------------	------------------	-----------------	-------------------------------------	-------------------------------------

PEX Übergangsstück

PEX réduction renforcée



7 611038 690106	77 3030 98	Messing blank / IG <i>laiton brut / F</i> 16 mm x 1/2"	10	1	8.22	8.85
-----------------	------------	--------------------------------------------------------------	----	---	------	------

PEX Übergangsstück

PEX réduction renforcée



7 611038 690090	77 3050 98	Messing blank / AG <i>laiton brut / M</i> 16 mm x 1/2"	10	1	9.15	9.85
-----------------	------------	--------------------------------------------------------------	----	---	------	------

PEX Winkel

PEX coude



7 611038 690137	77 3110 98	Messing blank / IG <i>laiton brut / F</i> 16 mm x 1/2"	10	1	9.84	10.60
7 611038 182557	77 3115 98	Messing blank / AG <i>laiton brut / F</i> 16 mm x 3/4"	9	1	9.94	10.70

PEX Winkel

PEX coude



7 611038 690120	77 3130 98	Messing blank / AG <i>laiton brut / M</i> 16 mm x 1/2"	10	1	10.12	10.90
-----------------	------------	--------------------------------------------------------------	----	---	-------	-------

PEX Trinkwasser-Verteilung

PEX distribution d'eau

	EAN-Nr. <i>no EAN</i>	Artikel Nr. <i>no d'article</i>	Beschreibung <i>description</i>	VPE <i>ce</i>	VE <i>ue</i>	UVP pro Stk. PVC CHF excl.	UVP pro Stk. PVC CHF incl.
--	--------------------------	------------------------------------	------------------------------------	------------------	-----------------	-------------------------------------	-------------------------------------

PEX Winkel

PEX coude



7 611038 690113	77 3150 98	Messing blank <i>laiton brut</i> 16 x 16 mm	10	1	12.91	13.90
-----------------	------------	---------------------------------------------------	----	---	-------	-------

PEX T-Stück

PEX té



7 611038 690144	77 3250 98	Messing blank <i>laiton brut</i> 16 x 16 x 16 mm	9	1	19.03	20.50
-----------------	------------	--------------------------------------------------------	---	---	-------	-------

PEX T-Stück

PEX té



7 611038 690151	77 3210 98	Messing blank / IG <i>laiton brut / F</i> 16 mm x 1/2" x 16 mm	9	1	17.73	19.10
-----------------	------------	----------------------------------------------------------------------	---	---	-------	-------

PEX Wandflansch

Flanc murale



7 611038 690168	77 3310 98	Messing blank / IG <i>laiton brut / F</i> 16 mm x 1/2"	9	1	11.79	12.70
-----------------	------------	--------------------------------------------------------------	---	---	-------	-------

PEX Trinkwasser-Verteilung

PEX distribution d'eau

	EAN-Nr. <i>no EAN</i>	Artikel Nr. <i>no d'article</i>	Beschreibung <i>description</i>	VPE <i>ce</i>	VE <i>ue</i>	UVP pro Stk. PVC CHF excl.	UVP pro Stk. PVC CHF incl.
--	--------------------------	------------------------------------	------------------------------------	------------------	-----------------	-------------------------------------	-------------------------------------

PEX Dosenwinkel

PEX Boîte pour coude



7 611038 690182	77 3320 98	Messing blank / Kunststoff <i>bleu</i> 16 mm x 1/2"	10	1	30.18	32.50
-----------------	------------	-----------------------------------------------------------	----	---	-------	-------

PEX Überwurfmutter

PEX ecrou tournant



7 611038 690212	77 3390 98	Messing blank <i>laiton brut</i> 16 mm	10	1	5.62	6.05
-----------------	------------	----------------------------------------------	----	---	------	------

Verschlusskappe 6-kant

Bouchon femelle 6 pans



7 611038 689865	50 9031 98	Messing blank <i>laiton brut</i> 3/4"	3	1	5.39	5.80
-----------------	------------	---------------------------------------------	---	---	------	------

Bauzapfen

Embout



7 611038 690472	73 1830 98	Kunststoff / blau <i>plastique / bleu</i> 1/2"	9	1	3.25	3.50
7 611038 690489	73 1831 98	Kunststoff / rot <i>plastique / rouge</i> 1/2"	9	1	3.25	3.50

Baustopfen mit Kunststoffgewinde sind nur für eine einmalige Dichtprobe vorgesehen (Bild ähnlich).
Les embouts en plastique sont prévus seulement pour un unique test d'étanchéité (image semblable).

PEX Trinkwasser-Verteilung

PEX distribution d'eau

	EAN-Nr. <i>no EAN</i>	Artikel Nr. <i>no d'article</i>	Beschreibung <i>description</i>	VPE <i>ce</i>	VE <i>ue</i>	UVP pro Stk. PVC CHF excl.	UVP pro Stk. PVC CHF incl.
--	--------------------------	------------------------------------	------------------------------------	------------------	-----------------	-------------------------------------	-------------------------------------

PEX Fix-Ring einfach

PEX Fix-Ring simple



77 3810 98

Kunststoff
plastique
M25 ; 6 Stk./PCS.

10



8.54

9.20

PEX Fix-Ring doppelt

PEX Fix-Ring double



77 3820 98

Kunststoff
plastique
M25 ; 6 Stk./PCS.

10

















9.66

10.40

Dichtungen

Joints

	EAN-Nr. <i>no EAN</i>	Artikel Nr. <i>no d'article</i>	Beschreibung <i>description</i>	VPE <i>ce</i>	VE <i>ue</i>	UVP pro Stk. PVC CHF excl.	UVP pro Stk. PVC CHF incl.
	7 611038 688073	78 6590 98	5 Stück <i>5 pièces</i> 3/8" ; 15 x 8 x 2 mm	5		3.25	3.50
	7 611038 469849	78 6750 98	10 Stück <i>10 pièces</i> 3/8" ; 15 x 10 x 2 mm	5		2.51	2.70
	7 611038 688080	78 6592 98	5 Stück <i>5 pièces</i> 1/2" ; 18 x 10 x 2 mm	5		3.44	3.70
	7 611038 469931	78 6753 96	Tesnit, Beutel à 20 Stück <i>Tesnit / Sachet à 20 pcs.</i> 1/2" ; 18 x 10 x 2 mm	1		4.50	4.85
	7 611038 469825	78 6752 98	10 Stück <i>10 pièces</i> 1/2" ; 18 x 12 x 2 mm	5		3.53	3.80
	7 611038 469832	78 6752 96	Tesnit, Beutel à 20 Stück <i>Tesnit / Sachet à 20 pcs.</i> 1/2" ; 18 x 12 x 2 mm	1		4.92	5.30
	7 611038 678968	78 6330 98	6 Stück <i>6 pièces</i> 3 x 1/2", 18 x 11 x 2 mm ; 3 x 3/4", 24 x 16 x 2 mm	5		3.11	3.35
	7 611038 688097	78 6594 98	5 Stück <i>5 pièces</i> 3/4" ; 24 x 15 x 2 mm	5		3.81	4.10
	7 611038 469948	78 6755 96	Tesnit, Beutel à 20 Stück <i>Tesnit / Sachet à 20 pcs.</i> 3/4" ; 24 x 15 x 2 mm	1		4.36	4.70
	7 611038 469856	78 6754 98	10 Stück <i>10 pièces</i> 3/4" ; 24 x 17 x 2 mm	5		4.50	4.85
	7 611038 469887	78 6754 96	Tesnit, Beutel à 20 Stück <i>Tesnit / Sachet à 20 pcs.</i> 3/4" ; 24 x 17 x 2 mm	1		5.90	6.35
	7 611038 688103	78 6596 98	5 Stück <i>5 pièces</i> 1" ; 30 x 22 x 2 mm	5		4.32	4.65
7 611038 688110	78 6598 98	5 Stück <i>5 pièces</i> 1 1/4" ; 39 x 32 x 2 mm	5		6.45	6.95	

Dichtungen

Joints

	EAN-Nr. <i>no EAN</i>	Artikel Nr. <i>no d'article</i>	Beschreibung <i>description</i>	VPE <i>ce</i>	VE <i>ue</i>	UVP pro Stk. PVC CHF excl.	UVP pro Stk. PVC CHF incl.
--	--------------------------	------------------------------------	------------------------------------	------------------	-----------------	-------------------------------------	-------------------------------------

Holländer-Dichtungen, 10 Stück

Joint p. vis de rappel, 10 PCS



7 611038 469894	78 6758 98	1/2" ; 30 x 21 x 2 mm	5	10	6.31	6.80
7 611038 469900	78 6759 98	3/4" ; 38 x 27 x 2 mm	5	10	6.50	7.—
7 611038 469917	78 6760 98	10 Stück 10 pièces 1" ; 44 x 32 x 2 mm	5	10	7.89	8.50
7 611038 469924	78 6761 98	1 1/4" ; 55 x 42 x 2 mm	5	10	6.87	7.40

Fiberdichtung

Joint en fibre



7 611038 687748	78 6502 98	5 Stück 5 pièces 1/4" ; 17 x 13 x 1 mm	5	5	2.32	2.50
7 611038 687755	78 6504 98	5 Stück 5 pièces 3/8" ; 21 x 17 x 1,5 mm	5	5	2.41	2.60
7 611038 453022	78 6505 98	5 Stück 5 pièces 1/2" ; 18 x 12 x 1.5 mm	5	5	2.51	2.70
7 611038 687762	78 6506 98	5 Stück 5 pièces 3/4" ; 30 x 26,5 x 1,5 mm	5	5	2.51	2.70
7 611038 687779	78 6508 98	5 Stück 5 pièces 1" ; 40 x 33,5 x 2 mm	5	5	2.88	3.10
7 611038 687793	78 6512 98	5 Stück 5 pièces 1 1/4" ; 51 x 42 x 2 mm	5	5	5.06	5.45
7 611038 687786	78 6510 98	5 Stück 5 pièces 1 1/2" ; 58 x 49 x 2 mm	5	5	5.34	5.75

Dichtungen

Joints

	EAN-Nr. <i>no EAN</i>	Artikel Nr. <i>no d'article</i>	Beschreibung <i>description</i>	VPE <i>ce</i>	VE <i>ue</i>	UVP pro Stk. PVC CHF excl.	UVP pro Stk. PVC CHF incl.
--	--------------------------	------------------------------------	------------------------------------	------------------	-----------------	-------------------------------------	-------------------------------------

Gummidichtungen TPE schwarz

Joints en caoutchouc



7 611038 687809	78 6520 98	5 Stück <i>5 pièces</i> 3/8" ; 14 x 9 x 1,5 mm	5		2.41	2.60
7 611038 687816	78 6522 98	5 Stück <i>5 pièces</i> 1/2" ; 18 x 10 x 1 mM	5		2.51	2.70
7 611038 161354	78 1363 98	5 Stück <i>5 pièces</i> 3/4" ; 23.5 x 17.5 x 2 mm	5		2.14	2.30
7 611038 687823	78 6524 98	5 Stück <i>5 pièces</i> 3/4" ; 24 x 16 x 2 mm	5		2.88	3.10
7 611038 687830	78 6526 98	5 Stück <i>5 pièces</i> 1" ; 30 x 23 x 2 mm	5		3.11	3.35
7 611038 687854	78 6530 98	5 Stück <i>5 pièces</i> 1 1/4" ; 39 x 28 x 2 mm	5		3.34	3.60
7 611038 235673	78 6531 96	Beutel à 20 Stück <i>Tesnit / Sachet à 20 pcs.</i> 1 1/4" ; 39 x 28 x 2 mm	1		5.90	6.35
7 611038 687847	78 6528 98	5 Stück <i>5 pièces</i> 1 1/2" ; 45 x 35 x 2 mm	5		3.44	3.70
7 611038 687861	78 6532 98	5 Stück <i>5 pièces</i> 20.8 x 6 x 2 mm ; VARIOPERL	5		2.51	2.70
7 611038 687885	78 6540 98	5 Stück <i>5 pièces</i> M18x1 ; 15 x 10 x 2 mm	5		3.25	3.50
7 611038 687892	78 6542 98	TPE, 5 Stück <i>TPE, 5 pièces</i> M22x1 ; 21 x 15 x 2 mm	5		3.25	3.50
7 611038 687908	78 6544 98	TPE, 5 Stück <i>TPE, 5 pièces</i> M24x1 ; 20.5 x 15 x 3 mm	5		3.25	3.50
7 611038 687915	78 6546 98	5 Stück <i>5 pièces</i> M28x1 ; 25 x 19 x 3 mm	5		3.81	4.10

Gummidichtung anpassbar

Joint en caoutchouc adaptable



7 611038 469740	78 6548 98	Ø 100 mm ; 2 mm	4		4.50	4.85
-----------------	------------	-----------------	---	--	------	------

Dichtungen

Joints

	EAN-Nr. <i>no EAN</i>	Artikel Nr. <i>no d'article</i>	Beschreibung <i>description</i>	VPE <i>ce</i>	VE <i>ue</i>	UVP pro Stk. PVC CHF excl.	UVP pro Stk. PVC CHF incl.
--	--------------------------	------------------------------------	------------------------------------	------------------	-----------------	-------------------------------------	-------------------------------------

Oberteildichtung TPE natur

Joint bonnet TPE naturel



7 611038 688134	78 6602 98	4 Stück 4 pièces 14 x 4 x 4 mm	5		2.04	2.20
7 611038 688141	78 6603 98	4 Stück 4 pièces 15 x 4 x 4.5 mm	5		2.04	2.20
7 611038 688165	78 6605 98	4 Stück 4 pièces 16 x 4 x 4 mm	5		2.18	2.35
7 611038 688172	78 6606 98	4 Stück 4 pièces 17 x 5 x 4 mm	5		2.18	2.35

Oberteildichtung EPDM

Joint bonnet EPDM



7 611038 688158	78 6604 98	schwarz, 4 Stück noire, 4 pièces 16.5 x 5 x 5.5 mm	5		2.69	2.90
7 611038 688189	78 6607 98	schwarz, 4 Stück noire, 4 pièces 18 x 4 x 4.5 mm	5		2.60	2.80
7 611038 688127	78 6601 98	schwarz, 4 Stück noire, 4 pièces 22 x 4 x 4.5 mm	5		2.69	2.90

Oberteildichtung ohne Loch

Joint bonnet sans trou



7 611038 469764	78 1791 98	EPDM, 4 Stück EPDM, 4 pièces 3/8" ; 14 x 4 mm	5		2.88	3.10
7 611038 469788	78 1792 98	NBR, 4 Stück NBR, 4 pièces 1/2" ; 16 x 5 mm	5		3.20	3.45
7 611038 469801	78 1793 98	EPDM, 4 Stück EPDM, 4 pièces 1/2" ; 17 x 4 mm	5		3.20	3.45

Dichtungen

Joints

	EAN-Nr. <i>no EAN</i>	Artikel Nr. <i>no d'article</i>	Beschreibung <i>description</i>	VPE <i>ce</i>	VE <i>ue</i>	UVP pro Stk. PVC CHF excl.	UVP pro Stk. PVC CHF incl.
O-Ringe		Joints torique					
	7 611038 687922	78 6550 98	5 Stück <i>5 pièces</i> 70° SHORE ; 9 x 2 mm	4	5	3.25	3.50
	7 611038 687939	78 6552 98	5 Stück <i>5 pièces</i> 70° SHORE ; 15,08 x 2,62 mm	4	5	3.25	3.50
	7 611038 687946	78 6554 98	5 Stück <i>5 pièces</i> 70° SHORE ; 17,17 x 2,62 mm	5	5	3.25	3.50
	7 611038 687953	78 6556 98	5 Stück <i>5 pièces</i> 70° SHORE ; 21,82 x 3,53 mm	3	5	3.81	4.10
	7 611038 687960	78 6558 98	5 Stück <i>5 pièces</i> 70° SHORE ; 24,99 x 3,53 mm	5	5	3.81	4.10
	7 611038 687977	78 6560 98	5 Stück <i>5 pièces</i> 70° SHORE ; 31,34 x 3,53 mm	5	5	4.32	4.65

O-Ring-Set 70° SHORE		Joints torique 70° SHORE					
	7 611038 181642	78 6565 98	2 Stück pro Dimension <i>2 pièces par dimension</i> 9X2/15,1X2,62/17,17X2,62 ; 21,8X3,5/25X3,53/31.34X3,53 mm	3	1	4.60	4.95

Ø Innen x Schnurstärke
2 Stk. pro Dimension
Ø intérieur x Ø cordon
2 pièces par dimension

9.00 x 2.00 mm
15.10 x 2.62 mm
17.17 x 2.62 mm
21.80 x 3.50 mm
25.00 x 3.53 mm
31.34 x 3.53 mm



Dichtungen

Joints

	EAN-Nr. <i>no EAN</i>	Artikel Nr. <i>no d'article</i>	Beschreibung <i>description</i>	VPE <i>ce</i>	VE <i>ue</i>	UVP pro Stk. PVC CHF excl.	UVP pro Stk. PVC CHF incl.
--	--------------------------	------------------------------------	------------------------------------	------------------	-----------------	-------------------------------------	-------------------------------------

Dichtungssortiment 30-teilig

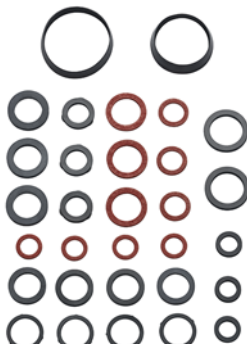
Assortiment de joints 30pièces

		78 6301 98		5		7.47	8.05

- 3 x Fiberdichtung 3/8"
- 10 x 15 x 1.5 mm
- 3 x Fiberdichtung 1/2"
- 12 x 18 x 1.5 mm
- 3 x Fiberdichtung 3/4"
- 17 x 24 x 1.5 mm
- 3 x Gummidichtung 1/2"
- mit Ohren 12 x 19 x 2 mm
- 3 x Gummidichtung 3/4"
- 16 x 24 x 3 mm
- 4 x Gummidichtung M22
- 16 x 20.8 x 1.5 mm
- 4 x Gummidichtung M24
- 15 x 21.3 x 2.8 mm
- 2 x Gummidichtung M28
- 19 x 25.9 x 3.0 mm
- 1 x Keildichtung PVC Ø 32 mm
- 1 x Keildichtung PVC Ø 40 mm
- 3 x joint en fibre 3/8"
- 10 x 15 x 1.5 mm
- 3 x joint en fibre 1/2"
- 12 x 18 x 1.5 mm
- 3 x joint en fibre 3/4"
- 17 x 24 x 1.5 mm
- 3 x joint en caoutchouc 1/2"
- avec oreilles 12 x 19 x 2 mm
- 3 x joint en caoutchouc 3/4"
- 16 x 24 x 3 mm
- 4 x joint en caoutchouc M22
- 16 x 20.8 x 1.5 mm
- 4 x joint en caoutchouc M24
- 15 x 21.3 x 2.8 mm
- 2 x joint en caoutchouc M28
- 19 x 25.9 x 3.0 mm
- 1 x Joints on plastique doux
- PVC Ø 32 mm
- 1 x Joints on plastique doux
- PVC Ø 40 mm

Dichtungen



Joints

	EAN-Nr. <i>no EAN</i>	Artikel Nr. <i>no d'article</i>	Beschreibung <i>description</i>	VPE <i>ce</i>	VE <i>ue</i>	UVP pro Stk. PVC CHF excl.	UVP pro Stk. PVC CHF incl.
--	--------------------------	------------------------------------	------------------------------------	------------------	-----------------	-------------------------------------	-------------------------------------

Dichtungssortiment

Gamme de joints







	78 6547 98	Gummi <i>caoutchouc</i> 4X 3/8", 4X 1/2", 2X 3/4"; 2X M22, 2X M24, 2X M28	3		7.29	7.85
-----------------------------------------------------------------------------------	------------	------------------------------------------------------------------------------------	---	-------------------------------------------------------------------------------------	------	------

Keildichtungen weich

Joints on plastique doux







	78 6566 98	5 Stück <i>5 pièces</i> 1 1/4"; Ø 32 mm	5		3.81	4.10
	78 6568 98	5 Stück <i>5 pièces</i> 1 1/2"; Ø 40 mm	5		3.81	4.10

Hutfilter mit Dichtung

Filtres de rechange avec joint





	78 6570 98	5 Stück <i>5 pièces</i> 1/2", 19 x 14 x 2 mm	5		7.06	7.60
	78 6572 98	5 Stück <i>5 pièces</i> 3/4"	5		7.15	7.70

Siphonverbinder

Connecteur de siphon





	78 6576 98	Ø 40/46 mm	12		3.81	4.10
-------------------------------------------------------------------------------------	------------	------------	----	---------------------------------------------------------------------------------------	------	------

Siphonverbinder

Connecteur de siphon







	78 6578 98	Ø 32/46 mm	12		5.43	5.85
-------------------------------------------------------------------------------------	------------	------------	----	---------------------------------------------------------------------------------------	------	------

Siphonverbinder/Steckdichtung

Joint à enficher





	75 0518 96	no. 152.496.00.1 Ø 40/46 mm	1		4.36	4.70
	75 0519 96	no. 152.495.00.1 Ø 32/46 mm	1		4.36	4.70



GEBERIT



Dichtungen

Joints



	EAN-Nr. <i>no EAN</i>	Artikel Nr. <i>no d'article</i>	Beschreibung <i>description</i>	VPE <i>ce</i>	VE <i>ue</i>	UVP pro Stk. PVC CHF excl.	UVP pro Stk. PVC CHF incl.
--	--------------------------	------------------------------------	------------------------------------	------------------	-----------------	-------------------------------------	-------------------------------------

Dichtungsset		Set de joints					
		78 6310 98	für Siphon Lavabo <i>pour sifons lavabo</i> 1 1/4" ; Ø 32 mm	12		3.57	3.85



Dichtungsset Siphon Spüle		Set joint pour siphon d'évier					
		78 6315 98	1 x Flach-, 3 x Keildichtung <i>1xjoint plat, 3xjoint conique</i> 1 x 1 1/2" ; 3 x 40 mm	3		4.69	5.05

Dichtungssatz		Set de joints					
		75 5052 98	für Siphon Lavabo <i>pour sifons lavabo</i> 5/8" x Ø 32/40 mm ; GEBERIT NO. 240.366.00.1	5		15.60	16.80

GEBERIT

Dichtungssatz		Set de joints					
		75 5053 98	für Sifone <i>pour sifons</i> 5/8" ; 40 mm / 240.367.00.2	5		7.47	8.05

GEBERIT

NEW 0-Ring für Waschtischsiphon		Joint torique p. tuyau siphon					
		75 5055 98	zu Abgangsrohr Direktsiphon <i>dévacuation à passage direct</i> 32 x 2 mm ; 242.562.00.1	5		6.45	6.95

GEBERIT

Dichtungen Joints

	EAN-Nr. <i>no EAN</i>	Artikel Nr. <i>no d'article</i>	Beschreibung <i>description</i>	VPE <i>ce</i>	VE <i>ue</i>	UVP pro Stk. PVC CHF excl.	UVP pro Stk. PVC CHF incl.
--	--------------------------	------------------------------------	------------------------------------	------------------	-----------------	-------------------------------------	-------------------------------------

PE-Schleifring

Bague PE

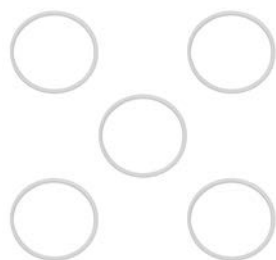

7 611038 688042	78 6582 98	5 Stück 5 pièces 44,5 x 40 x 2 mm	12		5.43	5.85
-----------------	------------	-----------------------------------------	----	--	------	------

Gummidichtung für Tauchrohr

Joints pour tube plongeur

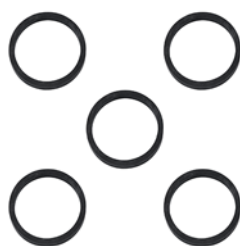

7 611038 687878	78 6534 98	5 Stück 5 pièces 36 x 31 x 4.5 mm	5		5.34	5.75
-----------------	------------	-----------------------------------------	---	--	------	------

WC-Aussenverbinder

Fixation extérieur pour WC



7 611038 688059	78 6586 98	weiss blanc Ø 48 mm ; 38-45 mm	3		6.45	6.95
-----------------	------------	--------------------------------------	---	--	------	------

- für Anschlussstutzen 48mm
- für Spülrohr 38-45mm
- pour raccord de 48mm
- pour tuyau de chasse 38-45mm

WC-Spülrohrverbinder

Manchette pour tube de chasse



7 611038 688066	78 6588 98	hochhängend montage en haut 26-32 mm ROHR ; 48 mm	6		3.25	3.50
-----------------	------------	---------------------------------------------------------	---	--	------	------

- für Anschlussstutzen 48mm
- für Spülrohr 28-32mm
- pour raccord de 48mm
- pour tuyau de chasse 28-32mm



Dichtungen

Joints

	EAN-Nr. <i>no EAN</i>	Artikel Nr. <i>no d'article</i>	Beschreibung <i>description</i>	VPE <i>ce</i>	VE <i>ue</i>	UVP pro Stk. PVC CHF excl.	UVP pro Stk. PVC CHF incl.
--	--------------------------	------------------------------------	------------------------------------	------------------	-----------------	-------------------------------------	-------------------------------------

Heberglockendichtung	Joint de cloche chasse d'eau						
-----------------------------	-------------------------------------	--	--	--	--	--	--





 7 611038 180447	75 0550 98	ab Modell 76 <i>dès modèle 76</i> 63 x 32 x 2 mm ; GEBERIT 816.418.00.1	3	 1	10.12	10.90
------------------------------------------------------------------------------------------------------	------------	----------------------------------------------------------------------------------	---	------------------------------------------------------------------------------------------	-------	-------

GEBERIT

Dichtung zu AP Spülkasten	Joint pour chasse d'eau posé						
----------------------------------	-------------------------------------	--	--	--	--	--	--





 7 611038 180546	75 5051 98	ab 1985 <i>dès 1985</i> 110 x 84 x 14 mm ; GEBERIT 813.812.00.1	5	 1	14.86	16.—
------------------------------------------------------------------------------------------------------	------------	--------------------------------------------------------------------------	---	------------------------------------------------------------------------------------------	-------	------

GEBERIT

Dichtung zu AP Spülkasten	Joint pour chasse d'eau posé						
----------------------------------	-------------------------------------	--	--	--	--	--	--



 7 611038 187651	75 0524 98	70 x 110 x 15 mm	4	 1	7.47	8.05
-------------------------------------------------------------------------------------------------------	------------	------------------	---	-------------------------------------------------------------------------------------------	------	------

Montagematerial

Matériel de montage

	EAN-Nr. no EAN	Artikel Nr. no d'article	Beschreibung description	VPE ce	VE ue	UVP pro Stk. PVC CHF excl.	UVP pro Stk. PVC CHF incl.
--	-------------------	-----------------------------	-----------------------------	-----------	----------	-------------------------------------	-------------------------------------

Dichtungsmasse plastic-fermit

Pâte calfatage plastic-fermit



4 030777 060019	73 3005 94	weiss blanc 250 gR	1		9.66	10.40
-----------------	------------	--------------------------	---	--	------	-------

Dichtungspaste neo-fermit

Pâte d'étanchéité neo-fermit



4 030777 010052	78 0681 94	für metallene Gewinde pour filetage métallique 800 gR	1		28.78	31.—
-----------------	------------	-------------------------------------------------------------	---	--	-------	------

Gewinde-Dichtpaste

Pâte d'étanchéité de filet



4 002545 053738	78 0678 94	90 gR	5		8.03	8.65
7 611038 469962	78 0678 96	90 gR	30		7.89	8.50

Dichtungshanf

Chanvre dans le distributeur



7 611038 162900	78 2210 96	Dispenser 40 g	60		4.50	4.85
-----------------	------------	-------------------	----	--	------	------

Montagematerial



Matériel de montage

	EAN-Nr. <i>no EAN</i>	Artikel Nr. <i>no d'article</i>	Beschreibung <i>description</i>	VPE <i>ce</i>	VE <i>ue</i>	UVP pro Stk. PVC CHF excl.	UVP pro Stk. PVC CHF incl.
--	--------------------------	------------------------------------	------------------------------------	------------------	-----------------	-------------------------------------	-------------------------------------

Gewinde-Dichtpaste + Hanf

Pâte d'étanchéité + chanvre





	78 0679 98	90 gR ; 50 gR	3		14.86	16.—
-----------------------------------------------------------------------------------	------------	---------------	---	-------------------------------------------------------------------------------------	-------	------

Gewindeband PTFE

Ruban pour filetage PTFE







	78 0670 98	12 x 0.075 mm ; 12 M	3		2.79	3.—
-----------------------------------------------------------------------------------	------------	----------------------	---	-------------------------------------------------------------------------------------	------	-----

Sanitär-Silikon

Silicone sanitaire





	78 0660 98	weiss <i>blanc</i> 100 ml	8		9.66	10.40
	78 0662 98	transparent <i>transparente</i> 100 ml	8		9.66	10.40

Befestigungsset für Wand-WC

Jeu de fixation pour toiles





	50 9582 98	verchromt <i>chromé</i> 12 x 140 mm	1		10.96	11.80
-------------------------------------------------------------------------------------	------------	-------------------------------------------	---	---------------------------------------------------------------------------------------	-------	-------

Befestigungsset für Stand-WC

Jeu de fixation pour toiles



	50 9580 98	verchromt <i>chromé</i> 6 x 70 mm	9		6.36	6.85
-------------------------------------------------------------------------------------	------------	-----------------------------------------	---	---------------------------------------------------------------------------------------	------	------

Montagematerial

Matériel de montage

	EAN-Nr. <i>no EAN</i>	Artikel Nr. <i>no d'article</i>	Beschreibung <i>description</i>	VPE <i>ce</i>	VE <i>ue</i>	UVP pro Stk. PVC CHF excl.	UVP pro Stk. PVC CHF incl.
--	--------------------------	------------------------------------	------------------------------------	------------------	-----------------	-------------------------------------	-------------------------------------

Befestigungsset für Lavabo	Jeu de fixation pour lavabo
-----------------------------------	------------------------------------



7 611038 687700	50 9581 98	verchromt <i>chromé</i> 10 x 140 mm	1	1	5.94	6.40
-----------------	------------	-------------------------------------------	---	---	------	------

Standhahn-Mutterschlüssel	Clé de lavabo
----------------------------------	----------------------



7 611038 171421	51 1190 98	10-32 mm	6	1	22.75	24.50
7 611038 177515	51 1195 98	35-60 mm	6	1	28.78	31.—

Reinigung und Service Nettoyage et maintenance

	EAN-Nr. <i>no EAN</i>	Artikel Nr. <i>no d'article</i>	Beschreibung <i>description</i>	VPE <i>ce</i>	VE <i>ue</i>	UVP pro Stk. PVC CHF excl.	UVP pro Stk. PVC CHF incl.
--	--------------------------	------------------------------------	------------------------------------	------------------	-----------------	-------------------------------------	-------------------------------------

Ausguss-Entstopfer

Ventouse à déboucher



35 2506 98

Holzstiel FSC® 100%
manche en bois FSC® 100%
39.5 x 13.5 x 13.5 cm

3



6.31

6.80

Rohrreinigungsspirale

Furet nettoyage



70 8020 96

Metall – mit Spiralkopf
métal
Ø 6 mm ; 3 M

1



14.67

15.80

Rohrreinigungsspirale

Furet



70 8022 96

Metall – mit "Greifkopf"
métal, tête de préhension
Ø 9 mm ; 5 M

1



26.—

28.—

Rohrreinigungsspirale

Furet déboucheur évier



70 8023 96

Metall / blau
métal / bleu
Ø 6 mm ; 4.5 M

1



26.—

28.—

Meisterstamper Ausguss-Entst.

Ventouse à déboucher



70 8070 94

universal
universel
Ø 160 mm, H 520 mm

5









21.36

23.—

Reinigung und Service

Nettoyage et maintenance

	EAN-Nr. <i>no EAN</i>	Artikel Nr. <i>no d'article</i>	Beschreibung <i>description</i>	VPE <i>ce</i>	VE <i>ue</i>	UVP pro Stk. PVC CHF excl.	UVP pro Stk. PVC CHF incl.
Quiki-Set Ablaufreiniger		Quiki-Set net. d'écoulement					
	 7 611038 008857	70 8040 98	½" / M22x1 / M24x1 / M28x1 ; L 300CM x Ø 6 mm	100		38.53	41.50
Saug-/Druckreiniger		Déboucheur					
	 4 004625 719916	70 8071 97	mit schwenkbarer Glocke <i>à ventouse inclinable</i>	6		38.53	41.50

Reinigung und Service

Nettoyage et maintenance

	EAN-Nr. <i>no EAN</i>	Artikel Nr. <i>no d'article</i>	Beschreibung <i>description</i>	VPE <i>ce</i>	VE <i>ue</i>	UVP pro Stk. PVC CHF excl.	UVP pro Stk. PVC CHF incl.
--	--------------------------	------------------------------------	------------------------------------	------------------	-----------------	-------------------------------------	-------------------------------------

Abflussreiniger Rap'id	Déboucheur Rap'id						
-------------------------------	--------------------------	--	--	--	--	--	--

	70 8080 98	Kunststoff Plastique 44 x 1.4 cm ; 2 Stk/pcs	20		5.29	5.70
-----------------------------------------------------------------------------------	-------------------	----------------------------------------------------	----	-------------------------------------------------------------------------------------	-------------	-------------

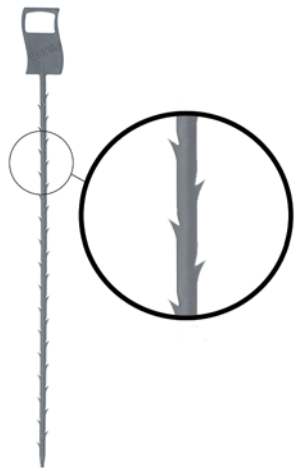
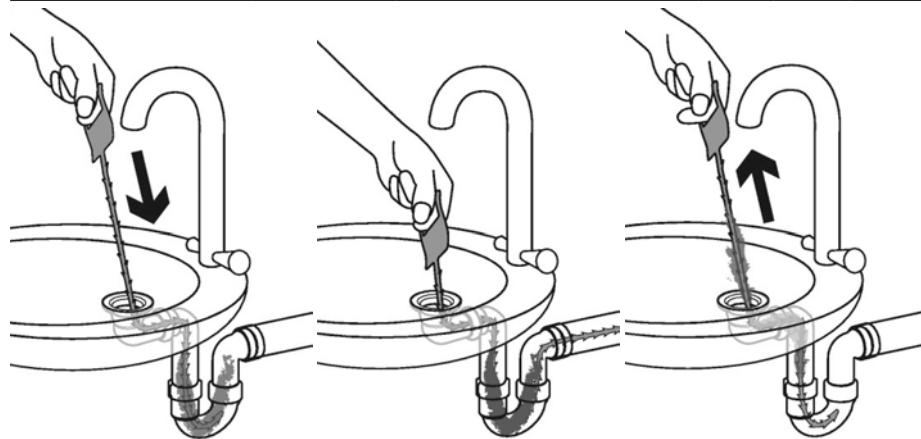

Hergestellt aus Recycling-
Materialien (PCW).
PCW-Anteil > 99 %
Verpackung FSC MIX
*Fabriqué avec matières
recyclées (PCW).*
PCW-pourcentage > 99 %
Emballage FSC MIX

Reinigung und Service Nettoyage et maintenance

	EAN-Nr. <i>no EAN</i>	Artikel Nr. <i>no d'article</i>	Beschreibung <i>description</i>	VPE <i>ce</i>	VE <i>ue</i>	UVP pro Stk. PVC CHF excl.	UVP pro Stk. PVC CHF incl.
--	--------------------------	------------------------------------	------------------------------------	------------------	-----------------	-------------------------------------	-------------------------------------

Universal-Füllventil

Robinet-flotteur universel



58 3500 98

3/8"

25



43.18

46.50

- passt in alle Norm-Spülkästen
- detaillierte Montageanleitung beiliegend
- Durchflussmenge bei 0.5 bar: 4.2 l/min
- s'adapte à toutes chasses d'eau normale
- description de montage détaillée ci-joint
- débit à 0.5 bar: 4.2 l/min

Steckschlüssel

Clé a tube



16 7105 98

zamac
zamac
6 mm ; 2 Stk./PCS.

3



4.83

5.20

Heizkörperschlüssel

Clé pour radiateur



35 5112 98

verzinkt
zingué
5.0 mm ; 2 Stk./PCS.

3



4.22

4.55

Armaturenfett

Graisse pour robinet Glissa



78 0631 98

60G

3



9.66

10.40

Reinigung und Service Nettoyage et maintenance

	EAN-Nr. <i>no EAN</i>	Artikel Nr. <i>no d'article</i>	Beschreibung <i>description</i>	VPE <i>ce</i>	VE <i>ue</i>	UVP pro Stk. PVC CHF excl.	UVP pro Stk. PVC CHF incl.
--	--------------------------	------------------------------------	------------------------------------	------------------	-----------------	-------------------------------------	-------------------------------------

Design-Fühlerelement RAX

thermostatiques de design RAX



5 702420 057323	78 9100 97	Chrom <i>chromé</i> R 1/2 AG ; R 1/2	50		66.85	72.—
5 702420 110523	78 9101 97	Weiss <i>Blanc</i> M30X1.5	1		54.78	59.—
5 702420 057309	78 9102 97	Weiss <i>Blanc</i> R 1/2 AG ; R 1/2	1		54.78	59.—
5 702420 065496	78 9103 97	schwarz <i>noir</i> R 1/2	50		62.21	67.—

Heizkörperthermostat Eco

Thermostat radiateur Eco





5 702425 245329	78 9108 97	weiss <i>blanc</i>	12		65.—	70.—
-----------------	------------	-----------------------	----	--	------	------



- Bis 30% Energieeinsparung
- In-home Steuerung Ihrer Heizkörperthermostate
- Einfache und schnelle Installation
- Niedriger Geräuschpegel < 30dB
- Manuelle Einstellung mit Drehradlösung
- *Programmez vos thermostats via Bluetooth*
- *Installation rapide et simple*
- *Niveau de bruit très faible < 30dB*
- *Possibilité de contrôler le thermostat manuellement en tournant la molette*
- Einfache Steuerung jedes einzelnen Heizkörpers über App auf dem Smartphone mit Bluetooth-Technologie
- *Des économies d'énergies allant jusqu'à 30 %*
- *Contrôle de la température facilité depuis votre domicile*
- *programmez le pour vous simplifier le quotidien*
- *Un contrôle facilité et individuel de chaque radiateur via app smartphone fonctionnant avec la technologie Bluetooth*

Reinigung und Service Nettoyage et maintenance

	EAN-Nr. <i>no EAN</i>	Artikel Nr. <i>no d'article</i>	Beschreibung <i>description</i>	VPE <i>ce</i>	VE <i>ue</i>	UVP pro Stk. PVC CHF excl.	UVP pro Stk. PVC CHF incl.
Starter Pack Ally		Pack de démarrage Ally					
	 5 702424 056551	78 9109 97	weiss blanc RA, RAV, RAVL, M30 x 1.5 ; 5 – 35 °C	12		187.56	202.—



- Einfache Installation und Bedienung mit App
- Steuerung mit Sprachassistent Amazon Alexa, Google Assistant
- Public API Schnittstelle
- Cloudserver mit sicherer AES Verschlüsselung für Datensicherheit
- Zigbee 3.0-zertifiziert
- Passend für alle gängigen Heizkörperventile
- *Installation et utilisation faciles grâce au contrôle des applications*
- *Contrôle avec l'assistant linguistique Amazon Alexa ou Google Assistant*
- *Interface Public API*
- *Serveur Cloud avec cryptage AES pour plus de sécurité des données*
- *Certifié ZigBee 3.0*
- *Convient à tous les corps de vannes courants*
- Batterielebensdauer >2 Jahre
- Stellgeräusch <30dBA
- Bis 30% Energieeinsparungen
- Für Heizkörper und/oder Fussbodenheizung mit bis 32 Ally™ Thermostaten
- Erfüllt EU-Richtlinie EPBD zur Gesamtenergieeffizienz von Gebäuden
- *Durée de vie de la Gesamtenergieeff-batterie >2 ans*
- *Niveau de bruit du thermostat <30dBA*
- *Jusqu'à 30 % d'économies d'énergie*
- *Pour les radiateurs et/ou le chauffage au sol avec jusqu'à 32 Ally™ thermostats*
- *Conforme à la directive européenne sur la performance énergétique des bâtiments*

Reinigung und Service Nettoyage et maintenance

	EAN-Nr. <i>no EAN</i>	Artikel Nr. <i>no d'article</i>	Beschreibung <i>description</i>	VPE <i>ce</i>	VE <i>ue</i>	UVP pro Stk. PVC CHF excl.	UVP pro Stk. PVC CHF incl.
--	--------------------------	------------------------------------	------------------------------------	------------------	-----------------	-------------------------------------	-------------------------------------

Heizkörperthermostat Ally

Thermostat de radiateur Ally



78 9110 97

weiss
blanc
RA, RAV, RAVL, M30 x 1.5 ;
5 – 35 °C

24



92.85

100.—































- Elektronischer Heizkörperthermostat
- Radiator Heizkörperthermostat
- Batteriebetrieb
- Kompakt und einfach zu bedienen
- *Tête thermostatique est un robinet connecté destiné à une utilisation résidentielle.*
- *Le thermostat de radiateur est alimenté par des piles.*
- *Compact et facile à utiliser grâce à un volant manuel et un bouton unique.*

- Danfoss Ally™ Heizkörperthermostat ist ein Zigbee 3.0-zertifiziertes Produkt, mit Danfoss Ally Gateway™ und mit Systemen von Drittanbietern, die das Zigbee-Protokoll verwenden, kompatibel
- *Le thermostat est un produit certifié Zigbee 3.0, compatible avec Danfoss Ally Gateway™ et avec systèmes tiers utilisant le protocole Zigbee.*

FLEXO® Panzerschläuche

FLEXO® Tuyaux renforcés

	EAN-Nr. <i>no EAN</i>	Artikel Nr. <i>no d'article</i>	Beschreibung <i>description</i>	VPE <i>ce</i>	VE <i>ue</i>	UVP pro Stk. PVC CHF excl.	UVP pro Stk. PVC CHF incl.
Anschlusschlauch DN8		Tuyau d'alimentation DN8					
	 7 611038 126995	38 8310 159	IG x IG F x F 3/8" x 3/8" ; 15 cm	3		13.93	15.—
	 7 611038 127008	38 8310 209	IG x IG F x F 3/8" x 3/8" ; 20 cm	3		14.30	15.40
	 7 611038 127015	38 8310 309	IG x IG F x F 3/8" x 3/8" ; 30 cm	3		16.62	17.90
	 7 611038 127022	38 8310 409	IG x IG F x F 3/8" x 3/8" ; 40 cm	3		19.96	21.50
	 7 611038 127039	38 8310 509	IG x IG F x F 3/8" x 3/8" ; 50 cm	3		21.36	23.—
	 7 611038 128494	38 8311 008	IG x IG F x F 3/8" x 3/8" ; DN8 / 100 cm	3		20.89	22.50
	 7 611038 127114	38 8320 159	IG x IG F x F 1/2" x 1/2" ; 15 cm	3		13.93	15.—
	 7 611038 127121	38 8320 209	IG x IG F x F 1/2" x 1/2" ; 20 cm	3		16.62	17.90
	 7 611038 127138	38 8320 309	IG x IG F x F 1/2" x 1/2" ; 30 cm	3		18.29	19.70
	 7 611038 127145	38 8320 409	IG x IG F x F 1/2" x 1/2" ; 40 cm	3		19.96	21.50
	 7 611038 127152	38 8320 509	IG x IG F x F 1/2" x 1/2" ; 50 cm	3		21.82	23.50
	 7 611038 128593	38 8321 008	IG x IG F x F 1/2" x 1/2" ; DN8 / 100 cm	3		20.89	22.50
	 7 611038 161798	38 8842 008	IG x IG F x F 3/4" x 3/4" ; DN8 / 200 cm	3		26.93	29.—
	 7 611038 161804	38 8842 508	IG x IG F x F 3/4" x 3/4" ; DN8 / 250 cm	3		30.18	32.50

















FLEXO® Panzerschläuche

FLEXO® Tuyeaux renforcés

	EAN-Nr. <i>no EAN</i>	Artikel Nr. <i>no d'article</i>	Beschreibung <i>description</i>	VPE <i>ce</i>	VE <i>ue</i>	UVP pro Stk. PVC CHF excl.	UVP pro Stk. PVC CHF incl.
--	--------------------------	------------------------------------	------------------------------------	------------------	-----------------	-------------------------------------	-------------------------------------

Anschlusschlauch DN8





Tuyau d'alimentation DN8

		38 8330 209	IG x IG F x F 3/8" x 1/2" ; 20 cm	3		14.30	15.40
		38 8330 309	IG x IG F x F 3/8" x 1/2" ; 30 cm	3		16.62	17.90
		38 8330 409	IG x IG F x F 3/8" x 1/2" ; 40 cm	3		19.96	21.50
		38 8330 509	IG x IG F x F 3/8" x 1/2" ; 50 cm	3		21.36	23.—
		38 8331 00	IG x IG F x F 3/8" x 1/2" ; 100 cm	5		19.03	20.50
		38 8529 98	IG x IG F x F 1/2" x 3/4" ; 30 cm	200		12.44	13.40
		38 8530 98	IG x IG F x F 1/2" x 3/4" ; 50 cm	150		15.41	16.60



Panzerschlauch DN8

























Tuyau renforcé DN8

		38 8521 98	IG x IG gebogen F x F coudé 3/8" x 3/8" ; 20 cm	5		9.38	10.10
		38 8391 508	IG x IG gebogen F x F coudé 3/4" x 3/4" ; DN8 / 150 cm	3		39.—	42.—



FLEXO® Panzerschläuche

FLEXO® Tuyeaux renforcés

	EAN-Nr. <i>no EAN</i>	Artikel Nr. <i>no d'article</i>	Beschreibung <i>description</i>	VPE <i>ce</i>	VE <i>ue</i>	UVP pro Stk. PVC CHF excl.	UVP pro Stk. PVC CHF incl.
Anschlusschlauch DN8		Tuyau d'alimentation DN8					
	 7 611038 126896	38 8340 129	IG x Quetschverschraubung <i>F x Raccord bicône</i> 3/8" x 10 mm ; 12 cm	3		13.93	15.—
	 7 611038 126902	38 8340 209	IG x Quetschverschraubung <i>F x Raccord bicône</i> 3/8" x 10 mm ; 20 cm	3		15.04	16.20
	 7 611038 168124	38 8340 259	IG x Quetschverschraubung <i>F x Raccord bicône</i> 3/8" x 10 mm ; 25 cm	30		15.41	16.60
	 7 611038 126919	38 8340 309	IG x Quetschverschraubung <i>F x Raccord bicône</i> 3/8" x 10 mm ; 30 cm	3		16.62	17.90
	 7 611038 167950	38 8340 359	IG x Quetschverschraubung <i>F x Raccord bicône</i> 3/8" x 10 mm ; 35 cm	30		15.04	16.20
	 7 611038 126926	38 8340 409	IG x Quetschverschraubung <i>F x Raccord bicône</i> 3/8" x 10 mm ; 40 cm	3		15.41	16.60
	 7 611038 126933	38 8340 509	IG x Quetschverschraubung <i>F x Raccord bicône</i> 3/8" x 10 mm ; 50 cm	3		20.89	22.50
	 7 611038 161743	38 8341 008	IG x Quetschverschraubung <i>F x Raccord bicône</i> 3/8" x 10 mm ; DN8 / 100 cm	3		30.18	32.50
	 7 611038 126957	38 8350 209	IG x Quetschverschraubung <i>F x Raccord bicône</i> 1/2" x 10 mm ; 20 cm	3		14.30	15.40
	 7 611038 126964	38 8350 309	IG x Quetschverschraubung <i>F x Raccord bicône</i> 1/2" x 10 mm ; 30 cm	3		17.18	18.50
	 7 611038 126971	38 8350 409	IG x Quetschverschraubung <i>F x Raccord bicône</i> 1/2" x 10 mm ; 40 cm	3		19.96	21.50
	 7 611038 126988	38 8350 509	IG x Quetschverschraubung <i>F x Raccord bicône</i> 1/2" x 10 mm ; 50 cm	3		22.75	24.50







FLEXO® Panzerschläuche

FLEXO® Tuyeaux renforcés

	EAN-Nr. <i>no EAN</i>	Artikel Nr. <i>no d'article</i>	Beschreibung <i>description</i>	VPE <i>ce</i>	VE <i>ue</i>	UVP pro Stk. PVC CHF excl.	UVP pro Stk. PVC CHF incl.
--	--------------------------	------------------------------------	------------------------------------	------------------	-----------------	-------------------------------------	-------------------------------------

Panzerschlauch DN8





Tuyau renforcé DN8

	 7 611038 215514	38 8501 98	Quetschversch. x Rohrstopfen <i>raccord bicône x tube</i> 8MM x 8MM ; 30 cm	5		11.42	12.30
	 7 611038 215545	38 8504 98	Quetschversch. x Rohrstopfen <i>raccord bicône x tube</i> 10 mm x 10 mm ; 30 cm	200		11.42	12.30



Anschlusschlauch DN 8









Tuyau renforcé DN 8

	 7 611038 161729	38 8480 309	IG x AG <i>F x M</i> 3/8" x 3/8" ; 30 cm	3		15.60	16.80
	 7 611038 161712	38 8480 509	IG x AG <i>F x M</i> 3/8" x 3/8" ; 50 cm	3		18.57	20.—



Anschlusschlauch DN 8

Tuyau renforcé DN 8

	 7 611038 168094	38 8620 359	IG x AG kurz <i>F x M court</i> 3/8" x M8x1 ; 35 cm	10		15.41	16.60
	 7 611038 179229	38 8620 509	IG x AG kurz <i>F x M court</i> 3/8" x M8x1 ; 50 cm	3		16.53	17.80
	 7 611038 168087	38 8630 359	IG x AG kurz <i>F x M court</i> 3/8" x M10x1 ; 35 cm	3		15.41	16.60
	 7 611038 167967	38 8630 509	IG x AG kurz <i>F x M court</i> 3/8" x M10x1 ; 50 cm	3		16.53	17.80













FLEXO® Panzerschläuche

FLEXO® Tuyeaux renforcés

	EAN-Nr. no EAN	Artikel Nr. no d'article	Beschreibung description	VPE ce	VE ue	UVP pro Stk. PVC CHF excl.	UVP pro Stk. PVC CHF incl.
--	-------------------	-----------------------------	-----------------------------	-----------	----------	-------------------------------------	-------------------------------------

Anschlusschlauch DN10







Tuyau d'alimentation DN10

		38 8410 509	IG x IG F x F 3/4" x 3/4" ; 50 cm	3		19.96	21.50
		38 8410 759	IG x IG F x F 3/4" x 3/4" ; 75 cm	3		17.55	18.90
		38 8411 008	IG x IG F x F 3/4" x 3/4" ; 100 cm	3		22.28	24.—
		38 8411 508	IG x IG F x F 3/4" x 3/4" ; DN10 / 150 cm	3		25.07	27.—
		38 8412 008	IG x IG F x F 3/4" x 3/4" ; DN10 / 200 cm	3		26.46	28.50



Anschlusschlauch DN 10





Tuyau renforcé DN 10

		38 8420 809	IG x IG gebogen F x F coudé 3/4" x 3/4" ; 80 cm	3		23.21	25.—
		38 8421 508	IG x IG gebogen F x F coudé 3/4" x 3/4" ; DN10 / 150 cm	3		25.53	27.50
		38 8422 008	IG x IG gebogen F x F coudé 3/4" x 3/4" ; 200 cm	3		27.86	30.—



Anschlusschlauch DN13

Tuyau d'alimentation DN13

		38 8452 508	IG x IG F x F 3/4" x 3/4" ; DN13 / 250 cm	3		29.25	31.50
		38 8453 008	IG x IG F x F 3/4" x 3/4" ; DN13 / 300 cm	3		38.53	41.50



FLEXO® Panzerschläuche

FLEXO® Tuyeaux renforcés

	EAN-Nr. <i>no EAN</i>	Artikel Nr. <i>no d'article</i>	Beschreibung <i>description</i>	VPE <i>ce</i>	VE <i>ue</i>	UVP pro Stk. PVC CHF excl.	UVP pro Stk. PVC CHF incl.
--	--------------------------	------------------------------------	------------------------------------	------------------	-----------------	-------------------------------------	-------------------------------------

Anschlusschlauch DN13

Tuyau renforcé DN13



7 611038 167943	38 8470 609	IG x IG gebogen <i>F x F coudé</i> 1/2" x 1/2" ; 60 cm	3		22.75	24.50
7 611038 128753	38 8461 008	IG x IG gebogen <i>F x F coudé</i> 3/4" x 3/4" ; DN13 / 100 cm	3		25.53	27.50
7 611038 128760	38 8462 008	IG x IG gebogen <i>F x F coudé</i> 3/4" x 3/4" ; DN13 / 200 cm	3		29.25	31.50
7 611038 128685	38 8463 008	IG x IG gebogen <i>F x F coudé</i> 3/4" x 3/4" ; DN13 / 300 cm	3		38.53	41.50









FLEXO® Panzerschläuche

FLEXO® Tuyeaux renforcés

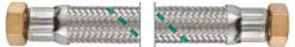
	EAN-Nr. <i>no EAN</i>	Artikel Nr. <i>no d'article</i>	Beschreibung <i>description</i>	VPE <i>ce</i>	VE <i>ue</i>	UVP pro Stk. PVC CHF excl.	UVP pro Stk. PVC CHF incl.
--	--------------------------	------------------------------------	------------------------------------	------------------	-----------------	-------------------------------------	-------------------------------------







Panzerschlauch DN20

Tuyau renforcé DN20

		38 8553 98	IG x IG F x F ¾" x ¾" ; 50 cm	1		32.03	34.50
		38 8554 98	IG x IG F x F ¾" x ¾" ; 70 cm	1		42.71	46.—
		38 8555 98	IG x IG F x F ¾" x ¾" ; 100 cm	3		47.35	51.—





Panzerschlauch DN25

Tuyau renforcé DN25

		38 8556 98	IG x IG F x F 1" x 1" ; 50 cm	3		47.35	51.—
		38 8557 98	IG x IG F x F 1" x 1" ; 70 cm	3		59.42	64.—
		38 8558 98	IG x IG F x F 1" x 1" ; 100 cm	1		68.71	74.—

Panzerschlauch DN32

Tuyau renforcé DN 32







		38 8559 98	IG x IG F x F 1¼" x 1¼" ; 70 cm	1		78.92	85.—
		38 8560 98	IG x IG F x F 1¼" x 1¼" ; 100 cm	1		95.64	103.—

TECHLINE NT

	EAN-Nr. <i>no EAN</i>	Artikel Nr. <i>no d'article</i>	Beschreibung <i>description</i>	VPE <i>ce</i>	VE <i>ue</i>	UVP pro Stk. PVC CHF excl.	UVP pro Stk. PVC CHF incl.
--	--------------------------	------------------------------------	------------------------------------	------------------	-----------------	-------------------------------------	-------------------------------------

Panzerschlauch DN 25

Tuyau renforcé DN 25

	 7 611038 179212	32 9071 119	IG x IG F x F 1" x 1" ; 50 cm	10		34.82	37.50
	 7 611038 168216	32 9072 119	IG x IG F x F 1" x 1" ; 70 cm	1		39.—	42.—
	 7 611038 168209	32 9073 119	IG x IG F x F 1" x 1" ; 100 cm	1		45.03	48.50

Panzerschlauch DN 32

Tuyau renforcé DN 32

	 7 611038 179205	32 9272 119	IG x IG F x F 1 1/4" x 1 1/4" ; 70 cm	1		58.50	63.—
-----------------------------------------------------------------------------------	------------------------------------------------------------------------------------------------------	-------------	---------------------------------------------	---	-------------------------------------------------------------------------------------	-------	------

Prospekte u. Verkaufshilfen *Prospectus et aides de vente*

	EAN-Nr. <i>no EAN</i>	Artikel Nr. <i>no d'article</i>	Beschreibung <i>description</i>	VPE <i>ce</i>	VE <i>ue</i>	UVP pro Stk. PVC CHF excl.	UVP pro Stk. PVC CHF incl.
--	--------------------------	------------------------------------	------------------------------------	------------------	-----------------	-------------------------------------	-------------------------------------

Gewindelehre mit Kleber

Calibre filetage étiquette



98 9125 56

maxi 11 Dimensionen
maxi / 11 dimensions
32 x 10 x 20 cm

1



Preis auf Anfrage.
Bei Interesse kontaktieren Sie
unseren Aussendienst.
Prix sur demande.
En cas d'intérêt, veuillez
contacter nos représentants.

Flyer "Heizkosten sparen!"

Dépliant "coûts de chauffage"



98 9121 20

deutsch
allemand
D ; A6

1



98 9121 21

französisch
français
F ; A6

1



98 9121 22

italienisch
italien
I ; A6

1



Preis auf Anfrage.
Bei Interesse kontaktieren Sie
unseren Aussendienst.
Prix sur demande.
En cas d'intérêt, veuillez
contacter nos représentants.

Prospekte u. Verkaufshilfen *Prospectus et aides de vente*

	EAN-Nr. <i>no EAN</i>	Artikel Nr. <i>no d'article</i>	Beschreibung <i>description</i>	VPE <i>ce</i>	VE <i>ue</i>	UVP pro Stk. PVC CHF excl.	UVP pro Stk. PVC CHF incl.
--	--------------------------	------------------------------------	------------------------------------	------------------	-----------------	-------------------------------------	-------------------------------------

Leporello Trinkwasserinst. PEX

Brochure installation eau PE-X



7 611038 185176	98 0058 90	Version Deutsch <i>Version allemand</i> 312 x 210 mm	1			
7 611038 185251	98 0058 91	Version Französisch <i>Version français</i> 312 x 210 mm	1			
7 611038 118068	98 0058 92	Version Italienisch <i>Version italien</i> 312 x 210 mm	1			

Preis auf Anfrage.

Bei Interesse kontaktieren Sie
unseren Aussendienst.

Prix sur demande.

*En cas d'intérêt, veuillez
contacter nos représentants.*

DIAQUA AG
Pfeffingerstrasse 21
4153 Reinach
Schweiz

Tel. +41 (0)61 716 75 11
Fax +41 (0)61 716 74 59
info@diaqua.ch
www.diaqua.ch

