

diaqua®

Sortiment 2025
Assortiment 2025



Sortiment 2025

Ein schöner Tag beginnt in einem schönen Bad.

Assortiment 2025

*Une belle journée
commence dans un beau bain.*



**Nachhaltige Inspiration
jetzt verfügbar!**

*L'inspiration durable est
désormais disponible !*



Inhaltsverzeichnis

Sommaire



| | | |
|----------|--|-----|
| 1 | Badezimmertextilien und Zubehör | |
| | <i>Textiles de salle de bains et accessoires</i> | 1.1 |



| | | |
|----------|----------------------------|-----|
| 2 | Stellaccessoires | |
| | <i>Accessoires à poser</i> | 2.1 |



| | | |
|----------|---------------------|-----|
| 5 | WC-Sitze | |
| | <i>Sièges de WC</i> | 5.1 |



| | | |
|----------|---|-----|
| 6 | Brausen, Brauseschläuche und Zubehör | |
| | <i>Poignées, flexibles de douche et accessoires</i> | 6.1 |



3 Wandserien und Garnituren
Series murales et garnitures

3.1



4 Zubehör für Bad, Küche und Haushalt
Accessoires pour le bain, la cuisine et ménager 4.1



7 Küche und Waschküche
Cuisine et buanderie

7.1

Marke diaqua®

Marke diaqua®

Komfort und Schönheit im Badezimmer steht für uns an erster Stelle. Seit 2011 verwandeln wir von diaqua® jedes langweilige Badezimmer mit Hilfe von form-schönen Stellaccessoires und spannenden WC-Sitzen in eine Wohlfühloase.

Zusätzlich begeistern wir mit einem vielseitigen Textilsortiment mit attraktiven Duschvorhängen und passenden Badteppichen sowie rutschfeste Wannen- und Duscheinlagen, welche für die Trittsicherheit im Badezimmer sorgen. Eine Vielzahl an praktischen Organizern und Wäschekörben haben die Erfolgsstory unserer innovativen Marke diaqua® fortgesetzt und uns zum Komplettanbieter für Badzimmerdekoration gemacht.

«Mit unseren vielseitigen Produktideen in den neuesten Designs und Material-Trends lässt sich jedes Bad individuell gestalten und wird zum neuen Lieblingszimmer.»

Le confort et la beauté de la salle de bains sont notre priorité. Depuis 2011, notre marque diaqua® transforme toute salle de bains ennuyeuse en une oasis de bien-être à l'aide d'accessoires esthétiques et de sièges de WC captivants.

De plus, nous proposons un assortiment textile varié avec des rideaux de douche attrayants et des tapis de bain assortis, ainsi que des tapis de baignoire et de douche antidérapants qui assurent l'antidérapance dans la salle de bains. Une multitude d'organiseurs et de paniers à linge pratiques ont poursuivi la success story de notre marque innovante diaqua® et ont fait de nous un fournisseur complet de décoration de salle de bains.

«Grâce à nos idées de produits polyvalents dans les dernières tendances en matière de design et de matériaux, chaque salle de bains peut être personnalisée et devenir votre nouvelle pièce préférée.»



Markenversprechen diaqua®

Promesse de la marque diaqua®

- Unsere Badezimmerprodukte bestehen alle aus erlesenen und angenehmen Materialien und überzeugen durch hochwertige Verarbeitung.
- Beim täglichen Gebrauch setzen wir auf eine verlässliche Funktionalität, eine einfache Installation und auf leichtes Handling.
- Wir sind stets auf der Suche nach neuartigen, smarten Produkteigenschaften sowie nachhaltigen und modernen Materialien. Neue Trends greifen wir schnell auf und entwickeln uns dadurch stetig weiter.
- Nos produits pour la salle de bains sont tous fabriqués à partir de matériaux agréables et convainquent par leur finition de qualité.
- Pour l'utilisation quotidienne, nous misons sur une fonctionnalité fiable, une installation simple et une manipulation aisée.
- Nous sommes toujours à la recherche de caractéristiques de produits innovantes et intelligentes ainsi que de matériaux durables et modernes. Nous saisissons rapidement les nouvelles tendances et nous nous développons ainsi en permanence.

Verantwortung und Nachhaltigkeit

Responsabilité et durabilité

Mitgliedschaft bei amfori

Mit unserer Mitgliedschaft bei amfori engagieren wir uns für verbesserte Arbeitsbedingungen in der globalen Lieferkette. Damit verhindern wir Kinderarbeit und sorgen für die Einhaltung gesetzlicher Mindestlöhne.

Adhésion à amfori

En devenant membre d'amfori, nous nous engageons à améliorer les conditions de travail dans la chaîne d'approvisionnement mondiale. Nous empêchons ainsi le travail des enfants et veillons au respect des salaires minimums légaux.



FSC® Zertifizierung

Das FSC®-Label auf unseren Holzprodukten ist ein eindeutiger Indikator für Material aus verantwortungsvoller Waldwirtschaft. Ausserdem sind wir bemüht, unsere Papierverpackungen von FSC®-zertifizierten Verpackungslieferanten zu beziehen.

Certification FSC®

Le label FSC® apposé sur nos produits en bois est un indicateur clair de matériaux issus de forêts. En outre, nous nous efforçons d'acheter nos emballages papier auprès de fournisseurs d'emballages certifiés FSC®.



Verantwortungsvoller Umgang mit der wertvollen Ressource Trinkwasser

Ein umweltbewusster Umgang mit der Ressource Trinkwasser ist uns sehr wichtig, daher sind viele unserer Brauseschläuche und Duschbrausen mit einem smarten Wasserregler ausgestattet, der einen verantwortungsvollen Wasserverbrauch gewährleistet.

Une utilisation responsable de la précieuse ressource qu'est l'eau potable

Une utilisation écologique de la ressource eau potable est très importante pour nous, c'est pourquoi beaucoup de nos flexibles de douche et douches sont équipés d'un régulateur d'eau intelligent qui garantit une consommation d'eau responsable.



BADEZIMMERTEXTILIEN

Mit unseren Badezimmertextilien lässt sich in jedem langweiligen Bad ein wohnliches Ambiente schaffen. Unsere Kollektion bietet eine grosse Auswahl an hochwertigen Badezimmertextilien. In dieser Vielfalt finden sich stets Farben und Motive, die in die individuelle Badezimmereinrichtung passen.

TEXTILES DE SALLE DE BAINS

Nos textiles de salle de bains permettent de créer une ambiance chaleureuse dans n'importe quelle salle de bains ennuyeuse. Notre collection offre un grand choix de textiles de salle de bains de qualité. Dans cette diversité, on trouve toujours des couleurs et des motifs qui s'adaptent à l'aménagement individuel de la salle de bains.

ACCESSOIRES

Unsere Stellaccessoires sind in diversen Materialausführungen erhältlich. Mit glänzender oder matter Keramik, farbigem Glas, Holz, Metall oder bruchsicherem Kunststoff setzen wir schöne Farbakzente im Bad und zaubern ein entspanntes Feeling.

ACCESSOIRES

Nos accessoires à poser sont disponibles dans divers matériaux. Avec de la céramique brillante ou mate, du verre coloré, du bois, du métal ou du plastique incassable, nous mettons de jolis accents de couleur dans la salle de bains et créons une sensation de détente.





WC-SITZE

Selbst ein Alltagsgegenstand, wie ein WC-Sitz wird mit unseren Produkten zum stylischen Hingucker im Badezimmer oder Gästebad. Wir schaffen es, mit verschiedenen Designs faszinierende Geschichten zu erzählen und unterstreichen zusätzlich die Farb- und Formensprache des Badezimmerstylings.

SIÈGES DE WC

Même un objet de tous les jours, comme un siège de WC, devient un accroche-regard stylé dans la salle de bains ou la salle de bains d'invités grâce à nos produits. Nous parvenons à raconter des histoires fascinantes avec différents designs et soulignons en outre le langage des couleurs et des formes du stylisme de la salle de bains.

AUFBEWAHRUNG

Wir bieten eine grosse Auswahl an smarten und stilvollen Aufbewahrungslösungen, wie Wäschekörbe, Organizer für Schminkutensilien oder kleinere Körbchen in stylischer Strickoptik und bringen damit Ordnung und Ästhetik in jedes Bad.

RANGEMENT

Nous proposons un grand choix de solutions de rangement intelligentes et élégantes, comme des paniers à linge, des organisateurs pour le maquillage ou des petits paniers au look tricoté stylé, et apportons ainsi ordre et esthétique dans chaque salle de bains.





Badezimmer- textilien und Zubehör

*Textiles de salle
de bains et
accessoires*

Kapitel 1 - Inhaltsverzeichnis

Chapitre 1 - Sommaire

| | |
|--|------|
| Duschvorhänge Textil <i>Rideaux de douche textile</i> | 1.6 |
| Duschvorhänge Kunststoff <i>Rideaux de douche plastique</i> | 1.19 |
| Duschvorhangstangen <i>Barres de rideaux de douche</i> | 1.28 |
| Duschvorhangringe <i>Anneaux de rideaux de douche</i> | 1.32 |
| Badezimmerteppiche <i>Tapis de salle de bains</i> | 1.38 |
| Frottiervorleger <i>Tapis en tissu éponge</i> | 1.45 |
| Wanneneinlagen <i>Tapis de bain antidérapants</i> | 1.48 |
| Antirutsch-Streifen <i>Bandes antidérapants</i> | 1.54 |
| Aufbewahrung <i>Rangement</i> | 1.58 |





Duschvorhänge (Textil)

Rideaux de douche (textile)

Hochwertiges Material

Matériau de haute qualité



Bestehend aus hochwertigem und wasserabweisendem Polyestergewebe (100%).

En tissu polyester (100%) déperlant de qualité.

Beschwerungsband

Ourllet lesté



aus Polypropylen (bleibfrei).

en polypropylène (sans plomb).

Stabile Ösen

Trous robustes



Passend für die Aufhängung mit Duschvorhangringen und Gleitern.

Convient pour la suspension avec des anneaux de rideau de douche et des patins.

Größen

Dimensions

Erhältlich in vier verschiedenen Größen: 120 x 200 cm, 180 x 180 cm, 180 x 200 cm, 240 x 180 cm - passend zu den gängigen Einbausituationen.

Disponibles en quatre tailles: 120 x 200 cm, 180 x 180 cm, 180 x 200 cm, 240 x 180 cm - pour les configurations d'installation.

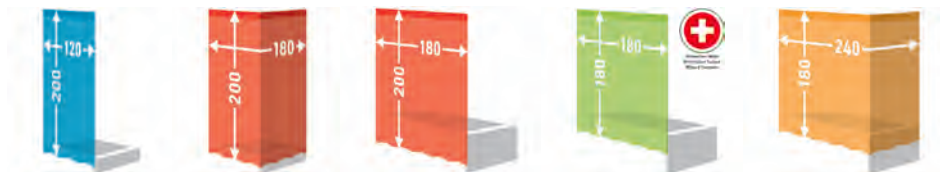

Duschvorhänge (Kunststoff)

Rideaux de douche (plastique)

Hochwertiges Material

Matériau de haute qualité



Hergestellt aus hochwertigem PEVA-Material (Polyethylen-Vinylacetat, PVC-frei).

En PEVA de qualité (polyéthylène vinyle acétate, sans PVC).

Vorgestanzte Ösen

Trous préperforés

Mit vorgestanzten Ösenlöcher für die Aufhängung mit Ringen und Gleitern.

Avec trous préperforés pour l'accrochage avec des anneaux ou des patins.

Größen

Dimensions

































Erhältlich in der Grösse 180 x 200 cm, können problemlos zugeschnitten werden.

Disponibles dans la taille 180 x 200 cm, faciles à couper sur mesure.



Duschvorhänge Textil

Rideaux de douche textile

| | EAN-Nr. no EAN | Artikel Nr. no d'article | Beschreibung description | VPE ce | VE ue | UVP pro Stk. PVC CHF excl. | UVP pro Stk. PVC CHF incl. |
|--|---|---|--|---|---|----------------------------------|----------------------------------|
|  <p>100% Polyester 100% polyester</p> |  | 81 0000 03 | Basic - weiss <i>Basic - blanc</i> 120 x 200 cm | 1 |  | 15.10 | 16.26 |
| |  | 81 0000 01 | Basic - weiss <i>Basic - blanc</i> 180 x 180 cm / CH | 1 |  | 20.04 | 21.58 |
| |  | 81 0000 02 | Basic - weiss <i>Basic - blanc</i> 180 x 200 cm | 1 |  | 24.70 | 26.60 |
| |  | 81 0000 04 | Basic - weiss <i>Basic - blanc</i> 240 x 180 cm | 1 |  | 35.41 | 38.14 |
| |  | 81 0000 11 | Basic - hell beige <i>Basic - beige claire</i> 120 x 200 cm | 1 |  | 15.10 | 16.26 |
| |  | 81 0000 09 | Basic - hell beige <i>Basic - beige claire</i> 180 x 180 cm / CH | 1 |  | 20.04 | 21.58 |
| |  | 81 0000 10 | Basic - hell beige <i>Basic - beige claire</i> 180 x 200 cm | 1 |  | 24.70 | 26.60 |
| |  | 81 0000 12 | Basic - hell beige <i>Basic - beige claire</i> 240 x 180 cm | 1 |  | 35.41 | 38.14 |
| |  | 81 0000 15 | Basic - grau <i>Basic - gris</i> 120 x 200 cm | 1 |  | 15.10 | 16.26 |
| |  | 81 0000 13 | Basic - grau <i>Basic - gris</i> 180 x 180 cm / CH | 1 |  | 20.04 | 21.58 |
| |  | 81 0000 14 | Basic - grau <i>Basic - gris</i> 180 x 200 cm | 1 |  | 24.70 | 26.60 |
| |  | 81 0000 16 | Basic - grau <i>Basic - gris</i> 240 x 180 cm | 1 |  | 35.41 | 38.14 |
| |  | 81 0000 19 | Basic - blau <i>Basic - bleu</i> 120 x 200 cm | 1 |  | 15.10 | 16.26 |
| |  | 81 0000 17 | Basic - blau <i>Basic - bleu</i> 180 x 180 cm / CH | 1 |  | 20.04 | 21.58 |
| |  | 81 0000 18 | Basic - blau <i>Basic - bleu</i> 180 x 200 cm | 1 |  | 24.70 | 26.60 |
|  | 81 0000 20 | Basic - blau <i>Basic - bleu</i> 240 x 180 cm | 1 |  | 35.41 | 38.14 | |

Duschvorhänge Textil

Rideaux de douche textile

| | EAN-Nr. no EAN | Artikel Nr. no d'article | Beschreibung description | VPE ce | VE ue | UVP pro Stk. PVC CHF excl. | UVP pro Stk. PVC CHF incl. |
|--|-------------------|-----------------------------|-----------------------------|-----------|----------|----------------------------------|----------------------------------|
|--|-------------------|-----------------------------|-----------------------------|-----------|----------|----------------------------------|----------------------------------|

Duschvorhang Textil

Rideau de douche textile



100% Polyester
100% polyester

| | | | | | | |
|--|-------------------|--------------------------------------|---|--|--------------|--------------|
|  | 81 0000 23 | Basic - coral 120 x 200 cm | 1 |  | 15.10 | 16.26 |
|  | 81 0000 21 | Basic - coral 180 x 180 cm / CH | 1 |  | 20.04 | 21.58 |
|  | 81 0000 22 | Basic - coral 180 x 200 cm | 1 |  | 24.70 | 26.60 |
|  | 81 0000 24 | Basic - coral 240 x 180 cm | 1 |  | 35.41 | 38.14 |
|  | 81 0000 27 | Basic - pacific 120 x 200 cm | 1 |  | 15.10 | 16.26 |
|  | 81 0000 25 | Basic - pacific 180 x 180 cm / CH | 1 |  | 20.04 | 21.58 |
|  | 81 0000 26 | Basic - pacific 180 x 200 cm | 1 |  | 24.70 | 26.60 |
|  | 81 0000 28 | Basic - pacific 240 x 180 cm | 1 |  | 35.41 | 38.14 |











Duschvorhang Textil

Rideau de douche textile











100% Polyester
100% polyester









| | | | | | | |
|---|-------------------|---------------------------|---|---|--------------|--------------|
|  | 81 0001 83 | Mesh 120 x 200 cm | 1 |  | 20.04 | 21.58 |
|  | 81 0001 81 | Mesh 180 x 180 cm / CH | 1 |  | 24.70 | 26.60 |
|  | 81 0001 82 | Mesh 180 x 200 cm | 1 |  | 30.29 | 32.62 |
|  | 81 0001 84 | Mesh 240 x 180 cm | 1 |  | 40.07 | 43.16 |









Duschvorhänge Textil

Rideaux de douche textile

| | EAN-Nr. no EAN | Artikel Nr. no d'article | Beschreibung description | VPE ce | VE ue | UVP pro Stk. PVC CHF excl. | UVP pro Stk. PVC CHF incl. |
|--|-------------------|-----------------------------|-----------------------------|-----------|----------|----------------------------------|----------------------------------|
|--|-------------------|-----------------------------|-----------------------------|-----------|----------|----------------------------------|----------------------------------|

| Duschvorhang Textil | | Rideau de douche textile | | | | | |
|--|---|--------------------------|---------------------------|---|---|--------------|--------------|
|  <p>100% Polyester 100% polyester</p> |  | 81 0001 03 | Mare 120 x 200 cm | 1 |  | 20.04 | 21.58 |
| |  | 81 0001 01 | Mare 180 x 180 cm / CH | 1 |  | 24.70 | 26.60 |
| |  | 81 0001 02 | Mare 180 x 200 cm | 1 |  | 30.29 | 32.62 |
| |  | 81 0001 04 | Mare 240 x 180 cm | 1 |  | 40.07 | 43.16 |

| Duschvorhang Textil | | Rideau de douche textile | | | | | |
|---|---|--------------------------|-----------------------------|---|---|--------------|--------------|
|  <p>100% Polyester 100% polyester</p> |  | 81 0001 87 | Anchor 120 x 200 cm | 1 |  | 20.04 | 21.58 |
| |  | 81 0001 85 | Anchor 180 x 180 cm / CH | 1 |  | 24.70 | 26.60 |
| |  | 81 0001 86 | Anchor 180 x 200 cm | 1 |  | 30.29 | 32.62 |
| |  | 81 0001 88 | Anchor 240 x 180 cm | 1 |  | 40.07 | 43.16 |

| Duschvorhang Textil | | Rideau de douche textile | | | | | |
|--|---|--------------------------|----------------------------|---|---|--------------|--------------|
|  <p>100% Polyester 100% polyester</p> |  | 81 0001 91 | Scuby 120 x 200 cm | 1 |  | 20.04 | 21.58 |
| |  | 81 0001 89 | Scuby 180 x 180 cm / CH | 1 |  | 24.70 | 26.60 |
| |  | 81 0001 90 | Scuby 180 x 200 cm | 1 |  | 30.29 | 32.62 |
| |  | 81 0001 92 | Scuby 240 x 180 cm | 1 |  | 40.07 | 43.16 |

Duschvorhänge Textil

Rideaux de douche textile









| | EAN-Nr. no EAN | Artikel Nr. no d'article | Beschreibung description | VPE ce | VE ue | UVP pro Stk. PVC CHF excl. | UVP pro Stk. PVC CHF incl. |
|--|-------------------|-----------------------------|-----------------------------|-----------|----------|----------------------------------|----------------------------------|
|--|-------------------|-----------------------------|-----------------------------|-----------|----------|----------------------------------|----------------------------------|

Duschvorhang Textil

Rideau de douche textile



100% Polyester
100% polyester







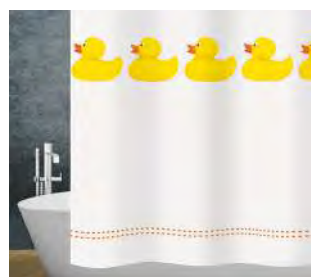

| | | | | | | |
|---|-------------------|---------------------------|---|---|--------------|--------------|
|  | 81 0002 11 | City 120 x 200 cm | 1 |  | 30.29 | 32.62 |
|  | 81 0002 09 | City 180 x 180 cm / CH | 1 |  | 35.41 | 38.14 |
|  | 81 0002 10 | City 180 x 200 cm | 1 |  | 40.07 | 43.16 |
|  | 81 0002 12 | City 240 x 180 cm | 1 |  | 49.39 | 53.20 |

Duschvorhang Textil

Rideau de douche textile



100% Polyester
100% polyester









| | | | | | | |
|---|-------------------|-----------------------------|---|---|--------------|--------------|
|  | 81 0001 19 | Duckie 120 x 200 cm | 1 |  | 20.04 | 21.58 |
|  | 81 0001 17 | Duckie 180 x 180 cm / CH | 1 |  | 24.70 | 26.60 |
|  | 81 0001 18 | Duckie 180 x 200 cm | 1 |  | 30.29 | 32.62 |
|  | 81 0001 20 | Duckie 240 x 180 cm | 1 |  | 40.07 | 43.16 |

Duschvorhang Textil

Rideau de douche textile











100% Polyester
100% polyester

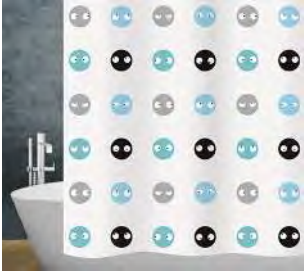







| | | | | | | |
|---|-------------------|----------------------------|---|---|--------------|--------------|
|  | 81 0001 27 | Point 120 x 200 cm | 1 |  | 20.04 | 21.58 |
|  | 81 0001 25 | Point 180 x 180 cm / CH | 1 |  | 24.70 | 26.60 |
|  | 81 0001 26 | Point 180 x 200 cm | 1 |  | 30.29 | 32.62 |
|  | 81 0001 28 | Point 240 x 180 cm | 1 |  | 40.07 | 43.16 |









Duschvorhänge Textil

Rideaux de douche textile

| | EAN-Nr. no EAN | Artikel Nr. no d'article | Beschreibung description | VPE ce | VE ue | UVP pro Stk. PVC CHF excl. | UVP pro Stk. PVC CHF incl. |
|--|-------------------|-----------------------------|-----------------------------|-----------|----------|----------------------------------|----------------------------------|
|--|-------------------|-----------------------------|-----------------------------|-----------|----------|----------------------------------|----------------------------------|

| Duschvorhang Textil | Rideau de douche textile | | | | | | |
|--|---|-------------------|--------------------------|---|---|--------------|--------------|
|  <p>100% Polyester 100% polyester</p> |  | 81 0001 55 | Emo 120 x 200 cm | 1 |  | 20.04 | 21.58 |
| |  | 81 0001 53 | Emo 180 x 180 cm / CH | 1 |  | 24.70 | 26.60 |
| |  | 81 0001 54 | Emo 180 x 200 cm | 1 |  | 30.29 | 32.62 |
| |  | 81 0001 56 | Emo 240 x 180 cm | 1 |  | 40.07 | 43.16 |









| Duschvorhang Textil | Rideau de douche textile | | | | | | |
|---|---|-------------------|---------------------------|---|---|--------------|--------------|
|  <p>100% Polyester 100% polyester</p> |  | 81 0001 59 | Love 120 x 200 cm | 1 |  | 20.04 | 21.58 |
| |  | 81 0001 57 | Love 180 x 180 cm / CH | 1 |  | 24.70 | 26.60 |
| |  | 81 0001 58 | Love 180 x 200 cm | 1 |  | 30.29 | 32.62 |
| |  | 81 0001 60 | Love 240 x 180 cm | 1 |  | 40.07 | 43.16 |









| Duschvorhang Textil | Rideau de douche textile | | | | | | |
|--|---|-------------------|-----------------------------|---|---|--------------|--------------|
|  <p>100% Polyester 100% polyester</p> |  | 81 0001 07 | Clouds 120 x 200 cm | 1 |  | 30.29 | 32.62 |
| |  | 81 0001 05 | Clouds 180 x 180 cm / CH | 1 |  | 35.41 | 38.14 |
| |  | 81 0001 06 | Clouds 180 x 200 cm | 1 |  | 40.07 | 43.16 |
| |  | 81 0001 08 | Clouds 240 x 180 cm | 1 |  | 49.39 | 53.20 |

Duschvorhänge Textil

Rideaux de douche textile

| EAN-Nr. no EAN | Artikel Nr. no d'article | Beschreibung description | VPE ce | VE ue | UVP pro Stk. PVC CHF excl. | UVP pro Stk. PVC CHF incl. |
|-------------------|-----------------------------|-----------------------------|-----------|----------|----------------------------------|----------------------------------|
|-------------------|-----------------------------|-----------------------------|-----------|----------|----------------------------------|----------------------------------|

| Duschvorhang Textil | | Rideau de douche textile | | | | | |
|--|--|--------------------------|---------------------------|---|---|--------------|--------------|
|  <p>100% Polyester 100% polyester</p> |  7 611038 247386 | 81 0001 11 | Arty 120 x 200 cm | 1 |  | 30.29 | 32.62 |
| |  7 611038 247362 | 81 0001 09 | Arty 180 x 180 cm / CH | 1 |  | 35.41 | 38.14 |
| |  7 611038 247379 | 81 0001 10 | Arty 180 x 200 cm | 1 |  | 40.07 | 43.16 |
| |  7 611038 247393 | 81 0001 12 | Arty 240 x 180 cm | 1 |  | 49.39 | 53.20 |

| Duschvorhang Textil | | Rideau de douche textile | | | | | |
|---|--|--------------------------|---|---|---|--------------|--------------|
|  <p>100% Polyester 100% polyester</p> |  7 611038 186302 | 81 0002 07 | Andalus 120 x 200 cm | 1 |  | 30.29 | 32.62 |
| |  7 611038 186289 | 81 0002 05 | Andalus Andalus 180 x 180 cm / CH | 1 |  | 35.41 | 38.14 |
| |  7 611038 186296 | 81 0002 06 | Andalus 180 x 200 cm | 1 |  | 40.07 | 43.16 |
| |  7 611038 186234 | 81 0002 08 | Andalus 240 x 180 cm | 1 |  | 49.39 | 53.20 |

| Duschvorhang Textil | | Rideau de douche textile | | | | | |
|--|--|--------------------------|----------------------------|---|---|--------------|--------------|
|  <p>100% Polyester 100% polyester</p> |  7 611038 852238 | 81 0001 95 | Missy 120 x 200 cm | 1 |  | 30.29 | 32.62 |
| |  7 611038 852245 | 81 0001 93 | Missy 180 x 180 cm / CH | 1 |  | 35.41 | 38.14 |
| |  7 611038 852221 | 81 0001 94 | Missy 180 x 200 cm | 1 |  | 40.07 | 43.16 |
| |  7 611038 852351 | 81 0001 96 | Missy 240 x 180 cm | 1 |  | 49.39 | 53.20 |

Duschvorhänge Textil

Rideaux de douche textile







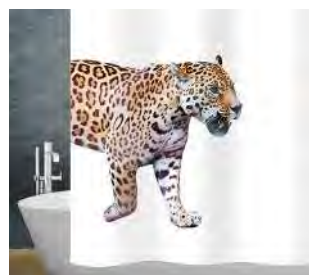

| EAN-Nr. no EAN | Artikel Nr. no d'article | Beschreibung description | VPE ce | VE ue | UVP pro Stk. PVC CHF excl. | UVP pro Stk. PVC CHF incl. |
|-------------------|-----------------------------|-----------------------------|-----------|----------|----------------------------------|----------------------------------|
|-------------------|-----------------------------|-----------------------------|-----------|----------|----------------------------------|----------------------------------|

Duschvorhang Textil

Rideau de douche textile



100% Polyester
100% polyester

| | | | | | | |
|---|-------------------|-----------------------------|---|---|--------------|--------------|
|  7 611038 186531 | 81 0002 27 | Jaguar 120 x 200 cm | 1 |  | 40.07 | 43.16 |
|  7 611038 186517 | 81 0002 25 | Jaguar 180 x 180 cm / CH | 1 |  | 45.67 | 49.18 |
|  7 611038 186524 | 81 0002 26 | Jaguar 180 x 200 cm | 1 |  | 49.39 | 53.20 |
|  7 611038 186548 | 81 0002 28 | Jaguar 240 x 180 cm | 1 |  | 60.58 | 65.24 |

Duschvorhang Textil

Rideau de douche textile



100% Polyester
100% polyester







| | | | | | | |
|---|-------------------|--|---|---|--------------|--------------|
|  7 611038 186494 | 81 0002 23 | Flamingo Flammant 120 x 200 cm | 1 |  | 30.29 | 32.62 |
|  7 611038 186470 | 81 0002 21 | Flamingo Flamant 180 x 180 cm / CH | 1 |  | 35.41 | 38.14 |
|  7 611038 186487 | 81 0002 22 | Flamingo Flammant 180 x 200 cm | 1 |  | 40.07 | 43.16 |
|  7 611038 186500 | 81 0002 24 | Flamingo Flammant 240 x 180 cm | 7 |  | 49.39 | 53.20 |

Duschvorhang Textil

Rideau de douche textile



100% Polyester
100% polyester

| | | | | | | |
|---|-------------------|-----------------------------|---|---|--------------|--------------|
|  7 611038 186456 | 81 0002 19 | Bamboo 120 x 200 cm | 1 |  | 30.29 | 32.62 |
|  7 611038 186432 | 81 0002 17 | Bamboo 180 x 180 cm / CH | 1 |  | 35.41 | 38.14 |
|  7 611038 186449 | 81 0002 18 | Bamboo 180 x 200 cm | 1 |  | 40.07 | 43.16 |
|  7 611038 186463 | 81 0002 20 | Bamboo 240 x 180 cm | 1 |  | 49.39 | 53.20 |

Duschvorhänge Textil

Rideaux de douche textile









| | EAN-Nr. no EAN | Artikel Nr. no d'article | Beschreibung description | VPE ce | VE ue | UVP pro Stk. PVC CHF excl. | UVP pro Stk. PVC CHF incl. |
|--|-------------------|-----------------------------|-----------------------------|-----------|----------|----------------------------------|----------------------------------|
|--|-------------------|-----------------------------|-----------------------------|-----------|----------|----------------------------------|----------------------------------|

Duschvorhang Textil

Rideau de douche textile



100% Polyester
100% polyester

| | | | | | | |
|---|-------------------|------------------------------|---|---|--------------|--------------|
|  | 81 0001 67 | Palmier 120 x 200 cm | 1 |  | 30.29 | 32.62 |
|  | 81 0001 65 | Palmier 180 x 180 cm / CH | 1 |  | 35.41 | 38.14 |
|  | 81 0001 66 | Palmier 180 x 200 cm | 6 |  | 40.07 | 43.16 |
|  | 81 0001 68 | Palmier 240 x 180 cm | 1 |  | 49.39 | 53.20 |

Duschvorhang Textil

Rideau de douche textile



100% Polyester
100% polyester









| | | | | | | |
|---|-------------------|---------------------------|---|---|--------------|--------------|
|  | 81 0001 15 | Joya 120 x 200 cm | 1 |  | 30.29 | 32.62 |
|  | 81 0001 13 | Joya 180 x 180 cm / CH | 1 |  | 35.41 | 38.14 |
|  | 81 0001 14 | Joya 180 x 200 cm | 1 |  | 40.07 | 43.16 |
|  | 81 0001 16 | Joya 240 x 180 cm | 1 |  | 49.39 | 53.20 |

Duschvorhang Textil

Rideau de douche textile



100% Polyester
100% polyester

| | | | | | | |
|---|-------------------|-------------------------------|---|---|--------------|--------------|
|  | 81 0001 35 | Papillon 120 x 200 cm | 1 |  | 40.07 | 43.16 |
|  | 81 0001 33 | Papillon 180 x 180 cm / CH | 1 |  | 45.67 | 49.18 |
|  | 81 0001 34 | Papillon 180 x 200 cm | 1 |  | 49.39 | 53.20 |
|  | 81 0001 36 | Papillon 240 x 180 cm | 1 |  | 60.58 | 65.24 |

Duschvorhänge Textil

Rideaux de douche textile







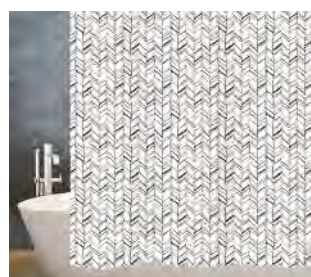

| EAN-Nr. no EAN | Artikel Nr. no d'article | Beschreibung description | VPE ce | VE ue | UVP pro Stk. PVC CHF excl. | UVP pro Stk. PVC CHF incl. |
|-------------------|-----------------------------|-----------------------------|-----------|----------|----------------------------------|----------------------------------|
|-------------------|-----------------------------|-----------------------------|-----------|----------|----------------------------------|----------------------------------|

Duschvorhang Textil

Rideau de douche textile



100% Polyester
100% polyester







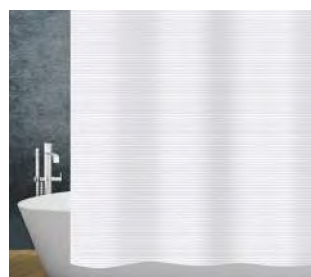

| | | | | | | |
|--|-------------------|------------------------------|---|---|--------------|--------------|
|  7 611038 852450 | 81 0001 99 | Chevron 120 x 200 cm | 1 |  | 40.07 | 43.16 |
|  7 611038 852573 | 81 0001 97 | Chevron 180 x 180 cm / CH | 1 |  | 45.67 | 49.18 |
|  7 611038 852467 | 81 0001 98 | Chevron 180 x 200 cm | 1 |  | 49.39 | 53.20 |
|  7 611038 852337 | 81 0002 00 | Chevron 240 x 180 cm | 1 |  | 60.58 | 65.24 |

Duschvorhang Textil

Rideau de douche textile



100% Polyester
100% polyester









| | | | | | | |
|--|-------------------|----------------------------|---|---|--------------|--------------|
|  7 611038 247706 | 81 0001 43 | Linea 120 x 200 cm | 1 |  | 40.07 | 43.16 |
|  7 611038 247683 | 81 0001 41 | Linea 180 x 180 cm / CH | 1 |  | 45.67 | 49.18 |
|  7 611038 247690 | 81 0001 42 | Linea 180 x 200 cm | 1 |  | 49.39 | 53.20 |
|  7 611038 247713 | 81 0001 44 | Linea 240 x 180 cm | 1 |  | 60.58 | 65.24 |

Duschvorhang Textil

Rideau de douche textile



100% Polyester
100% polyester

| | | | | | | |
|--|-------------------|-----------------------------|---|---|--------------|--------------|
|  7 611038 247782 | 81 0001 51 | Stones 120 x 200 cm | 1 |  | 40.07 | 43.16 |
|  7 611038 247768 | 81 0001 49 | Stones 180 x 180 cm / CH | 1 |  | 45.67 | 49.18 |
|  7 611038 247775 | 81 0001 50 | Stones 180 x 200 cm | 1 |  | 49.39 | 53.20 |
|  7 611038 247799 | 81 0001 52 | Stones 240 x 180 cm | 1 |  | 60.58 | 65.24 |

Duschvorhänge Textil

Rideaux de douche textile









| | EAN-Nr. no EAN | Artikel Nr. no d'article | Beschreibung description | VPE ce | VE ue | UVP pro Stk. PVC CHF excl. | UVP pro Stk. PVC CHF incl. |
|--|-------------------|-----------------------------|-----------------------------|-----------|----------|----------------------------------|----------------------------------|
|--|-------------------|-----------------------------|-----------------------------|-----------|----------|----------------------------------|----------------------------------|

Duschvorhang Textil

Rideau de douche textile



100% Polyester
100% polyester









| | | | | | | |
|---|-------------------|-----------------------------|---|---|--------------|--------------|
|  | 81 0001 75 | Pueblo 120 x 200 cm | 1 |  | 40.07 | 43.16 |
|  | 81 0001 73 | Pueblo 180 x 180 cm / CH | 1 |  | 45.67 | 49.18 |
|  | 81 0001 74 | Pueblo 180 x 200 cm | 1 |  | 49.39 | 53.20 |
|  | 81 0001 76 | Pueblo 240 x 180 cm | 1 |  | 60.58 | 65.24 |

Duschvorhang Textil

Rideau de douche textile



100% Polyester
100% polyester

| | | | | | | |
|---|-------------------|------------------------------|---|---|--------------|--------------|
|  | 81 0001 39 | Pergola 120 x 200 cm | 1 |  | 40.07 | 43.16 |
|  | 81 0001 37 | Pergola 180 x 180 cm / CH | 1 |  | 45.67 | 49.18 |
|  | 81 0001 38 | Pergola 180 x 200 cm | 1 |  | 49.39 | 53.20 |
|  | 81 0001 40 | Pergola 240 x 180 cm | 1 |  | 60.58 | 65.24 |

Duschvorhang Textil

Rideau de douche textile



100% Polyester
100% polyester

| | | | | | | |
|---|-------------------|------------------------------|---|---|--------------|--------------|
|  | 81 0001 31 | Aquatic 120 x 200 cm | 1 |  | 40.07 | 43.16 |
|  | 81 0001 29 | Aquatic 180 x 180 cm / CH | 1 |  | 45.67 | 49.18 |
|  | 81 0001 30 | Aquatic 180 x 200 cm | 1 |  | 49.39 | 53.20 |
|  | 81 0001 32 | Aquatic 240 x 180 cm | 1 |  | 60.58 | 65.24 |

Duschvorhänge Textil

Rideaux de douche textile

| EAN-Nr. no EAN | Artikel Nr. no d'article | Beschreibung description | VPE ce | VE ue | UVP pro Stk. PVC CHF excl. | UVP pro Stk. PVC CHF incl. |
|-------------------|-----------------------------|-----------------------------|-----------|----------|----------------------------------|----------------------------------|
|-------------------|-----------------------------|-----------------------------|-----------|----------|----------------------------------|----------------------------------|

Duschvorhang Textil

Rideau de douche textile



100% Polyester
100% polyester

| | | | | | | |
|--|-------------------|-----------------------------|---|---|--------------|--------------|
|  7 611038 852283 | 81 0002 03 | Giotto 120 x 200 cm | 1 |  | 40.07 | 43.16 |
|  7 611038 852276 | 81 0002 01 | Giotto 180 x 180 cm / CH | 1 |  | 45.67 | 49.18 |
|  7 611038 852269 | 81 0002 02 | Giotto 180 x 200 cm | 1 |  | 49.39 | 53.20 |
|  7 611038 852290 | 81 0002 04 | Giotto 240 x 180 cm | 1 |  | 60.58 | 65.24 |

Duschvorhang Textil

Rideau de douche textile



100% Polyester
100% polyester

| | | | | | | |
|--|-------------------|---------------------------------|---|---|--------------|--------------|
|  7 611038 247744 | 81 0001 47 | Casablanca 120 x 200 cm | 1 |  | 40.07 | 43.16 |
|  7 611038 247720 | 81 0001 45 | Casablanca 180 x 180 cm / CH | 1 |  | 45.67 | 49.18 |
|  7 611038 247737 | 81 0001 46 | Casablanca 180 x 200 cm | 1 |  | 49.39 | 53.20 |
|  7 611038 247751 | 81 0001 48 | Casablanca 240 x 180 cm | 1 |  | 60.58 | 65.24 |

Duschvorhang Textil

Rideau de douche textile











100% Polyester
100% polyester









| | | | | | | |
|--|-------------------|--------------------------|---|---|--------------|--------------|
|  7 611038 495992 | 81 0002 31 | Spa 120 x 200 cm | 1 |  | 40.07 | 43.16 |
|  7 611038 188948 | 81 0002 29 | Spa 180 x 180 cm / CH | 1 |  | 45.67 | 49.18 |
|  7 611038 495985 | 81 0002 30 | Spa 180 x 200 cm | 1 |  | 49.39 | 53.20 |
|  7 611038 496005 | 81 0002 32 | Spa 240 x 180 cm | 1 |  | 60.58 | 65.24 |

Duschvorhänge Textil

Rideaux de douche textile

| | EAN-Nr. no EAN | Artikel Nr. no d'article | Beschreibung description | VPE ce | VE ue | UVP pro Stk. PVC CHF excl. | UVP pro Stk. PVC CHF incl. |
|--|-------------------|-----------------------------|-----------------------------|-----------|----------|----------------------------------|----------------------------------|
|--|-------------------|-----------------------------|-----------------------------|-----------|----------|----------------------------------|----------------------------------|

| Duschvorhang Textil | | Rideau de douche textile | | | | | |
|--|---|--------------------------|----------------------------------|---|---|--------------|--------------|
|  <p>100% Polyester 100% polyester</p> |  | 81 0002 35 | Swiss Dream 120 x 200 cm | 1 |  | 40.07 | 43.16 |
| |  | 81 0002 33 | Swiss Dream 180 x 180 cm / CH | 1 |  | 45.67 | 49.18 |
| |  | 81 0002 34 | Swiss Dream 180 x 200 cm | 1 |  | 49.39 | 53.20 |
| |  | 81 0002 36 | Swiss Dream 240 x 180 cm | 1 |  | 60.58 | 65.24 |

| Duschvorhang Textil | | Rideau de douche textile | | | | | |
|---|---|--------------------------|--------------------------------|---|---|--------------|--------------|
|  <p>100% Polyester 100% polyester</p> |  | 81 0002 39 | Edelweiss 120 x 200 cm | 1 |  | 30.29 | 32.62 |
| |  | 81 0002 37 | Edelweiss 180 x 180 cm / CH | 1 |  | 35.41 | 38.14 |
| |  | 81 0002 38 | Edelweiss 180 x 200 cm | 1 |  | 40.07 | 43.16 |
| |  | 81 0002 40 | Edelweiss 240 x 180 cm | 1 |  | 49.39 | 53.20 |

Duschvorhänge Textil

Rideaux de douche textile

| EAN-Nr. no EAN | Artikel Nr. no d'article | Beschreibung description | VPE ce | VE ue | UVP pro Stk. PVC CHF excl. | UVP pro Stk. PVC CHF incl. |
|-------------------|-----------------------------|-----------------------------|-----------|----------|----------------------------------|----------------------------------|
|-------------------|-----------------------------|-----------------------------|-----------|----------|----------------------------------|----------------------------------|

NEW

Duschvorhang Textil Rideau de douche textile



81 0012 42

Marina
180 x 200 cm ; PAPER BAG

1



32.57

35.08



Hergestellt aus 100% recycelten PET-Flaschen
Fabriqué en 100% bouteilles PET recyclées.

NEW

Duschvorhang Textil Rideau de douche textile



81 0012 46

Liana
180 x 200 cm ; PAPER BAG

1



32.57

35.08



Hergestellt aus 100% recycelten PET-Flaschen
Fabriqué en 100% bouteilles PET recyclées.

NEW

Duschvorhang Textil Rideau de douche textile



81 0012 50

Dune
180 x 200 cm ; PAPER BAG

1



32.57

35.08

















Hergestellt aus 100% recycelten PET-Flaschen
Fabriqué en 100% bouteilles PET recyclées.

Duschvorhänge Kunststoff

Rideaux de douche plastique

| EAN-Nr. no EAN | Artikel Nr. no d'article | Beschreibung description | VPE ce | VE ue | UVP pro Stk. PVC CHF excl. | UVP pro Stk. PVC CHF incl. |
|-------------------|-----------------------------|-----------------------------|-----------|----------|----------------------------------|----------------------------------|
|-------------------|-----------------------------|-----------------------------|-----------|----------|----------------------------------|----------------------------------|

| Duschvorhang PEVA | | Rideau de douche PEVA | | | | | |
|--|--|-----------------------|---|---|---|--------------|--------------|
|  <p>100% Peva</p> |  7 611038 186142 | 81 0100 69 | Claro - weiss <i>Claro - blanc</i> 180 x 200 cm | 6 |  | 15.10 | 16.26 |
| |  7 611038 186159 | 81 0100 73 | Claro - hellblau <i>Claro - bleu claire</i> 180 x 200 cm | 1 |  | 15.10 | 16.26 |
| |  7 611038 186166 | 81 0100 77 | Claro - hellgrau <i>Claro - gris claire</i> 180 x 200 cm | 1 |  | 15.10 | 16.26 |
| |  7 611038 495978 | 81 0100 85 | Claro - dunkelgrau <i>Claro - gris foncé</i> 180 x 200 cm | 1 |  | 15.10 | 16.26 |
| |  7 611038 760939 | 81 0100 81 | Claro - transparent 180 x 200 cm | 1 |  | 15.10 | 16.26 |
|  | | | | | | | |

| Duschvorhang PEVA | | Rideau de douche PEVA | | | | | |
|--|--|-----------------------|------------------------|---|---|--------------|--------------|
|  <p>100% Peva</p> |  7 611038 186043 | 81 0100 25 | Prisma 180 x 200 cm | 1 |  | 20.04 | 21.58 |

| Duschvorhang PEVA | | Rideau de douche PEVA | | | | | |
|--|--|-----------------------|---------------------|---|---|--------------|--------------|
|  <p>100% Peva</p> |  7 611038 186050 | 81 0100 29 | Owl 180 x 200 cm | 6 |  | 20.04 | 21.58 |

Duschvorhänge Kunststoff

Rideaux de douche plastique

| | EAN-Nr. no EAN | Artikel Nr. no d'article | Beschreibung description | VPE ce | VE ue | UVP pro Stk. PVC CHF excl. | UVP pro Stk. PVC CHF incl. |
|--|-------------------|-----------------------------|-----------------------------|-----------|----------|----------------------------------|----------------------------------|
|--|-------------------|-----------------------------|-----------------------------|-----------|----------|----------------------------------|----------------------------------|

| Duschvorhang PEVA | Rideau de douche PEVA | | | | | | |
|-------------------|-----------------------|--|--|--|--|--|--|
|-------------------|-----------------------|--|--|--|--|--|--|





100% Peva

| | | | | | | |
|---|-------------------|------------------------|---|---|--------------|--------------|
|  | 81 0100 33 | Ribbon 180 x 200 cm | 1 |  | 20.04 | 21.58 |
|---|-------------------|------------------------|---|---|--------------|--------------|

| Duschvorhang PEVA | Rideau de douche PEVA | | | | | | |
|-------------------|-----------------------|--|--|--|--|--|--|
|-------------------|-----------------------|--|--|--|--|--|--|



100% Peva

| | | | | | | |
|---|-------------------|------------------------|---|---|--------------|--------------|
|  | 81 0100 37 | School 180 x 200 cm | 6 |  | 20.04 | 21.58 |
|---|-------------------|------------------------|---|---|--------------|--------------|

| Duschvorhang PEVA | Rideau de douche PEVA | | | | | | |
|-------------------|-----------------------|--|--|--|--|--|--|
|-------------------|-----------------------|--|--|--|--|--|--|



100% Peva

| | | | | | | |
|---|-------------------|----------------------------|---|---|--------------|--------------|
|  | 81 0100 41 | Polar Bear 180 x 200 cm | 6 |  | 20.04 | 21.58 |
|---|-------------------|----------------------------|---|---|--------------|--------------|

| Duschvorhang PEVA | Rideau de douche PEVA | | | | | | |
|-------------------|-----------------------|--|--|--|--|--|--|
|-------------------|-----------------------|--|--|--|--|--|--|



100% Peva

| | | | | | | |
|---|-------------------|-------------------------|---|---|--------------|--------------|
|  | 81 0100 45 | Skyline 180 x 200 cm | 6 |  | 20.04 | 21.58 |
|---|-------------------|-------------------------|---|---|--------------|--------------|

Duschvorhänge Kunststoff

Rideaux de douche plastique



| EAN-Nr. no EAN | Artikel Nr. no d'article | Beschreibung description | VPE ce | VE ue | UVP pro Stk. PVC CHF excl. | UVP pro Stk. PVC CHF incl. |
|-------------------|-----------------------------|-----------------------------|-----------|----------|----------------------------------|----------------------------------|
|-------------------|-----------------------------|-----------------------------|-----------|----------|----------------------------------|----------------------------------|

Duschvorhang PEVA

Rideau de douche PEVA



100% Peva



| | | | | | | |
|--|-------------------|-------------------------|---|---|--------------|--------------|
|  7 611038 186104 | 81 0100 49 | Palmito 180 x 200 cm | 6 |  | 20.04 | 21.58 |
|--|-------------------|-------------------------|---|---|--------------|--------------|

Duschvorhang PEVA

Rideau de douche PEVA



100% Peva



| | | | | | | |
|--|-------------------|------------------------|---|---|--------------|--------------|
|  7 611038 186111 | 81 0100 53 | Quadro 180 x 200 cm | 6 |  | 20.04 | 21.58 |
|--|-------------------|------------------------|---|---|--------------|--------------|

Duschvorhang PEVA

Rideau de douche PEVA



100% Peva



| | | | | | | |
|--|-------------------|----------------------|---|---|--------------|--------------|
|  7 611038 186128 | 81 0100 57 | Dots 180 x 200 cm | 6 |  | 20.04 | 21.58 |
|--|-------------------|----------------------|---|---|--------------|--------------|

Duschvorhang PEVA

Rideau de douche PEVA



100% Peva

| | | | | | | |
|--|-------------------|------------------------|---|---|--------------|--------------|
|  7 611038 186135 | 81 0100 61 | Mosaik 180 x 200 cm | 6 |  | 20.04 | 21.58 |
|--|-------------------|------------------------|---|---|--------------|--------------|

Duschvorhänge Kunststoff

Rideaux de douche plastique



| | EAN-Nr. no EAN | Artikel Nr. no d'article | Beschreibung description | VPE ce | VE ue | UVP pro Stk. PVC CHF excl. | UVP pro Stk. PVC CHF incl. |
|--|-------------------|-----------------------------|-----------------------------|-----------|----------|----------------------------------|----------------------------------|
|--|-------------------|-----------------------------|-----------------------------|-----------|----------|----------------------------------|----------------------------------|

Duschvorhang PEVA

Rideau de douche PEVA



100% Peva



| | | | | | | |
|---|-------------------|---------------------|---|---|--------------|--------------|
|  | 81 0100 01 | Cat 180 x 200 cm | 6 |  | 20.04 | 21.58 |
|---|-------------------|---------------------|---|---|--------------|--------------|

Duschvorhang PEVA

Rideau de douche PEVA



100% Peva



| | | | | | | |
|---|-------------------|-----------------------|---|---|--------------|--------------|
|  | 81 0100 13 | Moods 180 x 200 cm | 6 |  | 20.04 | 21.58 |
|---|-------------------|-----------------------|---|---|--------------|--------------|

Duschvorhang PEVA

Rideau de douche PEVA



100% Peva



| | | | | | | |
|---|-------------------|----------------------|---|---|--------------|--------------|
|  | 81 0100 05 | Rain 180 x 200 cm | 6 |  | 20.04 | 21.58 |
|---|-------------------|----------------------|---|---|--------------|--------------|

Duschvorhang PEVA

Rideau de douche PEVA



100% Peva

| | | | | | | |
|---|-------------------|-----------------------|---|---|--------------|--------------|
|  | 81 0100 17 | Rombo 180 x 200 cm | 6 |  | 20.04 | 21.58 |
|---|-------------------|-----------------------|---|---|--------------|--------------|

Duschvorhänge Kunststoff

Rideaux de douche plastique



| EAN-Nr. <i>no EAN</i> | Artikel Nr. <i>no d'article</i> | Beschreibung <i>description</i> | VPE <i>ce</i> | VE <i>ue</i> | UVP pro Stk. <i>PVC</i> CHF excl. | UVP pro Stk. <i>PVC</i> CHF incl. |
|--------------------------|------------------------------------|------------------------------------|------------------|-----------------|---|---|
|--------------------------|------------------------------------|------------------------------------|------------------|-----------------|---|---|

Duschvorhang PEVA

Rideau de douche PEVA



100% Peva



| | | | | | | |
|--|-------------------|----------------------|---|---|--------------|--------------|
|  7 611038 247904 | 81 0100 09 | Leaf 180 x 200 cm | 6 |  | 20.04 | 21.58 |
|--|-------------------|----------------------|---|---|--------------|--------------|

Duschvorhang PEVA

Rideau de douche PEVA



100% Peva

| | | | | | | |
|--|-------------------|----------------------|---|---|--------------|--------------|
|  7 611038 184117 | 81 0100 21 | Fish 180 x 200 cm | 6 |  | 20.04 | 21.58 |
|--|-------------------|----------------------|---|---|--------------|--------------|

Seite / Page
4.54

Seite / Page
1.12

Seite / Page
2.56

Seite / Page
2.55

Seite / Page
2.33

Seite / Page
1.38

Seite / Page
4.17

Seite / Page
1.72





Seite / Page
1.13



Seite / Page
4.54



Seite / Page
2.23



Seite / Page
2.23

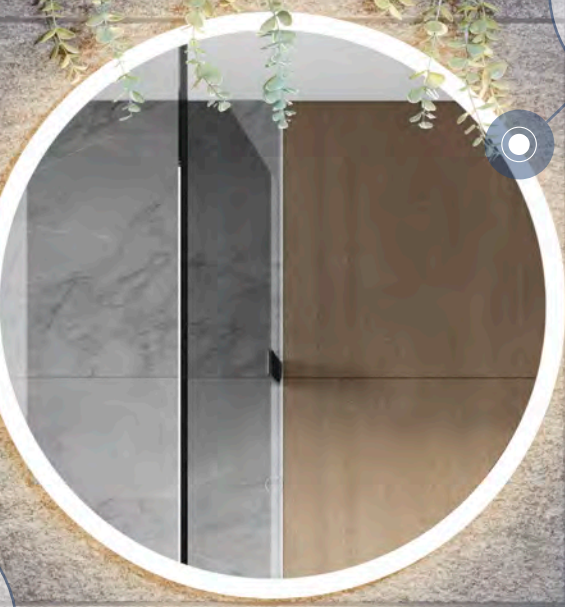

Seite / Page
1.62



Seite / Page
1.69



Seite / Page
5.81



Seite / Page
1.68



Seite / Page
4.19

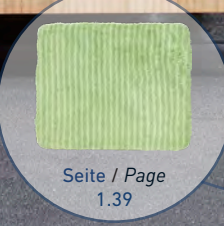

Seite / Page
1.39



Seite / Page
2.22

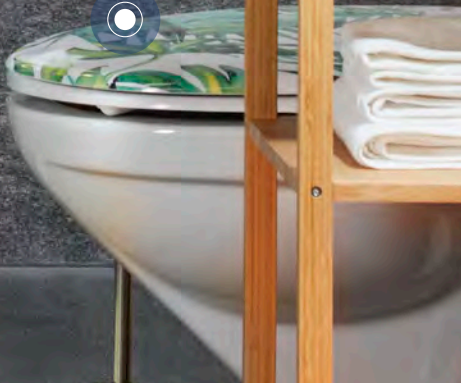
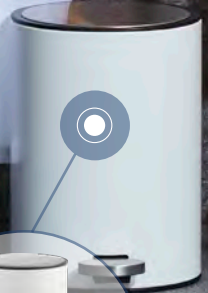



Duschvorhangringe

Anneaux de rideaux de douche

Diverse Designs

Divers designs

Modische Duschvorhangaufhängungen in Ring- oder Hakenform.

Suspensions de rideau de douche modernes en forme d'anneau ou de crochet.

Gängige Form

Form courante

Duschvorhangringe passend zu allen gängigen Duschvorhängen und Duschvorhangstangen.

Anneaux pour rideaux de douche adaptés à toutes les rideaux de douche et tringles à rideaux de douche.

Duschvorhangstangen

Barres de rideaux de douche

Breite Auswahl

Large choix

Diverse Duschvorhangstangen für individuelle Einbausituationen, erhältlich in chrom und weiss.

Différentes barres à rideaux adaptées à chaque configuration d'installation, disponibles en chrome ou en blanc.

Duschvorhangstangen Basic

Barres de rideaux de douche Basic

Die robusten Duschvorhangstangen aus Aluminium sind stufenlos verstellbar und können ohne Bohren durch Federkraft montiert werden.

Les barres de rideaux de douche robustes en aluminium sont réglables en continu et peuvent être montées par ressort, sans percer de trous.

Duschvorhangstange Basic Universal

Barre de rideau de douche Basic Universal

Die Duschvorhangstange Basic Universal kann in 3 verschiedenen Formen und Grössen zusammengesetzt werden. Wird via Bohren befestigt und hält dank einer Deckenhalterung. Die Deckenhalterung ist separat erhältlich.

La barre de rideau de douche Basic Universal peut être assemblée en 3 formes et tailles différentes. Elle se fixe en perçant et tient grâce à un support de plafond. Le support de plafond est disponible séparément.

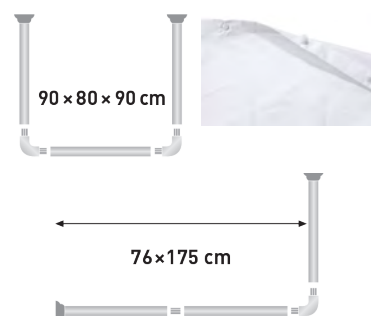

Duschvorhangschienen Special

Rails de rideaux de douche Special



Dank der integrierten Gleiter kann der Duschvorhang ganz einfach an der Schiene befestigt werden.

Grazie alle guide integrate, la tenda della doccia può essere facilmente fissata al binario.

Duschvorhangschienen Special L-Form

Rails de rideaux de douche Special forme de L

Durch die L-Form können die Duschvorhangschienen ums Eck an zwei verschiedenen Wänden befestigt werden. Erhältlich in den Grössen 90 x 90 cm und 75 x 170 cm. Wird via Bohren befestigt und hält dank einer Deckenhalterung. Die Deckenhalterung ist separat erhältlich.

Grâce à la forme en L, les rails de rideau de douche peuvent être fixés en angle sur deux murs différents. Disponible dans les dimensions 90 x 90 cm et 75 x 170 cm. Elle se fixe en perçant et tient grâce à un support de plafond. Le support de plafond est disponible séparément.







Duschvorhangstange

Barre rideau de douche

| EAN-Nr. no EAN | Artikel Nr. no d'article | Beschreibung description | VPE ce | VE ue | UVP pro Stk. PVC CHF excl. | UVP pro Stk. PVC CHF incl. |
|-------------------|-----------------------------|-----------------------------|-----------|----------|----------------------------------|----------------------------------|
|-------------------|-----------------------------|-----------------------------|-----------|----------|----------------------------------|----------------------------------|

Duschvorhangschiene Special Rail de rideau douche Special



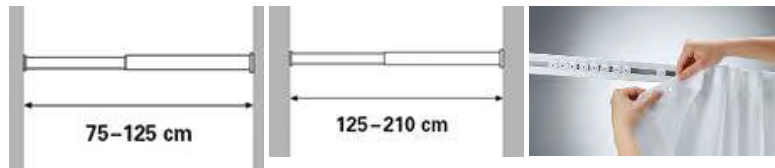

| | | | | | | |
|--|-------------------|--------------------------------|---|---|--------------|--------------|
|  7 611038 247041 | 81 6010 01 | weiss blanc 75-125 cm | 1 |  | 55.92 | 60.22 |
|  7 611038 247058 | 81 6010 02 | weiss blanc 125 - 210 cm | 1 |  | 76.42 | 82.30 |

- Hält durch Federkraft
- Bohrlose Befestigung ohne Werkzeug
- Stufenlos verstellbar
- Aluminium
- Inkl. 12 Gleiter zum Einklicken des Duschvorhangs
- Immobilisation par ressort
- Fixation sans perçage ni outils
- Ajustable
- Aluminium
- 12 patins à encliqueter sur le rideau de douche compris



Duschvorhangschiene Special Rail de rideau douche Special





| | | | | | | |
|---|-------------------|--------------------------------------|---|--|--------------|---------------|
|  7 611038 247065 | 81 6010 03 | weiss, Winkel blanc 90 x 90 cm | 1 |  | 98.79 | 106.39 |
|---|-------------------|--------------------------------------|---|--|--------------|---------------|

- L-förmig 90x90 cm
- Aluminium
- Inkl. Befestigungsmaterial
- Inkl. 12 Gleiter zum Einklicken des Duschvorhangs
- En L 90 x 90 cm
- Aluminium
- Éléments de fixation compris
- 12 patins à encliqueter sur le rideau de douche compris



Duschvorhangschiene Special Rail de rideau douche Special



| | | | | | | |
|--|-------------------|---------------------------------------|---|---|---------------|---------------|
|  7 611038 247072 | 81 6010 04 | weiss, Winkel blanc 170 x 75 cm | 1 |  | 109.04 | 117.43 |
|--|-------------------|---------------------------------------|---|---|---------------|---------------|

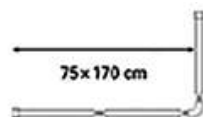

- L-förmig 75x170 cm
- Aluminium
- Inkl. Befestigungsmaterial
- Inkl. 16 Gleiter zum Einklicken des Duschvorhangs
- En L 75 x 170 cm
- Aluminium
- Éléments de fixation compris
- 16 patins à encliqueter sur le rideau de douche compris



Duschvorhangstange



Barre rideau de douche

| EAN-Nr. no EAN | Artikel Nr. no d'article | Beschreibung description | VPE ce | VE ue | UVP pro Stk. PVC CHF excl. | UVP pro Stk. PVC CHF incl. |
|-------------------|-----------------------------|-----------------------------|-----------|----------|----------------------------------|----------------------------------|
|-------------------|-----------------------------|-----------------------------|-----------|----------|----------------------------------|----------------------------------|

| Deckenhalterung für DV-Schiene | | Support plafond barre RD | | | | | |
|---|--|--------------------------|-------------------------|---|---|--------------|--------------|
|  |  7 611038 247089 | 81 6010 05 | weiss blanc 60 cm | 1 |  | 36.35 | 39.14 |

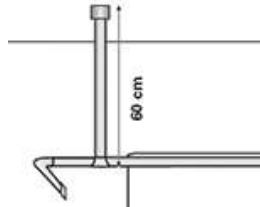
- Optimale Stabilität für gebogene Duschvorhangschienen
- Individuell kürzbar (mittels Eisensäge)
- Aluminium
- *Stabilité optimale pour les rails de rideau de douche cintrés*
- *Peut être au besoin raccourci (à l'aide d'une scie à métaux)*
- Aluminium



| Ersatzgleiter Special Schiene | | Glisseurs de rechange Special | | | | | |
|--|---|-------------------------------|-------------------------------|---|---|-------------|-------------|
|  |  7 611038 247096 | 81 6010 06 | weiss blanc 5 STK / PCS | 1 |  | 5.36 | 5.77 |

Duschvorhangstange

Barre rideau de douche

| EAN-Nr. no EAN | Artikel Nr. no d'article | Beschreibung description | VPE ce | VE ue | UVP pro Stk. PVC CHF excl. | UVP pro Stk. PVC CHF incl. |
|-------------------|-----------------------------|-----------------------------|-----------|----------|----------------------------------|----------------------------------|
|-------------------|-----------------------------|-----------------------------|-----------|----------|----------------------------------|----------------------------------|













NEW

Duschvorhangstange Basic

Barre rideaux de douche Basic



- Hält durch Federkraft
- Bohrlose Befestigung ohne Werkzeug
- Stufenlos verstellbar
- Aluminium
- Immobilisation par ressort
- Fixation sans perçage ni outils
- Ajustable
- Aluminium

| | | | | | | |
|---|-------------------|---|---|---|--------------|--------------|
|  | 81 6000 01 | weiss <i>blanc</i> 75-130 cm ; Ø 21 mm | 1 |  | 16.68 | 17.97 |
|  | 81 6000 02 | chrom <i>chrome</i> 75-130 cm ; Ø 21 mm | 1 |  | 16.68 | 17.97 |
|  | 81 6000 09 | schwarz matt <i>noir</i> 75-130 cm ; Ø 21 mm | 1 |  | 16.68 | 17.97 |
|  | 81 6000 03 | weiss <i>blanc</i> 125-230 cm ; Ø 21 mm | 1 |  | 20.04 | 21.58 |
|  | 81 6000 04 | chrom <i>chrome</i> 125-230 cm ; Ø 21 mm | 1 |  | 20.04 | 21.58 |
|  | 81 6000 10 | schwarz matt <i>noir</i> 125-230 cm ; Ø 21 mm | 1 |  | 20.04 | 21.58 |

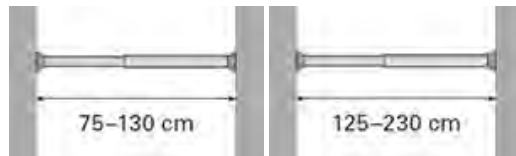
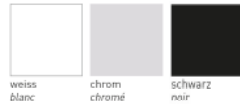



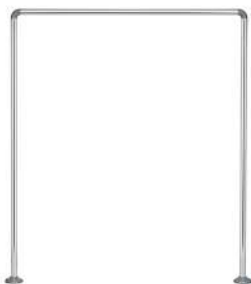

NEW

Duschvorhangstange Basic

Barre rideaux de douche Basic



- U-förmig 90x80x90cm
- L-förmig 90x90cm
- L-förmig 76x175cm
- Aluminium
- En U: 90x80x90cm
- En L: 90x90cm
- EN L: 76x175cm
- Aluminium

| | | | | | | |
|---|-------------------|---|---|---|--------------|--------------|
|  | 81 6000 05 | weiss, Universal <i>blanc</i> 90 x 80 x 90 cm ; Ø 22 mm | 1 |  | 32.15 | 34.63 |
|  | 81 6000 06 | chrom, Universal <i>chrome</i> 90 x 80 x 90 cm ; Ø 22 mm | 1 |  | 32.15 | 34.63 |
|  | 81 6000 11 | schwarz matt, Universal <i>noir</i> 90 x 80 x 90 cm ; Ø 22 mm | 1 |  | 32.15 | 34.63 |

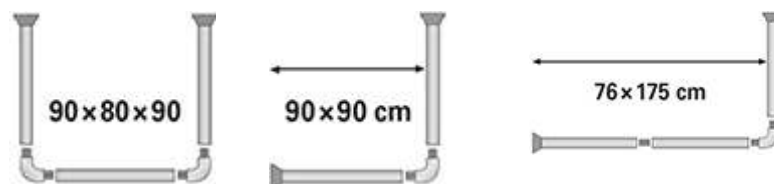
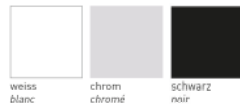

Duschvorhangstange

Barre rideau de douche







| EAN-Nr. no EAN | Artikel Nr. no d'article | Beschreibung description | VPE ce | VE ue | UVP pro Stk. PVC CHF excl. | UVP pro Stk. PVC CHF incl. |
|-------------------|-----------------------------|-----------------------------|-----------|----------|----------------------------------|----------------------------------|
|-------------------|-----------------------------|-----------------------------|-----------|----------|----------------------------------|----------------------------------|

NEW

Deckenhalterung Basic

Support plafond barre RD



| | | | | | | |
|--|-------------------|--|---|---|--------------|--------------|
|  7 611038 246884 | 81 6000 07 | weiss <i>blanc</i> 60 cm ; Ø 22 mm | 1 |  | 14.35 | 15.46 |
|  7 611038 246891 | 81 6000 08 | chrom <i>chrome</i> 60 cm ; Ø 22 mm | 1 |  | 14.35 | 15.46 |
|  7 611038 400309 | 81 6000 12 | schwarz matt <i>noir</i> 60 cm ; Ø 22 mm | 1 |  | 14.35 | 15.46 |

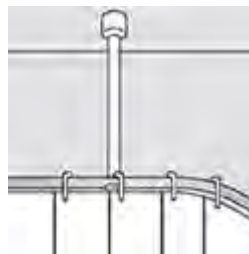
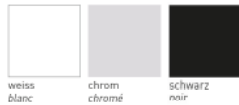

- Optimale Stabilität für gebogene Duschvorhangstange
- Individuell kürzbar (mittels Eisensäge)
- Aluminium
- Stabilité optimale pour les barres rideau de douche cintrés
- Peut être au besoin raccourci (à l'aide d'une scie à métaux)
- Aluminium

Duschvorhangringe Anneaux rideau de douche





| | EAN-Nr. no EAN | Artikel Nr. no d'article | Beschreibung description | VPE ce | VE ue | UVP pro Stk. PVC CHF excl. | UVP pro Stk. PVC CHF incl. |
|--|-------------------|-----------------------------|-----------------------------|-----------|----------|----------------------------------|----------------------------------|
|--|-------------------|-----------------------------|-----------------------------|-----------|----------|----------------------------------|----------------------------------|

NEW

Duschvorhangringe Esra

Anneaux rideau de douche Esra



| | | | | | | |
|---|-------------------|--|---|---|--------------|--------------|
|  | 81 5000 02 | chrom, oval <i>chrom / ovale</i> 7.0 x 4.0 cm ; 12 Stk/pcs | 1 |  | 10.90 | 11.74 |
|  | 81 5000 01 | weiss, oval <i>blanc / ovale</i> 7.0 x 4.0 cm ; 12 STK / PCS | 1 |  | 10.90 | 11.74 |

NEW

Duschvorhangringe Fares

Anneaux rideau de douche Fares





| | | | | | | |
|---|-------------------|---|---|---|--------------|--------------|
|  | 81 5000 03 | chrom, rund <i>chrom / rond</i> Ø 55 mm ; 12 Stk/pcs | 1 |  | 10.90 | 11.74 |
|  | 81 5000 14 | schwarz, rund <i>noir / rond</i> Ø 55 mm ; 12 Stk/pcs | 1 |  | 10.90 | 11.74 |

Duschvorhangringe Yara

Anneaux rideau de douche Yara





| | | | | | | |
|--|-------------------|------------------------------------|---|---|--------------|--------------|
|  | 81 5000 04 | chrom 6.5 x 3.5 cm ; 12 Stk/pcs | 1 |  | 10.90 | 11.74 |
|--|-------------------|------------------------------------|---|---|--------------|--------------|

Duschvorhangringe Leaf

Anneaux rideau de douche Leaf





| | | | | | | |
|---|-------------------|----------------------------------|---|---|--------------|--------------|
|  | 81 5000 05 | chrom 7 x 4.5 cm ; 12 Stk/pcs | 1 |  | 14.26 | 15.36 |
|---|-------------------|----------------------------------|---|---|--------------|--------------|

NEW

Duschvorhangringe Crystal

Anneaux rideau douche Crystal



| | | | | | | |
|---|-------------------|--|---|---|--------------|--------------|
|  | 81 5000 06 | chrom <i>chromé</i> 12 STK / PCS | 1 |  | 13.89 | 14.96 |
|---|-------------------|--|---|---|--------------|--------------|

Duschvorhangringe

Anneaux rideau de douche



| | EAN-Nr. no EAN | Artikel Nr. no d'article | Beschreibung description | VPE ce | VE ue | UVP pro Stk. PVC CHF excl. | UVP pro Stk. PVC CHF incl. |
|--|-------------------|-----------------------------|-----------------------------|-----------|----------|----------------------------------|----------------------------------|
|--|-------------------|-----------------------------|-----------------------------|-----------|----------|----------------------------------|----------------------------------|

NEW

Duschvorhangringe Alpha

Anneaux rideau douche Alpha











| | | | | | | |
|---|-------------------|-----------------------|---|---|--------------|--------------|
|  | 81 5000 07 | chrom 12 STK / PCS | 1 |  | 10.90 | 11.74 |
|---|-------------------|-----------------------|---|---|--------------|--------------|

Duschvorhangringe Basic

Anneaux rideau douche Basic



| | | | | | | |
|--|-------------------|--|---|--|-------------|-------------|
|  | 81 5000 09 | weiss blanc 6 x 4.2 cm ; 12 Stk/pcs | 1 |  | 4.29 | 4.62 |
|  | 81 5000 10 | transparent 6 x 4.2 cm ; 12 Stk/pcs | 1 |  | 4.80 | 5.17 |
|  | 81 5000 12 | schwarz noir 6 x 4.2 cm ; 12 Stk/pcs | 1 |  | 4.80 | 5.17 |
|  | 81 5000 13 | chrom chrome 6 x 4.2 cm ; 12 Stk/pcs | 1 |  | 5.73 | 6.17 |



Duschvorhangringe

Anneaux rideau de douche

| EAN-Nr. <i>no EAN</i> | Artikel Nr. <i>no d'article</i> | Beschreibung <i>description</i> | VPE <i>ce</i> | VE <i>ue</i> | UVP pro Stk. <i>PVC</i> CHF excl. | UVP pro Stk. <i>PVC</i> CHF incl. |
|--------------------------|------------------------------------|------------------------------------|------------------|-----------------|---|---|
|--------------------------|------------------------------------|------------------------------------|------------------|-----------------|---|---|

NEW

Duschvorhang-Klammern

Pinces pour rideau de douche



81 5000 11

weiss
blanc
5 x 4 cm ; 2 Stk/pcs

1



7.13

7.68





Seite / Page
1.8



Seite / Page
4.53



Seite / Page
3.39



Seite / Page
2.23

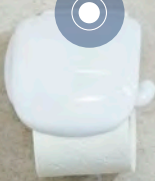

Seite / Page
5.71



Seite / Page
1.68



Seite / Page
1.64



Seite / Page
1.42



Seite / Page
1.71



Seite / Page
2.43

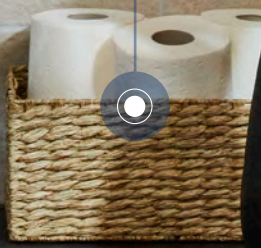



Badezimmerteppiche

Tapis de salle de bains

Materialien

Matériaux



Hergestellt aus hochwertiger Baumwollnatur-, Polyacryl- oder Polyesterfaser.

En fibre de coton naturel, de polyacrylique ou de polyester de haute qualité.

Florhöhe

Hauteur du poil



Die flauschige Florhöhe sorgt für ein Wohlgefühl und Schalldämmung beim Auftreten.

La hauteur du poil moelleux procure une sensation de bien-être et d'insonorisation lorsque l'on marche dessus.

Sicherheit

Sécurité



Rutschhemmende Latexierung auf der Unterseite macht die Teppiche trittsicher.

Revêtement en latex antidérapant sur la face inférieure qui évite de glisser.

Größen

Dimensions

Erhältlich in 2 verschiedenen Größen: 55 x 65 cm und 60 x 90 cm.

Disponibles en deux tailles: 55 x 65 cm et 60 x 90 cm.

Zertifizierung

Certification



Teilweise zertifiziert nach OEKO-TEX® Standard 100.

En partie certifiés conformes à la norme OEKO-TEX® Standard 100.

Frottiervorleger

Tapis en tissu éponge

Materialien

Matériaux

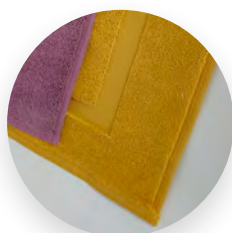

Die feine Frottierschlingenoberfläche hergestellt aus hautfreundlicher Baumwolle macht das Material voluminös und verstärkt die Saugfähigkeit des Baumwollgarns.

La surface lisse de boucles d'éponge en coton hypoallergénique donne plus de volume au matériau et augmente le pouvoir absorbant du fil de coton.

Größen

Dimensions

Erhältlich in der Grösse 50 x 70 cm.

Disponibles dans la taille 50 x 70 cm.

Zertifizierung

Certification

































Zertifiziert nach OEKO-TEX® Standard 100.

Certifiés conformes à la norme OEKO-TEX® Standard 100.

Badteppich

Tapis de bain

| | EAN-Nr. no EAN | Artikel Nr. no d'article | Beschreibung description | VPE ce | VE ue | UVP pro Stk. PVC CHF excl. | UVP pro Stk. PVC CHF incl. |
|---|---|-----------------------------|---|-----------|---|----------------------------------|----------------------------------|
|  |  | 81 4000 37 | weiss <i>blanc</i> 55 x 65 cm ; 20 mm | 1 |  | 43.34 | 46.67 |
| |  | 81 4000 38 | weiss <i>blanc</i> 60 x 90 cm ; 20 mm | 1 |  | 55.92 | 60.22 |
|  |  | 81 4000 40 | taupe 55 x 65 cm ; 20 mm | 1 |  | 43.34 | 46.67 |
| |  | 81 4000 41 | taupe 60 x 90 cm ; 20 mm | 1 |  | 55.92 | 60.22 |
|  |  | 81 4000 43 | anthrazit 55 x 65 cm ; 20 mm | 1 |  | 43.34 | 46.67 |
| |  | 81 4000 44 | anthrazit 60 x 90 cm ; 20 mm | 1 |  | 55.92 | 60.22 |
|  |  | 81 4000 74 | mint 55 x 65 cm ; 20 mm | 1 |  | 43.34 | 46.67 |
| |  | 81 4000 75 | mint 60 x 90 cm ; 20 mm | 1 |  | 55.92 | 60.22 |
|  |  | 81 4000 77 | powder 55 x 65 cm ; 20 mm | 1 |  | 43.34 | 46.67 |
| |  | 81 4000 78 | powder 60 x 90 cm ; 20 mm | 1 |  | 55.92 | 60.22 |
|  |  | 81 4000 80 | natura 55 x 65 cm ; 20 mm | 1 |  | 43.34 | 46.67 |
| |  | 81 4000 81 | natura 60 x 90 cm ; 20 mm | 1 |  | 55.92 | 60.22 |

100% Polyacryl
100% polyacrilique























OEKO-TEX®
CONFIDENCE IN TEXTILES
STANDARD 100
10.HIN.82391 HOHENSTEIN HTTI
Tested for harmful substances.
www.oeko-tex.com/standard100

Badteppich











Tapis de bain

| EAN-Nr. no EAN | Artikel Nr. no d'article | Beschreibung description | VPE ce | VE ue | UVP pro Stk. PVC CHF excl. | UVP pro Stk. PVC CHF incl. |
|-------------------|-----------------------------|-----------------------------|-----------|----------|----------------------------------|----------------------------------|
|-------------------|-----------------------------|-----------------------------|-----------|----------|----------------------------------|----------------------------------|

| Badteppich Tilo | | Tapis de Bain Tilo | | | | | |
|---|---|--------------------|---|---|---|--------------|--------------|
|  |  | 81 4000 52 | türkis turquoise 55 x 65 cm ; 20 mm | 1 |  | 43.34 | 46.67 |
| |  | 81 4000 53 | türkis turquoise 60 x 90 cm ; 20 mm | 1 |  | 55.92 | 60.22 |
|  |  | 81 4000 55 | rot rouge 55 x 65 cm ; 20 mm | 1 |  | 43.34 | 46.67 |
| |  | 81 4000 56 | rot rouge 60 x 90 cm ; 20 mm | 1 |  | 55.92 | 60.22 |
|  |  | 81 4000 58 | schwarz noir 55 x 65 cm ; 20 mm | 1 |  | 43.34 | 46.67 |
| |  | 81 4000 59 | schwarz noir 60 x 90 cm ; 20 mm | 1 |  | 55.92 | 60.22 |
|  |  | 81 4000 71 | blau bleu 55 x 65 cm ; 20 mm | 1 |  | 43.34 | 46.67 |
| |  | 81 4000 72 | blau bleu 60 x 90 cm ; 20 mm | 1 |  | 55.92 | 60.22 |

100% Polyacryl
100% polyacrilique



| Badteppich Mezzo | | Tapis de Bain Mezzo | | | | | |
|---|---|---------------------|------------------------------|---|---|--------------|--------------|
|  |  | 81 4000 25 | kiwi 55 x 65 cm ; 25 mm | 1 |  | 55.92 | 60.22 |
| |  | 81 4000 26 | kiwi 60 x 90 cm ; 25 mm | 1 |  | 66.17 | 71.26 |
|  |  | 81 4000 28 | marine 55 x 65 cm ; 25 mm | 1 |  | 55.92 | 60.22 |
| |  | 81 4000 29 | marine 60 x 90 cm ; 25 mm | 1 |  | 66.17 | 71.26 |

100% Polyacryl
100% polyacrilique







Badteppich

Tapis de bain

| | EAN-Nr. <i>no EAN</i> | Artikel Nr. <i>no d'article</i> | Beschreibung <i>description</i> | VPE <i>ce</i> | VE <i>ue</i> | UVP pro Stk. <i>PVC</i> CHF excl. | UVP pro Stk. <i>PVC</i> CHF incl. |
|--|--------------------------|------------------------------------|------------------------------------|------------------|-----------------|---|---|
|--|--------------------------|------------------------------------|------------------------------------|------------------|-----------------|---|---|

Badteppich Step Tapis de Bain Step



| | | | | | | |
|---|-------------------|---|---|---|--------------|--------------|
|  | 81 4000 31 | beige 55 x 65 cm ; 25 mm | 1 |  | 55.92 | 60.22 |
|  | 81 4000 32 | beige 60 x 90 cm ; 25 mm | 1 |  | 66.17 | 71.26 |
|  | 81 4000 34 | grau <i>gris</i> 55 x 65 cm ; 25 mm | 1 |  | 55.92 | 60.22 |
|  | 81 4000 35 | grau <i>gris</i> 60 x 90 cm ; 25 mm | 1 |  | 66.17 | 71.26 |

100% Polyacryl
100% polyacrilique



Badteppich Network Tapis de Bain Network

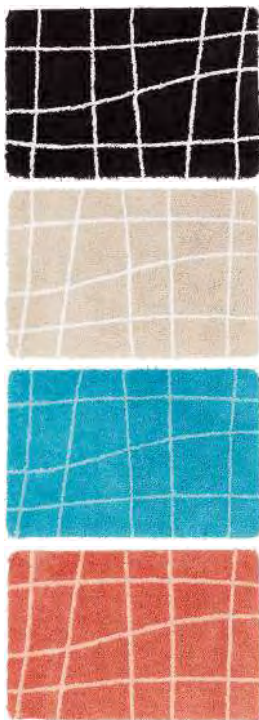













| | | | | | | |
|---|-------------------|--|---|---|--------------|--------------|
|  | 81 4010 01 | schwarz <i>noir</i> 55 x 65 cm ; 20 mm | 1 |  | 28.89 | 31.12 |
|  | 81 4010 02 | schwarz <i>noir</i> 60 x 90 cm ; 20 mm | 1 |  | 39.61 | 42.66 |
|  | 81 4010 04 | natur 55 x 65 cm ; 20 mm | 1 |  | 28.89 | 31.12 |
|  | 81 4010 05 | natur 60 x 90 cm ; 20 mm | 1 |  | 39.61 | 42.66 |
|  | 81 4010 07 | aqua 55 x 65 cm ; 20 mm | 1 |  | 28.89 | 31.12 |
|  | 81 4010 08 | aqua 60 x 90 cm ; 20 mm | 1 |  | 39.61 | 42.66 |
|  | 81 4010 10 | peach 55 x 65 cm ; 20 mm | 1 |  | 28.89 | 31.12 |
|  | 81 4010 11 | peach 60 x 90 cm ; 20 mm | 1 |  | 39.61 | 42.66 |

100% Polyester

Badteppich







Tapis de bain

| | EAN-Nr. no EAN | Artikel Nr. no d'article | Beschreibung description | VPE ce | VE ue | UVP pro Stk. PVC CHF excl. | UVP pro Stk. PVC CHF incl. |
|--|-------------------|-----------------------------|-----------------------------|-----------|----------|----------------------------------|----------------------------------|
|--|-------------------|-----------------------------|-----------------------------|-----------|----------|----------------------------------|----------------------------------|

| Badteppich Duo | | Tapis de Bain Duo | | | | | |
|--|---|-------------------|------------------------------------|---|---|--------------|--------------|
|  |  | 81 4010 13 | grau gris 55 x 65 cm ; 20 mm | 1 |  | 28.89 | 31.12 |
| |  | 81 4010 14 | grau gris 60 x 90 cm ; 20 mm | 1 |  | 39.61 | 42.66 |
| |  | 81 4010 16 | mint 55 x 65 cm ; 20 mm | 1 |  | 28.89 | 31.12 |
| |  | 81 4010 17 | mint 60 x 90 cm ; 20 mm | 1 |  | 39.61 | 42.66 |
| |  | 81 4010 19 | natura 55 x 65 cm ; 20 mm | 1 |  | 28.89 | 31.12 |
| |  | 81 4010 20 | natura 60 x 90 cm ; 20 mm | 1 |  | 39.61 | 42.66 |

100% Polyester

NEW

| Badteppich Comfy | | Tapis de Bain Comfy | | | | | |
|---|---|---------------------|--------------------------------------|---|---|--------------|--------------|
|  |  | 81 4010 23 | weiss blanc 60 x 90 cm ; 20 mm | 1 |  | 26.05 | 28.05 |
| |  | 81 4010 26 | beige 60 x 90 cm ; 20 mm | 1 |  | 26.05 | 28.05 |
| |  | 81 4010 29 | aqua 60 x 90 cm ; 20 mm | 1 |  | 26.05 | 28.05 |





















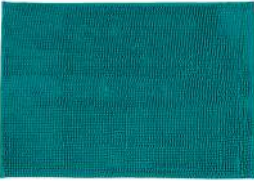





Hergestellt aus 100% recycelten
PET Flaschen
Fabriqué en 100% bouteilles PET
recyclées



Badteppich

Tapis de bain





















| | EAN-Nr. no EAN | Artikel Nr. no d'article | Beschreibung description | VPE ce | VE ue | UVP pro Stk. PVC CHF excl. | UVP pro Stk. PVC CHF incl. |
|---|---|-----------------------------|--|-----------|---|----------------------------------|----------------------------------|
| Badteppich Shania | | Tapis de Bain Shania | | | | | |
|  |  7 611038 185886 | 81 4020 01 | gelb <i>jaune</i> 55 x 65 cm ; 15 mm | 1 |  | 21.90 | 23.59 |
| |  7 611038 185893 | 81 4020 02 | gelb <i>jaune</i> 60 x 90 cm ; 15 mm | 1 |  | 32.62 | 35.13 |
|  |  7 611038 185916 | 81 4020 04 | rot <i>rouge</i> 55 x 65 cm ; 15 mm | 1 |  | 21.90 | 23.59 |
| |  7 611038 185923 | 81 4020 05 | rot <i>rouge</i> 60 x 90 cm ; 15 mm | 1 |  | 32.62 | 35.13 |
|  |  7 611038 185947 | 81 4020 07 | grün <i>vert</i> 55 x 65 cm ; 15 mm | 1 |  | 21.90 | 23.59 |
| |  7 611038 185954 | 81 4020 08 | grün <i>vert</i> 60 x 90 cm ; 15 mm | 1 |  | 32.62 | 35.13 |
|  |  7 611038 185978 | 81 4020 10 | blau <i>bleu</i> 55 x 65 cm ; 15 mm | 1 |  | 21.90 | 23.59 |
| |  7 611038 185985 | 81 4020 11 | blau <i>bleu</i> 60 x 90 cm ; 15 mm | 1 |  | 32.62 | 35.13 |
|  |  7 611038 186005 | 81 4020 13 | anthrazit 55 x 65 cm ; 15 mm | 1 |  | 21.90 | 23.59 |
| |  7 611038 186012 | 81 4020 14 | anthrazit 60 x 90 cm ; 15 mm | 1 |  | 32.62 | 35.13 |

100% Chenille Polyester

Badteppich

Tapis de bain

| EAN-Nr. no EAN | Artikel Nr. no d'article | Beschreibung description | VPE ce | VE ue | UVP pro Stk. PVC CHF excl. | UVP pro Stk. PVC CHF incl. |
|-------------------|-----------------------------|-----------------------------|-----------|----------|----------------------------------|----------------------------------|
|-------------------|-----------------------------|-----------------------------|-----------|----------|----------------------------------|----------------------------------|

| Badteppich Waffle | | Tapis de Bain Waffle | | | | | |
|--|---|----------------------|---|---|---|--------------|--------------|
|  |  | 81 3000 13 | weiss <i>blanc</i> 55 x 65 cm ; 20 mm | 1 |  | 41.47 | 44.67 |
| |  | 81 3000 14 | weiss <i>blanc</i> 60 x 90 cm ; 20 mm | 1 |  | 52.19 | 56.21 |
|  |  | 81 3000 16 | sand <i>sable</i> 55 x 65 cm ; 20 mm | 1 |  | 41.47 | 44.67 |
| |  | 81 3000 17 | sand <i>sable</i> 60 x 90 cm ; 20 mm | 1 |  | 52.19 | 56.21 |
|  |  | 81 3000 25 | grau <i>gris</i> 55 x 65 cm ; 20 mm | 1 |  | 41.47 | 44.67 |
| |  | 81 3000 26 | grau <i>gris</i> 60 x 90 cm ; 20 mm | 1 |  | 52.19 | 56.21 |
|  |  | 81 3000 28 | arctic 55 x 65 cm ; 20 mm | 1 |  | 41.47 | 44.67 |
| |  | 81 3000 29 | arctic 60 x 90 cm ; 20 mm | 1 |  | 52.19 | 56.21 |

100% Baumwolle
100% Coton



Badteppich









Tapis de bain

| EAN-Nr. no EAN | Artikel Nr. no d'article | Beschreibung description | VPE ce | VE ue | UVP pro Stk. PVC CHF excl. | UVP pro Stk. PVC CHF incl. |
|-------------------|-----------------------------|-----------------------------|-----------|----------|----------------------------------|----------------------------------|
|-------------------|-----------------------------|-----------------------------|-----------|----------|----------------------------------|----------------------------------|

NEW

Badteppich Kayla

Tapis de Bain Kayla

| | | | | | | |
|---|--|---|---|---|--------------|--------------|
|  |  7 611038 387761 | 81 3000 32 jade 60 x 90 cm ; 1.5 mm | 1 |  | 37.23 | 40.10 |
|  |  7 611038 387778 | 81 3000 35 beige 60 x 90 cm ; 1.5 mm | 1 |  | 37.23 | 40.10 |
|  |  7 611038 387877 | 81 3000 38 white 60 x 90 cm ; 1.5 mm | 1 |  | 37.23 | 40.10 |



100% recycelte Baumwolle
100% Coton recyclé

Frottiervorleger

Tapis en tissu éponge

| EAN-Nr. no EAN | Artikel Nr. no d'article | Beschreibung description | VPE ce | VE ue | UVP pro Stk. PVC CHF excl. | UVP pro Stk. PVC CHF incl. |
|-------------------|-----------------------------|-----------------------------|-----------|----------|----------------------------------|----------------------------------|
|-------------------|-----------------------------|-----------------------------|-----------|----------|----------------------------------|----------------------------------|

Frottiervorleger Fresco Tapis en tissu éponge Fresco

| | | | | | | |
|---|--|--|---|---|--------------|--------------|
|  |  7 611038 184025 | 81 2000 57 dunkelgrau, 100% Baumwolle <i>gris foncé</i> ~ 50 x 70 cm | 2 |  | 20.50 | 22.08 |
| |  7 611038 184018 | 81 2000 41 weiss, 100% Baumwolle <i>blanc</i> ~ 50 x 70 cm | 2 |  | 20.50 | 22.08 |
|  |  7 611038 478513 | 81 2000 38 mauve, 100% Baumwolle <i>mauve</i> ~ 50 x 70 cm | 2 |  | 20.50 | 22.08 |
| |  7 611038 184124 | 81 2000 45 taupe, 100% Baumwolle <i>taupe</i> ~ 50 x 70 cm | 2 |  | 20.50 | 22.08 |
| |  7 611038 478544 | 81 2000 40 safran, 100% Baumwolle <i>safran</i> ~ 50 x 70 cm | 2 |  | 20.50 | 22.08 |
|  |  7 611038 478520 | 81 2000 37 dunkelblau, 100% Baumwolle <i>bleu foncé</i> ~ 50 x 70 cm | 2 |  | 20.50 | 22.08 |
| |  7 611038 478537 | 81 2000 39 petrol, 100% Baumwolle <i>petrol</i> ~ 50 x 70 cm | 2 |  | 20.50 | 22.08 |
|  |  7 611038 478551 | 81 2000 35 salbei, 100% Baumwolle <i>sage</i> ~ 50 x 70 cm | 2 |  | 20.50 | 22.08 |
|  | | | | | | |
| | |  | | | | |
| | |  | | | | |
| | |  | | | | |

OEKO-TEX®
CONFIDENCE IN TEXTILES
STANDARD 100
1801005 Centexbel
Tested for harmful substances.
www.oeko-tex.com/standard100

100% Baumwolle
100% coton

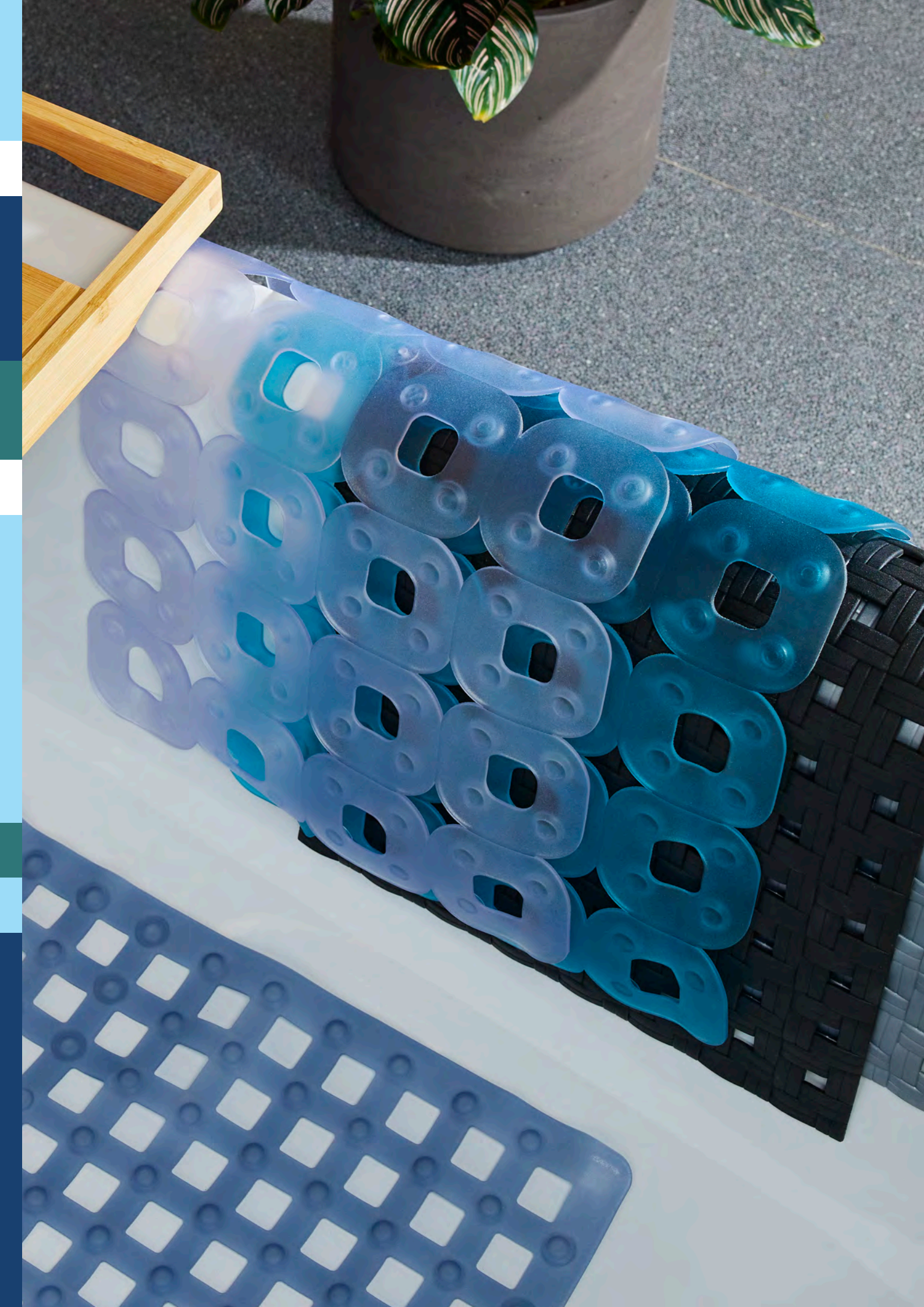

Wanneneinlagen

Tapis de bain antidérapants

Größen

Dimensions

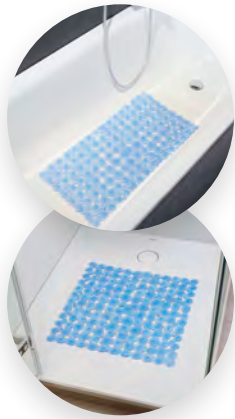

Jedes Design erhältlich für die Dusche und für die Badewanne.

Chaque modèle disponible pour la douche et pour la baignoire.

Material

Matériaux



Bestehend zu 100% aus Polyvinylchlorid (PVC) und frei von Phtalaten sowie schädlichen Weichmachern, Farbstoffen und Schwermetallen.

Composés à 100% de chlorure de polyvinyle (PVC), sans phtalates et sans plastifiants, colorants ou métaux lourds nocifs.

Sicherheit

Sécurité



Aufgeraute Oberfläche und exzellente Saugnäpfe sorgen für hohe Trittsicherheit und gute Haftung des Produkts in der Dusche und Wanne.

La surface rugueuse et les ventouses efficaces garantissent de bonnes propriétés antidérapantes et une bonne adhérence du produit dans la douche et la baignoire.

Nackenkissen

Coussin pour baignoire











Nackenkissen für Badewanne in verschiedenen Versionen verfügbar.

Coussin pour baignoire disponible en différentes versions.





Wanneneinlagen

Tapis de bain antidérapants

| | EAN-Nr. no EAN | Artikel Nr. no d'article | Beschreibung description | VPE ce | VE ue | UVP pro Stk. PVC CHF excl. | UVP pro Stk. PVC CHF incl. |
|---|---|---------------------------------------|---|-----------|---|----------------------------------|----------------------------------|
| Badewanneneinlage Smoothie | | Tap. bain antidérapant Smoothi | | | | | |
|  |  | 81 1000 13 | weiss <i>blanc</i> ~ 35 x 71 cm | 1 |  | 26.09 | 28.10 |
| |  | 81 1000 14 | weiss <i>blanc</i> ~ 54.5 x 54.5 cm | 1 |  | 26.09 | 28.10 |
| |  | 81 1000 15 | grau <i>gris</i> ~ 35 x 71 cm | 1 |  | 26.09 | 28.10 |
| |  | 81 1000 16 | grau <i>gris</i> ~ 54.5 x 54.5 cm | 1 |  | 26.09 | 28.10 |





100% PVC



| | | | | | | | |
|--|---|--------------------------------------|--------------------------|---|---|--------------|--------------|
| Badewanneneinlage Smoothie | | Tap. bain antidérap. Smoothie | | | | | |
|  |  | 81 1000 20 | Mare ~ 35 x 71 cm | 1 |  | 21.43 | 23.09 |
| |  | 81 1000 21 | Mare ~ 54.5 x 54.5 cm | 1 |  | 31.22 | 33.62 |





100% PVC



| | | | | | | | |
|---|---|--------------------------------------|------------------------------|---|---|--------------|--------------|
| Badewanneneinlage Smoothie | | Tap. bain antidérap. Smoothie | | | | | |
|  |  | 81 1000 22 | Flamingo ~ 35 x 71 cm | 1 |  | 31.22 | 33.62 |
| |  | 81 1000 23 | Flamingo ~ 54.5 x 54.5 cm | 1 |  | 31.22 | 33.62 |

100% PVC



| | | | | | | | |
|---|---|--------------------------------------|----------------------------|---|---|--------------|--------------|
| Badewanneneinlage Smoothie | | Tap. bain antidérap. Smoothie | | | | | |
|  |  | 81 1000 24 | Bamboo ~ 35 x 71 cm | 1 |  | 31.22 | 33.62 |
| |  | 81 1000 25 | Bamboo ~ 54.5 x 54.5 cm | 1 |  | 31.22 | 33.62 |

100% PVC



Wanneneinlagen

Tapis de bain antidérapants

| | EAN-Nr. no EAN | Artikel Nr. no d'article | Beschreibung description | VPE ce | VE ue | UVP pro Stk. PVC CHF excl. | UVP pro Stk. PVC CHF incl. |
|--|-------------------|-----------------------------|-----------------------------|-----------|----------|----------------------------------|----------------------------------|
|--|-------------------|-----------------------------|-----------------------------|-----------|----------|----------------------------------|----------------------------------|

Badewanneneinlage Smoothie

Tap. bain antidérap. Smoothie



81 1000 26

City
~ 35 x 71 cm

1



31.22

33.62



81 1000 27

City
~ 54.5 x 54.5 cm

1



31.22

33.62

100% PVC



Nackenkissen Smoothie

Coussin p. baignoire Smoothie



81 1100 01

weiss
blanc
~ 32 x 23 cm

1



15.56

16.76



81 1100 02

grau
gris
~ 32 x 23 cm

1



15.56

16.76

100% PVC



Nackenkissen Smoothie

Coussin p. baignoire Smoothie



81 1100 03

Mare
~ 32 x 23 cm

1



18.64

20.07

100% PVC













Wanneneinlagen

Tapis de bain antidérapants

| | EAN-Nr. no EAN | Artikel Nr. no d'article | Beschreibung description | VPE ce | VE ue | UVP pro Stk. PVC CHF excl. | UVP pro Stk. PVC CHF incl. |
|--|-------------------|-----------------------------|-----------------------------|-----------|----------|----------------------------------|----------------------------------|
|--|-------------------|-----------------------------|-----------------------------|-----------|----------|----------------------------------|----------------------------------|

Badewanneneinlage Mesh

Tapis bain antidérapant Mesh

| | | | | | | | |
|---|--|-------------------|--|---|---|--------------|--------------|
|  |  7 611038 176105 | 81 1000 18 | weiss <i>blanc</i> ~ 36 x 71 cm | 1 |  | 29.36 | 31.62 |
| |  7 611038 176112 | 81 1000 19 | weiss <i>blanc</i> ~ 55 x 55 cm | 1 |  | 29.36 | 31.62 |
|  |  7 611038 246624 | 81 1000 07 | hellblau <i>bleu claire</i> ~ 36 x 71 cm | 1 |  | 29.36 | 31.62 |
| |  7 611038 246631 | 81 1000 08 | hellblau <i>bleu claire</i> ~ 55 x 55 cm | 1 |  | 29.36 | 31.62 |

100% PVC



Badewanneneinlage Basky

Tapis bain antidérapant Basky

| | | | | | | | |
|---|--|-------------------|---|---|---|--------------|--------------|
|  |  7 611038 246587 | 81 1000 01 | silber <i>argent</i> ~ 35.5 x 70 cm | 1 |  | 29.36 | 31.62 |
| |  7 611038 246594 | 81 1000 02 | silber <i>argent</i> ~ 54 x 52 cm | 1 |  | 29.36 | 31.62 |
|  |  7 611038 246693 | 81 1000 03 | schwarz <i>noir</i> ~ 35.5 x 70 cm | 1 |  | 29.36 | 31.62 |
| |  7 611038 246709 | 81 1000 04 | schwarz <i>noir</i> ~ 54 x 52 cm | 1 |  | 29.36 | 31.62 |

100% PVC



Wanneneinlagen

Tapis de bain antidérapants

| | EAN-Nr. no EAN | Artikel Nr. no d'article | Beschreibung description | VPE ce | VE ue | UVP pro Stk. PVC CHF excl. | UVP pro Stk. PVC CHF incl. |
|--|-------------------|-----------------------------|-----------------------------|-----------|----------|----------------------------------|----------------------------------|
|--|-------------------|-----------------------------|-----------------------------|-----------|----------|----------------------------------|----------------------------------|

Badewanneneinlage Paco

Tapis bain antidérapant Paco

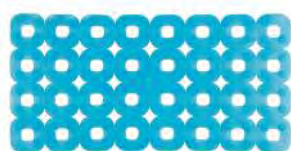

81 1000 09

aqua
~ 35 x 71 cm

1



23.76

25.59



81 1000 10

aqua
~ 53 x 53 cm

1



23.76

25.59



81 1000 11

transparent
transparente
~ 35 x 71 cm

1



23.76

25.59



81 1000 12

transparent
transparente
~ 53 x 53 cm

1



23.76

25.59

100% PVC



Badewanneneinlage Sasso

Tapis bain antidérapant Sasso



81 1000 32

weiss
blanc
~ 36 x 71 cm

1



23.76

25.59



81 1000 33

weiss
blanc
~ 53 x 53 cm

1



23.76

25.59



81 1000 34

transparent
~ 36 x 71 cm

1



23.76

25.59



81 1000 35

transparent
~ 53 x 53 cm

1



23.76











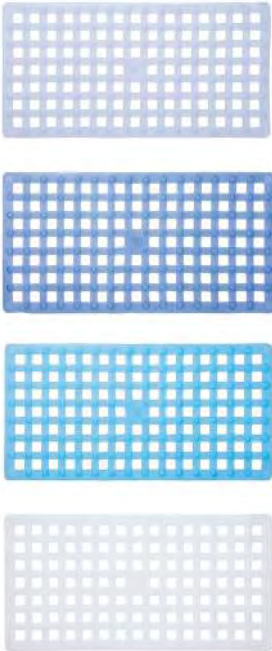





25.59

100% PVC









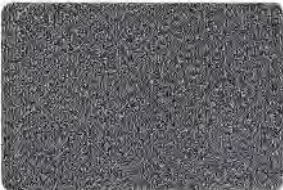

Wanneneinlagen

Tapis de bain antidérapants

| | EAN-Nr. no EAN | Artikel Nr. no d'article | Beschreibung description | VPE ce | VE ue | UVP pro Stk. PVC CHF excl. | UVP pro Stk. PVC CHF incl. |
|--|---|---------------------------------------|---|-----------|---|----------------------------------|----------------------------------|
| Badewanneneinlage Square | | Tapis bain antidérapant Square | | | | | |
|  |  | 81 1000 36 | transparent ~ 34.5 x 69.5 cm | 1 |  | 15.56 | 16.76 |
| |  | 81 1000 37 | transparent ~ 53 x 53 cm | 1 |  | 15.56 | 16.76 |
| |  | 81 1000 38 | indigo ~ 34.5 x 69.5 cm | 1 |  | 15.56 | 16.76 |
| |  | 81 1000 39 | indigo ~ 53 x 53 cm | 1 |  | 15.56 | 16.76 |
| |  | 81 1000 40 | aqua ~ 34.5 x 69.5 cm | 1 |  | 15.56 | 16.76 |
| |  | 81 1000 41 | aqua ~ 53 x 53 cm | 1 |  | 15.56 | 16.76 |
| 100% PVC |  | 81 1000 42 | weiss <i>blanc</i> ~ 34.5 x 69.5 cm | 1 |  | 15.56 | 16.76 |
| |  | 81 1000 43 | weiss <i>blanc</i> ~ 53 x 53 cm | 1 |  | 15.56 | 16.76 |



| | Duschmatte Noodles | | Tapis de douche Noodles | | | | |
|---|---|-------------------|--|---|---|--------------|--------------|
|  |  | 81 1001 01 | weiss <i>blanc</i> 40 x 60 cm | 1 |  | 20.50 | 22.08 |
| |  | 81 1001 02 | schwarz <i>noir</i> 40 x 60 cm | 1 |  | 20.50 | 22.08 |
| |  | 81 1001 03 | schwarz / weiss <i>noir / blanc</i> 40 x 60 cm | 1 |  | 20.50 | 22.08 |
| |  | 81 1001 04 | blau <i>bleu</i> 40 x 60 cm | 1 |  | 20.50 | 22.08 |



Wanneneinlagen

Tapis de bain antidérapants

| EAN-Nr. no EAN | Artikel Nr. no d'article | Beschreibung description | VPE ce | VE ue | UVP pro Stk. PVC CHF excl. | UVP pro Stk. PVC CHF incl. |
|-------------------|-----------------------------|-----------------------------|-----------|----------|----------------------------------|----------------------------------|
|-------------------|-----------------------------|-----------------------------|-----------|----------|----------------------------------|----------------------------------|

Wanneneinlage Minis Tapis bain antidérapant Minis



81 1200 01

Duckie
11.5 x 11.5 cm ; 5 Stk/pcs

1



12.39

13.35

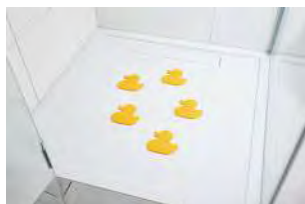

100% PVC

Wanneneinlage Minis Tapis bain antidérapant Minis



81 1200 02

Fish
13 x 8.6 cm ; 5 Stk/pcs

1



12.39

13.35



100% PVC

Wanneneinlage Minis Tapis bain antidérapant Minis



81 1200 03

Love
11.5 x 13 cm ; 5 Stk/pcs

1



12.39

13.35

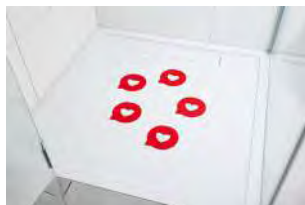

100% PVC

Wanneneinlage Minis Tapis bain antidérapant Minis



81 1200 05

Smile
Ø 11.5 cm ; 5 Stk/pcs

1



12.39

13.35



100% PVC

Wanneneinlagen

Tapis de bain antidérapants

| EAN-Nr. no EAN | Artikel Nr. no d'article | Beschreibung description | VPE ce | VE ue | UVP pro Stk. PVC CHF excl. | UVP pro Stk. PVC CHF incl. |
|-------------------|-----------------------------|-----------------------------|-----------|----------|----------------------------------|----------------------------------|
|-------------------|-----------------------------|-----------------------------|-----------|----------|----------------------------------|----------------------------------|

Wanneneinlage Minis Tapis bain antidérapant Minis



81 1200 04

Shell
11 x 11.5 cm ; 5 Stk/pcs

1



12.39

13.35



100% PVC

Wanneneinlage Minis Tapis bain antidérapant Minis



81 1200 06

Starfish
12 x 10 cm ; 5 Stk/pcs

1



12.39

13.35

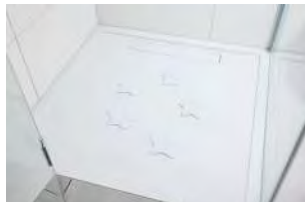

100% PVC

Antirutsch Streifen Bandes antidérapants



87 9999 98

transparent
2 x 38 cm ; 9 Stk/pcs

1



10.81

11.64



Fester Stand beim
Duschen dank
rutschhemmender
Oberfläche
*Surface rugueuse
empêchant de glisser dans
la douche*



Wasserabweisend
Déperlantes



Selbstklebend / Ablösbar
Autocollant / Amovible

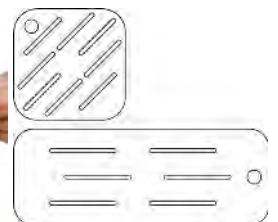

Ausreichend für eine
Bade- oder Duschwanne
*Suffisant pour une baignoire
ou un receveur de douche*



Seite / Page
1.19



Seite / Page
4.54



Seite / Page
2.23



Seite / Page
2.23



Seite / Page
1.62



Seite / Page
5.82



Seite / Page
1.69



Seite / Page
1.68



Seite / Page
1.42



Seite / Page
2.22



Seite / Page
4.19

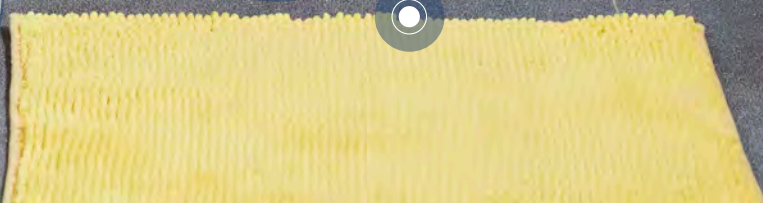
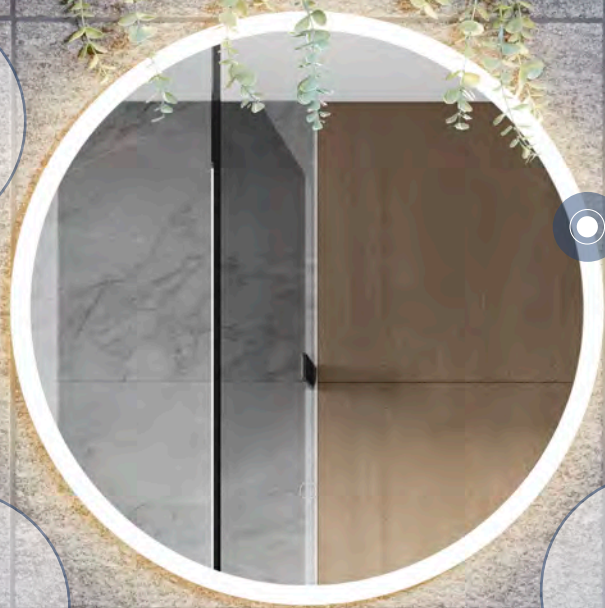



Aufbewahrungskörbe

Paniers

100% Polyester

100% polyester



Polyester ist pflegeleicht und resistent gegen Feuchtigkeit, deshalb sind die Produkte aus 100% Polyester ideal für dein Badezimmer.



Le polyester est facile à entretenir et résiste à l'humidité, c'est pourquoi les produits 100% polyester sont idéaux pour ta salle de bains.

100% Polypropylen

100% polypropylène



Diese Produkte bestehen zu 100% aus robustem Polypropylen und bringen Ordnung in dein Badezimmer.



Ces produits sont composés à 100% de polypropylène robuste et mettent de l'ordre dans ta salle de bains.

100% Baumwolle

100% coton



Die Aufbewahrungskörbe aus weicher und hautfreundlicher Baumwolle sind in diversen Farben und Formen erhältlich.

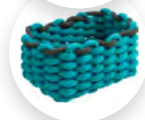

Les paniers de rangement en coton doux et agréable au toucher sont disponibles en diverses couleurs et formes.

Kosmetik- und Schmuckbehälter

Récipients pour cosmétiques et bijoux

Schmuckhalter Baum

Porte-bijoux arbre



Dank der stylischen Schmuckhalter in Baumform, kann Schmuck einfach und schnell verstaut werden.



Grand choix de produits de rangement au goût du jour, disponibles en différentes couleurs et en différents matériaux.

Serie Bambou

Série Bambou



Die Serie Bambou besteht 100% aus hochwertigem Bambus und sorgt für Ordnung in deinem Badezimmer.



La série Bambou est composée à 100% de bambou de qualité supérieure et permet d'organiser ta salle de bains.

Vielfältige Auswahl

Grand choix



Vielfältige Auswahl an weiteren Kosmetik- und Schmuckbehältern in diversen Farben und verschiedenen Materialien.



Choix varié d'autres récipients pour cosmétiques et bijoux dans diverses couleurs et différents matériaux.

Wäschebehälter

Bac à linge

Diverse Designs

Divers designs



Die Wäschebehälter sind in etlichen Farben, Formen, sowie Materialien erhältlich.

Les bacs à linge sont disponibles dans de nombreuses couleurs, formes et matériaux.

Wäschekorb Levi

Bac à linge Levi



Dank der schmalen, rechteckigen Form ist der Wäschekorb Levi kompakt und platzsparend. Kann mithilfe der flexiblen Rollen einfach verschoben werden.



Grâce à sa forme rectangulaire étroite, le panier à linge Levi est compact et peu encombrant. Il peut être facilement déplacé à l'aide des roulettes flexibles.



Aufbewahrung Rangement

| | EAN-Nr. <i>no EAN</i> | Artikel Nr. <i>no d'article</i> | Beschreibung <i>description</i> | VPE <i>ce</i> | VE <i>ue</i> | UVP pro Stk. <i>PVC</i> CHF excl. | UVP pro Stk. <i>PVC</i> CHF incl. |
|--|--------------------------|------------------------------------|------------------------------------|------------------|-----------------|---|---|
|--|--------------------------|------------------------------------|------------------------------------|------------------|-----------------|---|---|

Schmuckhalter Baum

Porte-bijoux arbre





| | | | | | | |
|--|-------------------|--|---|---|--------------|--------------|
|  7 611038 187613 | 45 1221 10 | schwarz <i>noir</i> Ø 15 x 25 cm | 1 |  | 32.62 | 35.13 |
|--|-------------------|--|---|---|--------------|--------------|

Schmuckhalter Baum Birdy

Porte-bijoux arbre Birdy





| | | | | | | |
|--|-------------------|---|---|---|--------------|--------------|
|  7 611038 178147 | 45 1221 12 | weiss <i>blanc</i> Ø 14 x 29.5 cm | 1 |  | 30.29 | 32.62 |
|--|-------------------|---|---|---|--------------|--------------|

Schmuckdose mit Spiegel

Boîte à bijoux avec miroir





| | | | | | | |
|--|-------------------|--|---|---|--------------|--------------|
|  7 611038 187606 | 45 1221 09 | weiss / Holz <i>blanc / bois</i> Ø 13.5 x 7.5 cm | 1 |  | 32.62 | 35.13 |
|--|-------------------|--|---|---|--------------|--------------|

Kosmetikspiegel mit Schublade

Miroir cosmétique avec tiroir



| | | | | | | |
|--|-------------------|---|---|---|--------------|--------------|
|  7 611038 175313 | 45 1221 11 | weiss / Holz <i>blanc / bois</i> 16.8 x 8 x 25 cm | 1 |  | 42.40 | 45.67 |
|--|-------------------|---|---|---|--------------|--------------|

Aufbewahrung Rangement

| | EAN-Nr. no EAN | Artikel Nr. no d'article | Beschreibung description | VPE ce | VE ue | UVP pro Stk. PVC CHF excl. | UVP pro Stk. PVC CHF incl. |
|--|-------------------|-----------------------------|-----------------------------|-----------|----------|----------------------------------|----------------------------------|
|--|-------------------|-----------------------------|-----------------------------|-----------|----------|----------------------------------|----------------------------------|

Ablageschale Bambou

Jatte Bambou



45 1221 13

Bambus
bambou
23.5 x 9 x 2.3 cm

1



27.49

29.61

100% Bambus
100% bambou



Organizer Bambou

Organiseur Bambou



45 1221 14

Bambus
bambou
16 x 11 x 11.5 cm

1



42.40

45.67

100% Bambus
100% bambou



NEW

Aufbewahrungsdose Bambou

Boîte de rangement Bambou



45 1221 34

Bambus
bambou
15 x 15 x 8 cm

1



15.75

16.96

100% Bambus
100% bambou



NEW

Schminkablage Bambou

Porte-maquillage Bambou



45 1221 33

Bambus
bambou
12 x 9 x 9 cm

1



13.89

14.96

100% Bambus
100% bambou



Aufbewahrung Rangement

NEW

| EAN-Nr. no EAN | Artikel Nr. no d'article | Beschreibung description | VPE ce | VE ue | UVP pro Stk. PVC CHF excl. | UVP pro Stk. PVC CHF incl. |
|-------------------|-----------------------------|-----------------------------|-----------|----------|----------------------------------|----------------------------------|
|-------------------|-----------------------------|-----------------------------|-----------|----------|----------------------------------|----------------------------------|

Papiertuchspender Bambou

Distrib. de serviettes Bambou



100% Bambus
100% bambou



45 1221 35

Bambus
bambou
25 x 13 x 9 cm

1



17.61

18.97



Halter für Smartphone

Support pour Smartphones



100% Polyresin
100% polyrésine



45 1221 25

anthrazit, rund
anthrazit, rond
14 x 14 x 3.3 cm

1



15.84

17.06



Halter für Tablet/Smartphone

Support pour Tablet/Smartphone



100% Polyresin
100% polyrésine



45 1221 26

anthrazit, rechteckig
anthrazit, rectangulaire
15 x 10 x 3 cm

1



15.84

17.06



Schminkablage Kasan

Porte-maquillage Kasan



45 1221 15

transparent
22 x 8 x 13 cm

1



10.62

11.44

1.60

Aufbewahrung Rangement

| | EAN-Nr. <i>no EAN</i> | Artikel Nr. <i>no d'article</i> | Beschreibung <i>description</i> | VPE <i>ce</i> | VE <i>ue</i> | UVP pro Stk. <i>PVC</i> CHF excl. | UVP pro Stk. <i>PVC</i> CHF incl. |
|--|--------------------------|------------------------------------|------------------------------------|------------------|-----------------|---|---|
|--|--------------------------|------------------------------------|------------------------------------|------------------|-----------------|---|---|

Organizer Omsk

Organiseur Omsk



45 1221 16

transparent
Ø 11.5 x 17.6 cm

1



10.62

11.44



Schminkablage Ufa

Porte-maquillage Ufa



45 1221 17

transparent
13.2 x 13.2 x 11.9 cm

1



10.62

11.44

NEW

Schminkablage Pensa

Porte-maquillage Pensa



45 1221 27

transparent, 360° rotierend
transparent, 360° tournant
11.5 x 11.5 x 11.8 cm

1



8.57

9.23



Aufbewahrung Rangement

| EAN-Nr. no EAN | Artikel Nr. no d'article | Beschreibung description | VPE ce | VE ue | UVP pro Stk. PVC CHF excl. | UVP pro Stk. PVC CHF incl. |
|-------------------|-----------------------------|-----------------------------|-----------|----------|----------------------------------|----------------------------------|
|-------------------|-----------------------------|-----------------------------|-----------|----------|----------------------------------|----------------------------------|

NEW

Schminkablage Tula

Porte-maquillage Tula



45 1221 28

transparent, 360° rotierend
transparent, 360° tournant
20 x 20 x 13 cm

1



10.62

11.44



NEW

Kosmetikset 3tlg. Mora

Set à cosmétique Mora



45 1221 30

transparent, Kork
transparent, liège
17.8 x 9.5 x 12 cm ; SET
3Stk/pcs

1



17.99

19.37



Organizer Seoul S



100% Polypropylen
100% polypropylène



45 1220 35

weiss
blanc
11.8 x 7.8 x 5.0 cm

5



1.63

1.76



45 1220 36

grau
gris
11.8 x 7.8 x 5.0 cm

5



1.63







1.76



Aufbewahrung Rangement





| | EAN-Nr. no EAN | Artikel Nr. no d'article | Beschreibung description | VPE ce | VE ue | UVP pro Stk. PVC CHF excl. | UVP pro Stk. PVC CHF incl. |
|--|-------------------|-----------------------------|-----------------------------|-----------|----------|----------------------------------|----------------------------------|
|--|-------------------|-----------------------------|-----------------------------|-----------|----------|----------------------------------|----------------------------------|

Organizer Seoul M

| | | | | | | | |
|--|--|-------------------|---------------------------------------|---|---|-------------|-------------|
|  100% Polypropylen 100% polypropylène |  5 707672 725815 | 45 1220 39 | weiss blanc 23.8 x 7.8 x 5.0 cm | 5 |  | 2.14 | 2.31 |
| |  5 707672 725839 | 45 1220 40 | grau gris 23.8 x 7.8 x 5.0 cm | 5 |  | 2.14 | 2.31 |
| |  5 707672 725822 | 45 1220 41 | blau bleu 23.8 x 7.8 x 5.0 cm | 5 |  | 2.14 | 2.31 |







Organizer Seoul L

| | | | | | | | |
|---|--|-------------------|--|---|---|-------------|-------------|
|  100% Polypropylen 100% polypropylène |  5 707672 725853 | 45 1220 43 | weiss blanc 15.8 x 11.8 x 7.3 cm | 5 |  | 2.38 | 2.56 |
| |  5 707672 725877 | 45 1220 44 | grau gris 15.8 x 11.8 x 7.3 cm | 5 |  | 2.38 | 2.56 |



Organizer Seoul XL

| | | | | | | | |
|--|--|-------------------|---|---|---|-------------|-------------|
|  100% Polypropylen 100% polypropylène |  5 707672 725891 | 45 1220 47 | weiss blanc 23.8 x 15.8 x 10.0 cm | 5 |  | 3.36 | 3.61 |
| |  5 707672 725914 | 45 1220 48 | grau gris 23.8 x 15.8 x 10.0 cm | 5 |  | 3.36 | 3.61 |





Aufbewahrung Rangement

| | EAN-Nr. no EAN | Artikel Nr. no d'article | Beschreibung description | VPE ce | VE ue | UVP pro Stk. PVC CHF excl. | UVP pro Stk. PVC CHF incl. |
|--|-------------------|-----------------------------|-----------------------------|-----------|----------|----------------------------------|----------------------------------|
|--|-------------------|-----------------------------|-----------------------------|-----------|----------|----------------------------------|----------------------------------|

Aufbewahrungskorb Samara

Panier Samara





| | | | | | | |
|---|-------------------|--|---|---|--------------|--------------|
|  | 45 1221 18 | blau <i>bleu</i> 19.2 x 9.3 x 8.0 cm | 1 |  | 15.94 | 17.16 |
|---|-------------------|--|---|---|--------------|--------------|

Aufbewahrungsschale Samara

Jatte Samara





| | | | | | | |
|---|-------------------|---------------------------|---|---|--------------|--------------|
|  | 45 1221 19 | pink 19.4 x 9 x 3.2 cm | 1 |  | 15.94 | 17.16 |
|---|-------------------|---------------------------|---|---|--------------|--------------|

Aufbewahrungskorb Jeans

Panier Jeans



| | | | | | | |
|---|-------------------|---|---|---|--------------|--------------|
|  | 45 1220 06 | schwarz <i>noir</i> 28 x 19 x 16 cm ; 6 L | 1 |  | 15.94 | 17.16 |
|---|-------------------|---|---|---|--------------|--------------|



100% Polyester
100% polyester

NEW

Aufbewahrungskorb Butterfly

Panier Butterfly





| | | | | | | |
|---|-------------------|--|---|---|--------------|--------------|
|  | 45 1220 60 | grau <i>gris</i> 28 x 19 x 16 cm ; 6 L | 1 |  | 15.94 | 17.16 |
|---|-------------------|--|---|---|--------------|--------------|

100% Polyester
100% polyester

Aufbewahrungskorb Papiro

Panier Papiro



| | | | | | | |
|---|-------------------|---|---|---|--------------|--------------|
|  | 45 1220 02 | braun <i>brun</i> 31 x 21 x 14 cm ; 6 L | 1 |  | 20.50 | 22.08 |
|---|-------------------|---|---|---|--------------|--------------|

100% Craft Paper



Aufbewahrung Rangement

| EAN-Nr. no EAN | Artikel Nr. no d'article | Beschreibung description | VPE ce | VE ue | UVP pro Stk. PVC CHF excl. | UVP pro Stk. PVC CHF incl. |
|-------------------|-----------------------------|-----------------------------|-----------|----------|----------------------------------|----------------------------------|
|-------------------|-----------------------------|-----------------------------|-----------|----------|----------------------------------|----------------------------------|

NEW

Aufbewahrungskorb Romance

Panier Romance



45 1221 38

braun
brun
35 x 20 x 20 cm ; 14 L

1



34.02

36.64

Wasserhyazinthe
Leinenstoff
Jacinthe d'eau
Tissu du lin



NEW

Aufbewahrungskorb Straw

Panier Straw



45 1221 37

braun
brun
29 x 19 x 13 cm ; 7 L

1



24.23

26.10

Seegras
Algues Marines

NEW

Aufbewahrungskorb Stone

Panier Stone



45 1221 36

grau
gris
31 x 21 x 14 cm ; 9 L

1



19.57

21.08

100% Filz-Polyester
100% feutre-polyester

Aufbewahrung Rangement







| | EAN-Nr. <i>no EAN</i> | Artikel Nr. <i>no d'article</i> | Beschreibung <i>description</i> | VPE <i>ce</i> | VE <i>ue</i> | UVP pro Stk. <i>PVC</i> CHF excl. | UVP pro Stk. <i>PVC</i> CHF incl. |
|--|--------------------------|------------------------------------|------------------------------------|------------------|-----------------|---|---|
|--|--------------------------|------------------------------------|------------------------------------|------------------|-----------------|---|---|

Aufbewahrungskorb Wove

Panier Wove



100% Polypropylen
100% polypropylène

| | | | | | | |
|---|-------------------|--|---|---|--------------|--------------|
|  | 45 1220 23 | grau <i>gris</i> 31 x 21 x 16 cm ; 9 L | 1 |  | 18.27 | 19.67 |
|  | 45 1220 24 | rosa <i>rose</i> 31 x 21 x 16 cm ; 9 L | 1 |  | 18.27 | 19.67 |
|  | 45 1220 25 | grün <i>vert</i> 31 x 21 x 16 cm ; 9 L | 1 |  | 18.27 | 19.67 |







NEW

Aufbewahrungskorb Big Stripe

Panier Big Stripe



100% Polypropylen
100% polypropylène

| | | | | | | |
|---|-------------------|---|---|---|--------------|--------------|
|  | 45 1220 65 | blau/weiss <i>bleu/blanc</i> 31 x 21 x 16 cm ; 9 L | 1 |  | 16.59 | 17.87 |
|  | 45 1220 66 | türkis/weiss <i>turquoise/blanc</i> 31 x 21 x 16 cm ; 9 L | 1 |  | 16.59 | 17.87 |



Aufbewahrung Rangement

| | EAN-Nr. no EAN | Artikel Nr. no d'article | Beschreibung description | VPE ce | VE ue | UVP pro Stk. PVC CHF excl. | UVP pro Stk. PVC CHF incl. |
|--|-------------------|-----------------------------|-----------------------------|-----------|----------|----------------------------------|----------------------------------|
|--|-------------------|-----------------------------|-----------------------------|-----------|----------|----------------------------------|----------------------------------|

NEW

Aufbewahrungsset Irina

Set de rangement Irina



| | | | | | | |
|---|-------------------|--|---|---|--------------|--------------|
|  | 45 1220 19 | weiss <i>blanc</i> 26 x 26 x 8 cm ; 4 Stk/pcs. | 1 |  | 20.97 | 22.58 |
|  | 45 1220 20 | grau <i>gris</i> 26 x 26 x 8 cm ; 4 Stk/pcs. | 1 |  | 20.97 | 22.58 |
|  | 45 1220 21 | aqua <i>aqua</i> 26 x 26 x 8 cm ; 4 Stk/pcs. | 1 |  | 20.97 | 22.58 |
|  | 45 1220 50 | taupe <i>taupe</i> 26 x 26 x 8 cm ; 4 Stk/pcs. | 1 |  | 20.97 | 22.58 |
|  | 45 1220 51 | schwarz <i>noir</i> 26 x 26 x 8 cm ; 4 Stk/pcs. | 1 |  | 20.97 | 22.58 |
|  | 45 1220 22 | dunkelblau <i>bleu</i> 26 x 26 x 8 cm ; 4 Stk/pcs. | 1 |  | 20.97 | 22.58 |





100% Polypropylen
100% polypropylène



Aufbewahrungskorb Felt

Panier Felt



| | | | | | | |
|---|-------------------|---|---|---|--------------|--------------|
|  | 45 1220 14 | grau/blau <i>gris/bleu</i> Ø 20 x 25 cm | 1 |  | 20.97 | 22.58 |
|---|-------------------|---|---|---|--------------|--------------|

100% Filz Polyester
100% feutre - polyester

Aufbewahrung Rangement

| EAN-Nr. no EAN | Artikel Nr. no d'article | Beschreibung description | VPE ce | VE ue | UVP pro Stk. PVC CHF excl. | UVP pro Stk. PVC CHF incl. |
|-------------------|-----------------------------|-----------------------------|-----------|----------|----------------------------------|----------------------------------|
|-------------------|-----------------------------|-----------------------------|-----------|----------|----------------------------------|----------------------------------|

NEW

Aufbewahrungskorb Cord

Panier Cord



45 1220 16

weiss
blanc
20 x 14 x 10 cm

1



17.15

18.47



45 1220 15

rosa
rose
20 x 14 x 10 cm

1



17.15

18.47



45 1220 17

mint
menthe
20 x 14 x 10 cm

1



17.15

18.47



45 1220 80

bordeauxrot
rouge bordeaux
20 x 14 x 10 cm

1



17.15

18.47



45 1220 81

petrol
20 x 14 x 10 cm

1



17.15

18.47



45 1220 18

dunkelblau
bleu
20 x 14 x 10 cm

1



17.15

18.47



100% Baumwolle
100% coton



















Aufbewahrung Rangement

| | EAN-Nr. <i>no EAN</i> | Artikel Nr. <i>no d'article</i> | Beschreibung <i>description</i> | VPE <i>ce</i> | VE <i>ue</i> | UVP pro Stk. <i>PVC</i> CHF excl. | UVP pro Stk. <i>PVC</i> CHF incl. |
|--|--------------------------|------------------------------------|------------------------------------|------------------|-----------------|---|---|
|--|--------------------------|------------------------------------|------------------------------------|------------------|-----------------|---|---|

Strickkorb Polly



Panier souple Polly

| | | | | | | | |
|---|---|-------------------|--|---|---|--------------|--------------|
|  <p>Polypropylen Polypropylène</p> |  | 45 1238 94 | weiss <i>blanc</i> Ø16 x 12 cm & 12 x 10 cm ; 2 Stk/pcs. | 1 |  | 18.08 | 19.47 |
| |  | 45 1231 94 | rose Ø16 x 12 cm & 12 x 10 cm ; 2 Stk/pcs. | 1 |  | 18.08 | 19.47 |
| |  | 45 1232 94 | taupe Ø16 x 12 cm & 12 x 10 cm ; 2 Stk/pcs. | 1 |  | 18.08 | 19.47 |
| |  | 45 1233 94 | grau <i>gris</i> Ø16 x 12 cm & 12 x 10 cm ; 2 Stk/pcs. | 1 |  | 18.08 | 19.47 |
| |  | 45 1234 94 | schwarz <i>noir</i> Ø16 x 12 cm & 12 x 10 cm ; 2 Stk/pcs. | 1 |  | 18.08 | 19.47 |
| |  | 45 1236 94 | blau <i>bleu</i> Ø16 x 12 cm & 12 x 10 cm ; 2 Stk/pcs. | 1 |  | 18.08 | 19.47 |
| |  | 45 1235 94 | grün <i>vert</i> Ø16 x 12 cm & 12 x 10 cm ; 2 Stk/pcs. | 1 |  | 18.08 | 19.47 |
| |  | 45 1237 94 | rot <i>rouge</i> Ø16 x 12 cm & 12 x 10 cm ; 2 Stk/pcs. | 1 |  | 18.08 | 19.47 |



Strickkorb Lina M

Panier Lina M

| | | | | | | | |
|---|---|-------------------|-------------------------------------|---|---|--------------|--------------|
|  |  | 45 1220 07 | grau <i>gris</i> Ø 16 x 15 cm | 1 |  | 18.08 | 19.47 |
|---|---|-------------------|-------------------------------------|---|---|--------------|--------------|

100% Polypropylen
100% polypropylène

Aufbewahrung Rangement

| | EAN-Nr. <i>no EAN</i> | Artikel Nr. <i>no d'article</i> | Beschreibung <i>description</i> | VPE <i>ce</i> | VE <i>ue</i> | UVP pro Stk. <i>PVC</i> CHF excl. | UVP pro Stk. <i>PVC</i> CHF incl. |
|--|--------------------------|------------------------------------|------------------------------------|------------------|-----------------|---|---|
|--|--------------------------|------------------------------------|------------------------------------|------------------|-----------------|---|---|

Strickkorb Lina L

Panier Lina L



45 1220 08

weiss
blanc
Ø 18 x 15 cm

1



20.50

22.08

100% Polypropylen
100% polypropylène

Aufbewahrungskorb Canvas

Panier Canvas



45 1220 01

beige, taupe
Ø 20 x 9 cm

1



10.62

11.44

35 % Baumwolle / 65% Polyester
35 % coton / 65% polyester

Aufbewahrungskorb Rope

Panier Rope



45 1220 04

écru
Ø 22 x 19 cm ; 4 L

1



18.08

19.47



45 1220 05

grau
gris
Ø 22 x 19 cm ; 4 L

1



18.08

19.47



45 1220 13

schwarz
noir
Ø 22 x 19 cm ; 4 L

1



18.08

19.47

100% Baumwolle
100% coton



NEW

Aufbewahrungskorb Lisha

Panier Lisha



45 1221 31

weiss, Seegras
blanc, zostère
20 x 20 x 12 cm ; 3.5 L

1



15.84

17.06



65% Baumwolle / 35% Polyester
100% Seegras
65% coton / 35% polyester
100% zostère



1.70

Aufbewahrung Rangement

| | EAN-Nr. <i>no EAN</i> | Artikel Nr. <i>no d'article</i> | Beschreibung <i>description</i> | VPE <i>ce</i> | VE <i>ue</i> | UVP pro Stk. <i>PVC</i> CHF excl. | UVP pro Stk. <i>PVC</i> CHF incl. |
|--|--------------------------|------------------------------------|------------------------------------|------------------|-----------------|---|---|
|--|--------------------------|------------------------------------|------------------------------------|------------------|-----------------|---|---|

Aufbewahrungskorb Maritim Panier Maritim





| | | | | | | |
|--|-------------------|--|---|---|--------------|--------------|
|  7 611038 181536 | 45 1220 03 | blau, weiss <i>bleu, blanc</i> Ø 30 x 35 cm ; 20 L | 1 |  | 20.97 | 22.58 |
|--|-------------------|--|---|---|--------------|--------------|

70% Polyester / 30% Baumwolle
70% polyester / 30% coton

Aufbewahrungskorb Pasta Panier Pasta





| | | | | | | |
|--|-------------------|---|---|---|--------------|--------------|
|  7 611038 181598 | 45 1220 09 | grau <i>gris</i> 32 x 31 x 29 cm ; 17 L | 1 |  | 29.36 | 31.62 |
|--|-------------------|---|---|---|--------------|--------------|

100% Filz-Polyester
100% feutre - polyester

Wäschesack Zik Zak Bac à linge Zik Zak



| | | | | | | |
|--|-------------------|---|---|---|--------------|--------------|
|  7 611038 181604 | 45 1220 10 | weiss/grau <i>blanc/gris</i> 68 x 33.5 x 70 cm ; 53 L | 1 |  | 42.87 | 46.17 |
|--|-------------------|---|---|---|--------------|--------------|

100% Polyester
100% polyester

Aufbewahrung Rangement

| | EAN-Nr. <i>no EAN</i> | Artikel Nr. <i>no d'article</i> | Beschreibung <i>description</i> | VPE <i>ce</i> | VE <i>ue</i> | UVP pro Stk. <i>PVC</i> CHF excl. | UVP pro Stk. <i>PVC</i> CHF incl. |
|--|--------------------------|------------------------------------|------------------------------------|------------------|-----------------|---|---|
|--|--------------------------|------------------------------------|------------------------------------|------------------|-----------------|---|---|

Wäschekorb Trezza

Bac à linge Trezza



45 1220 27

grau
gris
Ø 40 x 60 cm ; 62 L

1



53.12

57.21

100% Filz-Polyester
100% feutre - polyester

Wäschekorb Laundry Service

Bac à linge Laundry Service



45 1220 12

hellgrau
gris
Ø 38 x 48 cm ; 59 L

1



29.36

31.62

70% Baumwolle / 30% Polyester
70% coton / 30% polyester

NEW

Wäschekorb Words

Bac à linge Words



45 1224 31

rose
Ø 38 x 48 cm ; 59 L

1



29.36

31.62



45 1224 30

grau
gris
Ø 38 x 48 cm ; 59 L

1



29.36

31.62



70% Baumwolle / 30% Polyester
70% coton / 30% polyester

Aufbewahrung Rangement

| EAN-Nr. <i>no EAN</i> | Artikel Nr. <i>no d'article</i> | Beschreibung <i>description</i> | VPE <i>ce</i> | VE <i>ue</i> | UVP pro Stk. <i>PVC</i> CHF excl. | UVP pro Stk. <i>PVC</i> CHF incl. |
|--------------------------|------------------------------------|------------------------------------|------------------|-----------------|---|---|
|--------------------------|------------------------------------|------------------------------------|------------------|-----------------|---|---|

Wäschekorb Home

Bac à linge Home



45 1220 11

grau, faltbar
gris
40 x 30 x 60 cm ; 61 L

1



31.69

34.13

100% Polyester
100% polyester

NEW

Wäschekorb Levi

Bac à linge Levi



45 1224 20

dunkelblau
bleu foncé
42 x 26 x 60 cm ; 50 L

1



48.46

52.19



Platzsparend dank
schmaler, rechteckiger
Form
*Peu encombrant grâce à sa
forme rectangulaire étroite*



Bequemer Transport dank
4 flexiblen Rollen
*Transport confortable grâce
à 4 roulettes flexibles*

Wäschekorb Lori

Bac à linge Lori



45 1220 26

grau, faltbar
gris
46 x 37 x 61 cm ; 50 L

1



63.37

68.25

60% Polyester / 40% Baumwolle
/ Pinienholz
*60% polyester / 40% cotone / Bois
de pin*



Aufbewahrung Rangement

| | EAN-Nr. <i>no EAN</i> | Artikel Nr. <i>no d'article</i> | Beschreibung <i>description</i> | VPE <i>ce</i> | VE <i>ue</i> | UVP pro Stk. <i>PVC</i> CHF excl. | UVP pro Stk. <i>PVC</i> CHF incl. |
|--|--------------------------|------------------------------------|------------------------------------|------------------|-----------------|---|---|
|--|--------------------------|------------------------------------|------------------------------------|------------------|-----------------|---|---|

Wäschebehälter Iron

Bac à linge Iron





| | | | | | | |
|--|-------------------|---|---|---|--------------|--------------|
|  7 611038 183790 | 45 1220 28 | verchromt <i>chromé</i> 50 L ; Ø 34 x 60 cm | 1 |  | 63.37 | 68.25 |
|--|-------------------|---|---|---|--------------|--------------|

Wäschebehälter Baobab

Bac à linge Baobab



| | | | | | | |
|--|-------------------|---|---|---|--------------|--------------|
|  8 411801 224182 | 45 1220 29 | weiss <i>blanc</i> 40 L ; 41 x 33 x 50 cm | 1 |  | 35.88 | 38.64 |
|--|-------------------|---|---|---|--------------|--------------|





Stellacces- soires

*Accessoires
à poser*

Kapitel 2 - Inhaltsverzeichnis

Chapitre 2 - Sommaire

| | |
|---------------|------|
| Rainbow | 2.6 |
| Quadrotto | 2.10 |
| Cruz | 2.12 |
| Detre | 2.15 |
| Glady | 2.17 |
| Smilla | 2.20 |
| Priscilla | 2.22 |
| Trend frosted | 2.24 |
| Cement | 2.29 |
| Zylo | 2.31 |
| Mix & Match | 2.35 |
| Ardezio | 2.37 |
| Etosha | 2.39 |
| Sweet Home | 2.41 |
| Marina | 2.43 |
| Marmara | 2.45 |
| Trillium | 2.47 |
| Graphics | 2.49 |
| Circle | 2.51 |
| Ruen | 2.52 |
| Emilia | 2.53 |
| Yuma | 2.54 |
| Ruma | 2.57 |
| Grenada | 2.58 |
| Crushed | 2.60 |
| Ina | 2.61 |
| Pinta | 2.63 |
| Farin | 2.65 |
| Iris | 2.67 |
| Kira | 2.68 |
| Facette | 2.69 |
| Goli | 2.70 |
| Oak | 2.72 |





Stellaccessoires Accessoires à poser

Verschiedene Materialien Matériaux divers

Die Materialien reichen von Keramik über Holz zu Kunststoff bis hin zu Glas oder Metall.

Les matériaux vont de la céramique au bois, au plastique, au verre ou au métal.



Unterschiedliche Designs Différents designs

Ob modern, zeitlos klassisch, retro oder ein Mix aus allem. Unsere Designs treffen jeden Geschmack.

Que ce soit moderne, classique intemporel, rétro ou un mélange de tout cela. Nos designs répondent à tous les goûts.



Themenwelten Univers thématiques



Hello Yellow

Klassisches Gelb, Senfgelb, Bernsteinengelb oder Zartgelb mit viel neutralem Schwarz-Weiß oder Grau-Weiss im Badezimmer: Nichts strahlt mehr als ein Interieur mit sonnig-gelben Akzenten!

Jaune classique, jaune moutarde, jaune ambre ou jaune tendre avec beaucoup de noir et blanc neutre ou de gris et blanc dans la salle de bains : rien ne rayonne plus qu'un intérieur aux accents jaune soleil!

Capri Vibes

Capri, die „blaue Insel“ oder „Isola azzurra“ ist die Inspiration für unseren blauen Trend. Ein Badezimmer in den blauen Capri-farben ist Frische pur und gleichzeitig lädt die ruhige und klare Farbe zum Wohlfühlen ein.

Capri, «l'île bleue» ou «Isola azzurra» est l'inspiration de notre tendance bleue. Une salle de bains dans les couleurs bleues de Capri, c'est la fraîcheur à l'état pur et en même temps, cette couleur calme et claire invite au bien-être.



Eco-Line

Die Accessoires aus recyceltem Material sind nicht nur umweltfreundlich, sondern auch ästhetisch ansprechend. Entdecke unsere vielfältigen Sortimente in frischem blau, edlem beige oder elegantem mint-grün.

Les accessoires fabriqués à partir de matériaux recyclés sont non seulement respectueux de l'environnement, mais aussi très esthétiques. Découvre nos assortiments variés dans un bleu frais, un beige élégant ou un vert menthe élégant.

RAINBOW

















| EAN-Nr. <i>no EAN</i> | Artikel Nr. <i>no d'article</i> | Beschreibung <i>description</i> | VPE <i>ce</i> | VE <i>ue</i> | UVP pro Stk. <i>PVC</i> CHF excl. | UVP pro Stk. <i>PVC</i> CHF incl. |
|--------------------------|------------------------------------|------------------------------------|------------------|-----------------|---|---|
|--------------------------|------------------------------------|------------------------------------|------------------|-----------------|---|---|

WC-Bürstengarnitur Rainbow

Garniture de WC Rainbow





Kunststoff
Plastique

| | | | | | | |
|--|-------------------|--|---|---|--------------|--------------|
|  8 003341 168448 | 45 2190 02 | weiss <i>blanc</i> 9.8 x 9.8 x 37.5 cm | 4 |  | 57.78 | 62.23 |
|  8 003341 168455 | 45 2190 04 | grün <i>vert</i> 9.8 x 9.8 x 37.5 cm | 4 |  | 57.78 | 62.23 |
|  8 003341 168462 | 45 2190 05 | blau <i>bleu</i> 9.8 x 9.8 x 37.5 cm | 4 |  | 57.78 | 62.23 |
|  8 003341 168479 | 45 2190 06 | rot <i>rouge</i> 9.8 x 9.8 x 37.5 cm | 4 |  | 57.78 | 62.23 |
|  8 003341 168493 | 45 2190 14 | schwarz <i>noir</i> 9.8 x 9.8 x 37.5 cm | 4 |  | 57.78 | 62.23 |
|  8 003341 168509 | 45 2190 67 | orange 9.8 x 9.8 x 37.5 cm | 4 |  | 57.78 | 62.23 |
|  8 003341 173886 | 45 2190 73 | silber <i>argent</i> 9.8 x 9.8 x 37.5 cm | 4 |  | 57.78 | 62.23 |
|  8 003341 168516 | 45 2190 76 | pink <i>rose vif</i> 9.8 x 9.8 x 37.5 cm | 4 |  | 57.78 | 62.23 |



WC-Ersatzbürstenkopf

Brosse de rechange

| | | | | | | |
|--|-------------------|----------------------------------|---|---|--------------|--------------|
|  8 003341 171547 | 45 2170 98 | weiss <i>blanc</i> Ø 75 mm | 1 |  | 13.79 | 14.86 |
|--|-------------------|----------------------------------|---|---|--------------|--------------|

RAINBOW

















| EAN-Nr. <i>no EAN</i> | Artikel Nr. <i>no d'article</i> | Beschreibung <i>description</i> | VPE <i>ce</i> | VE <i>ue</i> | UVP pro Stk. <i>PVC</i> CHF excl. | UVP pro Stk. <i>PVC</i> CHF incl. |
|--------------------------|------------------------------------|------------------------------------|------------------|-----------------|---|---|
|--------------------------|------------------------------------|------------------------------------|------------------|-----------------|---|---|

Seifenspender Rainbow

Distributeur de savon Rainbow





Kunststoff
Plastique

| | | | | | | |
|---|-------------------|--|---|---|--------------|--------------|
|  | 45 2191 02 | weiss <i>blanc</i> 7 x 7 x 16.2 cm | 4 |  | 37.28 | 40.15 |
|  | 45 2191 04 | grün <i>vert</i> 7 x 7 x 16.2 cm | 4 |  | 37.28 | 40.15 |
|  | 45 2191 05 | blau <i>bleu</i> 7 x 7 x 16.2 cm | 4 |  | 37.28 | 40.15 |
|  | 45 2191 06 | rot <i>rouge</i> 7 x 7 x 16.2 cm | 4 |  | 37.28 | 40.15 |
|  | 45 2191 14 | schwarz <i>noir</i> 7 x 7 x 16.2 cm | 4 |  | 37.28 | 40.15 |
|  | 45 2191 67 | orange 7 x 7 x 16.2 cm | 4 |  | 37.28 | 40.15 |
|  | 45 2191 73 | silber <i>argent</i> 7 x 7 x 16.2 cm | 4 |  | 37.28 | 40.15 |
|  | 45 2191 79 | lila <i>lilas</i> 7 x 7 x 16.2 cm | 4 |  | 37.28 | 40.15 |



Ersatzpumpe

Pompe de rechange





| | | | | | | |
|---|-------------------|----------------------------|---|---|--------------|--------------|
|  | 45 2161 98 | verchromt <i>chromé</i> | 1 |  | 34.02 | 36.64 |
|---|-------------------|----------------------------|---|---|--------------|--------------|

Seifenspender gross Rainbow

Distributeur savon g Rainbow



Kunststoff
Plastique

| | | | | | | |
|---|-------------------|---|---|---|--------------|--------------|
|  | 45 2192 67 | orange 7 x 11.3 x 16.2 cm | 4 |  | 49.39 | 53.20 |
|  | 45 2192 06 | rot <i>rouge</i> 7 x 11.3 x 16.2 cm | 4 |  | 49.39 | 53.20 |

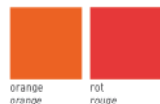

RAINBOW









| | EAN-Nr. no EAN | Artikel Nr. no d'article | Beschreibung description | VPE ce | VE ue | UVP pro Stk. PVC CHF excl. | UVP pro Stk. PVC CHF incl. |
|--|-------------------|-----------------------------|-----------------------------|-----------|----------|----------------------------------|----------------------------------|
|--|-------------------|-----------------------------|-----------------------------|-----------|----------|----------------------------------|----------------------------------|

Seifenschale Rainbow

Porte-savonnette Rainbow



Kunststoff
Plastique

| | | | | | | |
|---|-------------------|--|---|---|--------------|--------------|
|  | 45 2193 02 | weiss <i>blanc</i> 11 x 7 x 3 cm | 4 |  | 20.97 | 22.58 |
|  | 45 2193 06 | rot <i>rouge</i> 11 x 7 x 3 cm | 4 |  | 20.97 | 22.58 |
|  | 45 2193 14 | schwarz <i>noir</i> 11 x 7 x 3 cm | 4 |  | 20.97 | 22.58 |
|  | 45 2193 73 | silber <i>argent</i> 11 x 7 x 3 cm | 4 |  | 20.97 | 22.58 |





















Mundspülbecher Rainbow

Gobelet à dents Rainbow



Kunststoff
Plastique

| | | | | | | |
|---|-------------------|--|---|---|--------------|--------------|
|  | 45 2194 02 | weiss <i>blanc</i> 7.2 x 7.2 x 11 cm | 4 |  | 23.76 | 25.59 |
|  | 45 2194 04 | grün <i>vert</i> 7.2 x 7.2 x 11 cm | 4 |  | 23.76 | 25.59 |
|  | 45 2194 05 | blau <i>bleu</i> 7.2 x 7.2 x 11 cm | 4 |  | 23.76 | 25.59 |
|  | 45 2194 06 | rot <i>rouge</i> 7.2 x 7.2 x 11 cm | 4 |  | 23.76 | 25.59 |
|  | 45 2194 14 | schwarz <i>noir</i> 7.2 x 7.2 x 11 cm | 4 |  | 23.76 | 25.59 |
|  | 45 2194 67 | orange 7.2 x 7.2 x 11 cm | 4 |  | 23.76 | 25.59 |
|  | 45 2194 73 | silber <i>argent</i> 7.2 x 7.2 x 11 cm | 4 |  | 23.76 | 25.59 |
|  | 45 2194 76 | pink <i>rose vif</i> 7.2 x 7.2 x 11 cm | 4 |  | 23.76 | 25.59 |
|  | 45 2194 79 | lila <i>lilas</i> 7.2 x 7.2 x 11 cm | 4 |  | 23.76 | 25.59 |



RAINBOW

| | EAN-Nr. no EAN | Artikel Nr. no d'article | Beschreibung description | VPE ce | VE ue | UVP pro Stk. PVC CHF excl. | UVP pro Stk. PVC CHF incl. |
|--|-------------------|-----------------------------|-----------------------------|-----------|----------|----------------------------------|----------------------------------|
|--|-------------------|-----------------------------|-----------------------------|-----------|----------|----------------------------------|----------------------------------|

Papiertuchspender Rainbow

Distrib. de serviettes Rainbow



Kunststoffbox mit Boden
Box plastique avec couvercle

| | | | | | | |
|---|-------------------|-------------------------------------|---|---|--------------|--------------|
|  | 45 2196 04 | grün vert 25 x 13.5 x 7.5 cm | 4 |  | 43.80 | 47.17 |
|  | 45 2196 06 | rot rouge 25 x 13.5 x 7.5 cm | 4 |  | 43.80 | 47.17 |
|  | 45 2196 67 | orange 25 x 13.5 x 7.5 cm | 4 |  | 43.80 | 47.17 |
|  | 45 2196 79 | lila lilas 25 x 13.5 x 7.5 cm | 4 |  | 43.80 | 47.17 |



grün vert rot rouge orange orange lila lilas

Schminkablage Rainbow

Porte-maquillage Rainbow



Kunststoff
Plastique

| | | | | | | |
|---|-------------------|--------------------------------------|---|---|--------------|--------------|
|  | 45 2197 04 | grün vert 19 x 11 x 7.5 cm | 4 |  | 31.69 | 34.13 |
|  | 45 2197 06 | rot rouge 19 x 11 x 7.5 cm | 4 |  | 31.69 | 34.13 |
|  | 45 2197 73 | silber argent 19 x 11 x 7.5 cm | 4 |  | 31.69 | 34.13 |

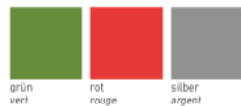

grün vert rot rouge silber argent





QUADROTTO

| EAN-Nr. <i>no EAN</i> | Artikel Nr. <i>no d'article</i> | Beschreibung <i>description</i> | VPE <i>ce</i> | VE <i>ue</i> | UVP pro Stk. <i>PVC</i> CHF excl. | UVP pro Stk. <i>PVC</i> CHF incl. |
|--------------------------|------------------------------------|------------------------------------|------------------|-----------------|---|---|
|--------------------------|------------------------------------|------------------------------------|------------------|-----------------|---|---|

WC-Bürstengarnitur Quadrotto

Garniture de WC Quadrotto





| | | | | | | |
|--|-------------------|---|---|---|--------------|--------------|
|  8 003341 090473 | 45 2223 50 | weiss <i>blanc</i> 9.5 x 9.5 x 38 cm | 4 |  | 49.39 | 53.20 |
|  8 003341 090480 | 45 2223 40 | schwarz <i>noir</i> 9.5 x 9.5 x 38 cm | 4 |  | 49.39 | 53.20 |



Kunststoff
Plastique

WC-Ersatzbürstenkopf





Brosse de rechange

| | | | | | | |
|---|-------------------|-----------------------------------|---|--|-------------|-------------|
|  8 003341 007617 | 45 2223 48 | schwarz <i>noir</i> Ø 75 mm | 1 |  | 8.85 | 9.54 |
|---|-------------------|-----------------------------------|---|--|-------------|-------------|

Seifenspender Quadrotto

Distributeur savon Quadrotto





| | | | | | | |
|--|-------------------|---|---|---|--------------|--------------|
|  8 003341 197653 | 45 2223 51 | weiss <i>blanc</i> 8.2 x 8.2 x 16 cm | 4 |  | 35.41 | 38.14 |
|  8 003341 183465 | 45 2223 41 | schwarz <i>noir</i> 8.2 x 8.2 x 16 cm | 4 |  | 35.41 | 38.14 |



Kunststoff
Plastique



Ersatzpumpe

Pompe de rechange

| | | | | | | |
|--|-------------------|----------------------------|---|---|--------------|--------------|
|  8 003341 022276 | 45 2223 46 | verchromt <i>chromé</i> | 1 |  | 20.50 | 22.08 |
|--|-------------------|----------------------------|---|---|--------------|--------------|





QUADROTTO

| EAN-Nr. <i>no EAN</i> | Artikel Nr. <i>no d'article</i> | Beschreibung <i>description</i> | VPE <i>ce</i> | VE <i>ue</i> | UVP pro Stk. <i>PVC</i> CHF excl. | UVP pro Stk. <i>PVC</i> CHF incl. |
|--------------------------|------------------------------------|------------------------------------|------------------|-----------------|---|---|
|--------------------------|------------------------------------|------------------------------------|------------------|-----------------|---|---|

| Seifenschale Quadrotto | | Porte-savonnette Quadrotto | | | | | |
|---|--|----------------------------|--|---|---|--------------|--------------|
|  |  8 003341 183458 | 45 2223 42 | schwarz <i>noir</i> 11.7 x 11.7 x 2.7 cm | 4 |  | 19.57 | 21.08 |

Kunststoff
Plastique



| Zahnbürstenhalter Quadrotto | | Porte-brosse à dents Quadrotto | | | | | |
|---|--|--------------------------------|--|---|---|--------------|--------------|
|  |  8 003341 197646 | 45 2223 53 | weiss <i>blanc</i> 10.2 x 6.2 x 11.5 cm | 4 |  | 21.90 | 23.59 |
| |  8 003341 183441 | 45 2223 43 | schwarz <i>noir</i> 10.2 x 6.2 x 11.5 cm | 4 |  | 21.90 | 23.59 |

Kunststoff
Plastique



CRUZ

| EAN-Nr. no EAN | Artikel Nr. no d'article | Beschreibung description | VPE ce | VE ue | UVP pro Stk. PVC CHF excl. | UVP pro Stk. PVC CHF incl. |
|-------------------|-----------------------------|-----------------------------|-----------|----------|----------------------------------|----------------------------------|
|-------------------|-----------------------------|-----------------------------|-----------|----------|----------------------------------|----------------------------------|

WC-Bürstengarnitur Cruz

Garniture de WC Cruz





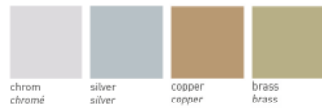

Kunststoff
Plastique

| | | | | | | |
|---|-------------------|---|---|---|--------------|--------------|
|  | 48 2080 09 | verchromt <i>chromé</i> Ø 9.5 x 38 cm | 1 |  | 54.05 | 58.22 |
|  | 48 2080 73 | silver Ø 9.5 x 38 cm | 1 |  | 53.12 | 57.21 |
|  | 48 2080 83 | copper Ø 9.5 x 38 cm | 1 |  | 53.12 | 57.21 |
|  | 48 2080 85 | brass Ø 9.5 x 38 cm | 1 |  | 53.12 | 57.21 |



WC-Ersatzbürstenkopf

Brosse de rechange







| | | | | | | |
|---|-------------------|-----------------------------------|-----|---|-------------|-------------|
|  | 45 9998 98 | weiss <i>blanc</i> Ø 80 mm | 100 |  | 8.39 | 9.03 |
|  | 45 9999 98 | schwarz <i>noir</i> Ø 80 mm | 100 |  | 8.39 | 9.03 |

Seifenspender Cruz

Distributeur de savon Cruz



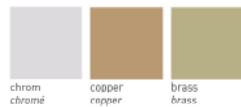

Kunststoff
Plastique

| | | | | | | |
|---|-------------------|---|---|---|--------------|--------------|
|  | 48 2081 09 | verchromt <i>chromé</i> Ø 7.3 x 17 cm | 1 |  | 20.04 | 21.58 |
|  | 48 2081 83 | copper Ø 7.3 x 17 cm | 1 |  | 20.04 | 21.58 |
|  | 48 2081 85 | brass Ø 7 x 17 cm | 1 |  | 20.04 | 21.58 |



Ersatzpumpe

Pompe de rechange

| | | | | | | |
|---|-------------------|----------------------------|---|---|--------------|--------------|
|  | 48 2041 96 | verchromt <i>chromé</i> | 1 |  | 13.61 | 14.65 |
|---|-------------------|----------------------------|---|---|--------------|--------------|

CRUZ

| | EAN-Nr. no EAN | Artikel Nr. no d'article | Beschreibung description | VPE ce | VE ue | UVP pro Stk. PVC CHF excl. | UVP pro Stk. PVC CHF incl. |
|--|-------------------|-----------------------------|-----------------------------|-----------|----------|----------------------------------|----------------------------------|
|--|-------------------|-----------------------------|-----------------------------|-----------|----------|----------------------------------|----------------------------------|

| | |
|--------------------------|------------------------------|
| Seifenschale Cruz | Porte-savonnette Cruz |
|--------------------------|------------------------------|



Kunststoff
Plastique

| | | | | | | |
|---|-------------------|---|---|---|--------------|--------------|
|  | 48 2083 09 | verchromt <i>chromé</i> Ø 11 x 3 cm | 1 |  | 13.33 | 14.35 |
|  | 48 2083 73 | silver Ø 11 x 3 cm | 1 |  | 13.33 | 14.35 |
|  | 48 2083 83 | copper Ø 11 x 3 cm | 1 |  | 13.33 | 14.35 |
|  | 48 2083 85 | brass Ø 11 x 3 cm | 1 |  | 13.33 | 14.35 |

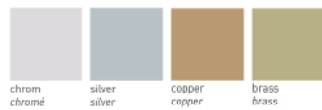

| | |
|----------------------------|-----------------------------|
| Mundspülbecher Cruz | Gobelet à dents Cruz |
|----------------------------|-----------------------------|



Kunststoff
Plastique

| | | | | | | |
|---|-------------------|---|---|---|--------------|--------------|
|  | 48 2082 09 | verchromt <i>chromé</i> Ø 7 x 11.9 cm | 1 |  | 13.33 | 14.35 |
|  | 48 2082 73 | silver Ø 7 x 11.9 cm | 1 |  | 13.33 | 14.35 |
|  | 48 2082 83 | copper Ø 7 x 11.9 cm | 1 |  | 13.33 | 14.35 |
|  | 48 2082 85 | brass Ø 7 x 11.9 cm | 1 |  | 13.33 | 14.35 |

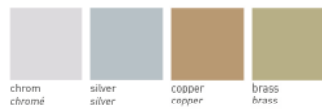

CRUZ

| EAN-Nr. <i>no EAN</i> | Artikel Nr. <i>no d'article</i> | Beschreibung <i>description</i> | VPE <i>ce</i> | VE <i>ue</i> | UVP pro Stk. <i>PVC</i> CHF excl. | UVP pro Stk. <i>PVC</i> CHF incl. |
|--------------------------|------------------------------------|------------------------------------|------------------|-----------------|---|---|
|--------------------------|------------------------------------|------------------------------------|------------------|-----------------|---|---|

| WC-Sitz Madrid Slow Down | | Siège de WC Madrid Slow Down | | | | | |
|--------------------------|--|------------------------------|--|--|--|--|--|
|--------------------------|--|------------------------------|--|--|--|--|--|



31 1704 73

silver - MDF - FSC® 100%
42-46.5 x 37.1 cm ; 16

4



94.13

101.38



31 1704 83

copper - MDF - FSC® 100%
42-46.5 x 37.1 cm ; 16

4



94.13

101.38

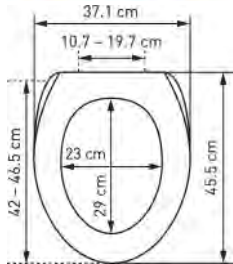

Das Zeichen für verantwortungsvolle Waldwirtschaft
Le triangle de la gestion forestière responsable

mit Metall-Scharnieren
avec charnières en métal

DETRE





| EAN-Nr. no EAN | Artikel Nr. no d'article | Beschreibung description | VPE ce | VE ue | UVP pro Stk. PVC CHF excl. | UVP pro Stk. PVC CHF incl. |
|-------------------|-----------------------------|-----------------------------|-----------|----------|----------------------------------|----------------------------------|
|-------------------|-----------------------------|-----------------------------|-----------|----------|----------------------------------|----------------------------------|

WC-Bürstengarnitur Detre

Garniture de WC Detre



Kunststoff
Plastique

| | | | | | | |
|--|-------------------|----------------------------------|---|---|--------------|--------------|
|  7 611038 137755 | 48 2040 41 | weiss blanc Ø 9.5 x 38 cm | 1 |  | 34.02 | 36.64 |
|  7 611038 137762 | 48 2040 80 | schwarz noir Ø 9.5 x 38 cm | 1 |  | 34.02 | 36.64 |



WC-Ersatzbürstenkopf

Brosse de rechange





| | | | | | | |
|--|-------------------|----------------------------|-----|---|-------------|-------------|
|  7 611038 116583 | 45 9998 98 | weiss blanc Ø 80 mm | 100 |  | 8.39 | 9.03 |
|  7 611038 116590 | 45 9999 98 | schwarz noir Ø 80 mm | 100 |  | 8.39 | 9.03 |

Seifenspender Detre

Distributeur de savon Detre





Kunststoff
Plastique

| | | | | | | |
|--|-------------------|----------------------------------|---|---|--------------|--------------|
|  7 611038 137670 | 48 2041 41 | weiss blanc Ø 7 x 18.2 cm | 1 |  | 16.40 | 17.67 |
|  7 611038 137687 | 48 2041 80 | schwarz noir Ø 7 x 18.2 cm | 1 |  | 16.40 | 17.67 |



Ersatzpumpe

Pompe de rechange





| | | | | | | |
|--|-------------------|---------------------|---|---|--------------|--------------|
|  7 611038 139650 | 48 2041 96 | verchromt chromé | 1 |  | 13.61 | 14.65 |
|--|-------------------|---------------------|---|---|--------------|--------------|

Seifenschale Detre

Porte-savonnette Detre



Kunststoff
Plastique

| | | | | | | |
|--|-------------------|--------------------------------------|---|---|-------------|-------------|
|  7 611038 137717 | 48 2043 41 | weiss blanc 13 x 9.5 x 1.2 cm | 1 |  | 8.15 | 8.78 |
|  7 611038 137724 | 48 2043 80 | schwarz noir 13 x 9.5 x 1.2 cm | 1 |  | 8.15 | 8.78 |







DETRE

| EAN-Nr. <i>no EAN</i> | Artikel Nr. <i>no d'article</i> | Beschreibung <i>description</i> | VPE <i>ce</i> | VE <i>ue</i> | UVP pro Stk. <i>PVC</i> CHF excl. | UVP pro Stk. <i>PVC</i> CHF incl. |
|--------------------------|------------------------------------|------------------------------------|------------------|-----------------|---|---|
|--------------------------|------------------------------------|------------------------------------|------------------|-----------------|---|---|

| | |
|-----------------------------|------------------------------|
| Mundspülbecher Detre | Gobelet à dents Detre |
|-----------------------------|------------------------------|



Kunststoff
Plastique

| | | | | | | |
|--|-------------------|---|---|---|--------------|--------------|
|  7 611038 137694 | 48 2042 41 | weiss <i>blanc</i> Ø 7 x 11.5 cm | 1 |  | 10.81 | 11.64 |
|  7 611038 136901 | 48 2042 80 | schwarz <i>noir</i> Ø 7 x 11.5 cm | 1 |  | 10.81 | 11.64 |



GLADY













| EAN-Nr. no EAN | Artikel Nr. no d'article | Beschreibung description | VPE ce | VE ue | UVP pro Stk. PVC CHF excl. | UVP pro Stk. PVC CHF incl. |
|-------------------|-----------------------------|-----------------------------|-----------|----------|----------------------------------|----------------------------------|
|-------------------|-----------------------------|-----------------------------|-----------|----------|----------------------------------|----------------------------------|

WC-Bürstengarnitur Glady

Garniture de WC Glady



Kunststoff
Plastique

| | | | | | | |
|--|-------------------|---------------------------------------|---|---|--------------|--------------|
|  8 003341 186855 | 45 2260 00 | transparent Ø 13.2 x 37 cm | 6 |  | 25.63 | 27.60 |
|  8 003341 102602 | 45 2260 04 | grün vert Ø 13.2 x 37 cm | 6 |  | 25.63 | 27.60 |
|  8 003341 186879 | 45 2260 67 | orange Ø 13.2 x 37 cm | 6 |  | 25.63 | 27.60 |
|  8 003341 186886 | 45 2260 76 | pink rose vif Ø 13.2 x 37 cm | 6 |  | 25.63 | 27.60 |
|  8 003341 186893 | 45 2260 79 | lila lilas Ø 13.2 x 37 cm | 6 |  | 25.63 | 27.60 |
|  8 003341 186909 | 45 2260 92 | türkis turquoise Ø 13.2 x 37 cm | 6 |  | 25.63 | 27.60 |















Seifenspender Glady

Distributeur de savon Glady





Kunststoff
Plastique

| | | | | | | |
|--|-------------------|--------------------------------------|---|---|--------------|--------------|
|  8 003341 149836 | 45 2261 00 | transparent Ø 8.5 x 17 cm | 6 |  | 13.98 | 15.06 |
|  8 003341 102619 | 45 2261 04 | grün vert Ø 8.5 x 17 cm | 6 |  | 13.98 | 15.06 |
|  8 003341 186824 | 45 2261 67 | orange Ø 8.5 x 17 cm | 6 |  | 13.98 | 15.06 |
|  8 003341 186831 | 45 2261 76 | pink rose vif Ø 8.5 x 17 cm | 6 |  | 13.98 | 15.06 |
|  8 003341 186848 | 45 2261 79 | lila lilas Ø 8.5 x 17 cm | 6 |  | 13.98 | 15.06 |
|  8 003341 149850 | 45 2261 92 | türkis turquoise Ø 8.5 x 17 cm | 6 |  | 13.98 | 15.06 |







Ersatzpumpe

Pompe de rechange













| | | | | | | |
|--|-------------------|---------------------|---|---|-------------|--------------|
|  8 003341 184059 | 45 2261 98 | verchromt chromé | 1 |  | 9.51 | 10.24 |
|--|-------------------|---------------------|---|---|-------------|--------------|

GLADY

| | EAN-Nr. no EAN | Artikel Nr. no d'article | Beschreibung description | VPE ce | VE ue | UVP pro Stk. PVC CHF excl. | UVP pro Stk. PVC CHF incl. |
|---|--|-------------------------------|--------------------------------------|------------------|---|----------------------------------|----------------------------------|
| Seifenschale GladY | | Porte-savonnette GladY | | | | | |
|  <p>Kunststoff Plastique</p> |  8 003341 149805 | 45 2262 00 | transparent 13 x 8 x 4 cm | 6 |  | 9.60 | 10.34 |
| |  8 003341 102596 | 45 2262 04 | grün vert 13 x 8 x 4 cm | 6 |  | 9.60 | 10.34 |
| |  8 003341 186794 | 45 2262 67 | orange 13 x 8 x 4 cm | 6 |  | 9.60 | 10.34 |
| |  8 003341 186800 | 45 2262 76 | pink rose vif 13 x 8 x 4 cm | 6 |  | 9.60 | 10.34 |
| |  8 003341 186817 | 45 2262 79 | lila lilas 13 x 8 x 4 cm | 6 |  | 9.60 | 10.34 |
| |  8 003341 149829 | 45 2262 92 | türkis turquoise 13 x 8 x 4 cm | 6 |  | 9.60 | 10.34 |
| |  | transparent transparent | grün vert | orange orange | pink rose vif | lila lilas | türkis turquoise |

| | EAN-Nr. no EAN | Artikel Nr. no d'article | Beschreibung description | VPE ce | VE ue | UVP pro Stk. PVC CHF excl. | UVP pro Stk. PVC CHF incl. |
|---|--|------------------------------|--------------------------------------|------------------|---|----------------------------------|----------------------------------|
| Mundspülbecher GladY | | Gobelet à dents GladY | | | | | |
|  <p>Kunststoff Plastique</p> |  8 003341 149775 | 45 2263 00 | transparent Ø 8.5 x 11 cm | 6 |  | 9.60 | 10.34 |
| |  8 003341 149782 | 45 2263 04 | grün vert Ø 8.5 x 11 cm | 6 |  | 9.60 | 10.34 |
| |  8 003341 186763 | 45 2263 67 | orange Ø 8.5 x 11 cm | 6 |  | 9.60 | 10.34 |
| |  8 003341 186770 | 45 2263 76 | pink rose vif Ø 8.5 x 11 cm | 6 |  | 9.60 | 10.34 |
| |  8 003341 186787 | 45 2263 79 | lila lilas Ø 8.5 x 11 cm | 6 |  | 9.60 | 10.34 |
| |  8 003341 149799 | 45 2263 92 | türkis turquoise Ø 8.5 x 11 cm | 6 |  | 9.60 | 10.34 |
| |  | transparent transparent | grün vert | orange orange | pink rose vif | lila lilas | türkis turquoise |

GLADY

| | EAN-Nr. <i>no EAN</i> | Artikel Nr. <i>no d'article</i> | Beschreibung <i>description</i> | VPE <i>ce</i> | VE <i>ue</i> | UVP pro Stk. <i>PVC</i> CHF excl. | UVP pro Stk. <i>PVC</i> CHF incl. |
|--|--|------------------------------------|--|------------------|---|---|---|
| Schminkablage GladY | | Porte-maquillage GladY | | | | | |
|  <p>Kunststoff <i>Plastique</i></p> |  8 003341 199602 | 45 2264 00 | transparent 18.5 x 10.5 x 7.5 cm | 6 |  | 19.57 | 21.08 |
| |  8 003341 199619 | 45 2264 04 | grün <i>vert</i> 18.5 x 10.5 x 7.5 cm | 6 |  | 19.57 | 21.08 |
| |  8 003341 199626 | 45 2264 67 | orange 18.5 x 10.5 x 7.5 cm | 6 |  | 19.57 | 21.08 |
| |  8 003341 199633 | 45 2264 76 | pink <i>rose vif</i> 18.5 x 10.5 x 7.5 cm | 6 |  | 19.57 | 21.08 |
| |  8 003341 199640 | 45 2264 79 | lila <i>lilas</i> 18.5 x 10.5 x 7.5 cm | 6 |  | 19.57 | 21.08 |
| |  8 003341 199657 | 45 2264 92 | türkis <i>turquoise</i> 18.5 x 10.5 x 7.5 cm | 6 |  | 19.57 | 21.08 |



SMILLA





| EAN-Nr. no EAN | Artikel Nr. no d'article | Beschreibung description | VPE ce | VE ue | UVP pro Stk. PVC CHF excl. | UVP pro Stk. PVC CHF incl. |
|-------------------|-----------------------------|-----------------------------|-----------|----------|----------------------------------|----------------------------------|
|-------------------|-----------------------------|-----------------------------|-----------|----------|----------------------------------|----------------------------------|

NEW

WC-Bürstengarnitur Smilla

Garniture de WC Smilla







| | | | | | | |
|--|-------------------|----------------------------|---|---|--------------|--------------|
|  7 611038 692872 | 48 2350 00 | aqua 9.5 x 9.5 x 36CM | 1 |  | 23.25 | 25.04 |
|  7 611038 692889 | 48 2351 00 | beige 9.5 x 9.5 x 36 cm | 1 |  | 23.25 | 25.04 |



51% recyceltes Kunstharz
49% Kunstharz
51% résine synthétique recyclée
49% résine synthétique

WC-Ersatzbürstenkopf

Brosse de rechange





| | | | | | | |
|---|-------------------|----------------------------|-----|--|-------------|-------------|
|  7 611038 116583 | 45 9998 98 | weiss blanc Ø 80 mm | 100 |  | 8.39 | 9.03 |
|  7 611038 116590 | 45 9999 98 | schwarz noir Ø 80 mm | 100 |  | 8.39 | 9.03 |

NEW

Seifenspender Smilla

Distributeur Savon Smilla



| | | | | | | |
|--|-------------------|------------------------------|---|---|--------------|-------------|
|  7 611038 692773 | 48 2350 01 | aqua 7.3 x 7.3 x 16.6 cm | 1 |  | 12.07 | 13.— |
|  7 611038 692810 | 48 2351 01 | beige 7.3 x 7.3 x 16.6 cm | 1 |  | 12.07 | 13.— |



51% recyceltes Kunstharz
49% Kunstharz
51% résine synthétique recyclée
49% résine synthétique

SMILLA

| EAN-Nr. no EAN | Artikel Nr. no d'article | Beschreibung description | VPE ce | VE ue | UVP pro Stk. PVC CHF excl. | UVP pro Stk. PVC CHF incl. |
|-------------------|-----------------------------|-----------------------------|-----------|----------|----------------------------------|----------------------------------|
|-------------------|-----------------------------|-----------------------------|-----------|----------|----------------------------------|----------------------------------|

NEW

Mundspülbecher Smilla

Gobelet à dents Smilla



48 2350 02

aqua
7.3 x 7.3 x 10 cm

1



9.27

9.99



48 2351 02

beige
7.3 x 7.3 x 10 cm

1



9.27

9.99

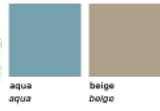

51% recyceltes Kunstharz
49% Kunstharz
51% résine synthétique recyclée
49% résine synthétique

NEW

Seifenschale Smilla

Porte-savonette Smilla



48 2350 03

aqua
12.7 x 9 x 2.4 cm

1



9.27

9.99



48 2351 03

beige
12.7 x 8.6 x 2.4 cm

1



9.27

9.99

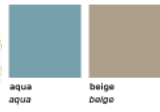

51% recyceltes Kunstharz
49% Kunstharz
51% résine synthétique recyclée
49% résine synthétique

NEW

Kosmetikdose Smilla

Boîte cosmétique Smilla



48 2350 05

aqua
9.5 x 9.5 x 9.5 cm

1



12.07

13.—



48 2351 05

beige
9.5 x 9.5 x 9.5 cm

1



12.07

13.—

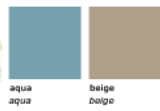

51% recyceltes Kunstharz
49% Kunstharz
51% résine synthétique recyclée
49% résine synthétique

PRISCILLA













| EAN-Nr. no EAN | Artikel Nr. no d'article | Beschreibung description | VPE ce | VE ue | UVP pro Stk. PVC CHF excl. | UVP pro Stk. PVC CHF incl. |
|-------------------|-----------------------------|-----------------------------|-----------|----------|----------------------------------|----------------------------------|
|-------------------|-----------------------------|-----------------------------|-----------|----------|----------------------------------|----------------------------------|

WC-Bürstengarnitur Priscilla

Garniture de WC Priscilla





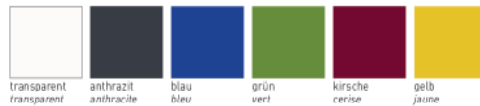

Kunststoff
Plastique

| | | | | | | |
|--|-------------------|--|---|---|--------------|--------------|
|  7 611038 249410 | 48 2331 00 | transparent Ø 10.7 x 37.5 cm | 4 |  | 15.56 | 16.76 |
|  7 611038 249427 | 48 2343 00 | anthrazit transparent Ø 10.7 x 37.5 cm | 4 |  | 15.56 | 16.76 |
|  7 611038 249434 | 48 2344 00 | blau transparent <i>bleu transparent</i> Ø 10.7 x 37.5 cm | 4 |  | 15.56 | 16.76 |
|  7 611038 249441 | 48 2345 00 | grün transparent <i>vert transparent</i> Ø 10.7 x 37.5 cm | 4 |  | 15.56 | 16.76 |
|  7 611038 249458 | 48 2346 00 | kirsche transparent <i>cerise transparent</i> Ø 10.7 x 37.5 cm | 4 |  | 15.56 | 16.76 |
|  7 611038 249465 | 48 2347 00 | gelb transparent <i>jaune transparent</i> Ø 10.7 x 37.5 cm | 4 |  | 15.56 | 16.76 |



WC-Ersatzbürstenkopf

Brosse de rechange

| | | | | | | |
|--|-------------------|-----------------------------------|---|---|-------------|-------------|
|  7 611038 181468 | 45 9993 98 | weiss <i>blanc</i> Ø 75 mm | 1 |  | 8.95 | 9.64 |
|  7 611038 181451 | 45 9994 98 | schwarz <i>noir</i> Ø 75 mm | 1 |  | 8.95 | 9.64 |

PRISCILLA













| EAN-Nr. no EAN | Artikel Nr. no d'article | Beschreibung description | VPE ce | VE ue | UVP pro Stk. PVC CHF excl. | UVP pro Stk. PVC CHF incl. |
|-------------------|-----------------------------|-----------------------------|-----------|----------|----------------------------------|----------------------------------|
|-------------------|-----------------------------|-----------------------------|-----------|----------|----------------------------------|----------------------------------|

Seifenspender Priscilla

Distributeur Savon Priscilla



Kunststoff
Plastique

| | | | | | | |
|--|-------------------|---|---|---|-------------|--------------|
|  7 611038 243388 | 48 2331 01 | transparent Ø 6.9 x 16.5 cm | 4 |  | 9.51 | 10.24 |
|  7 611038 249472 | 48 2343 01 | anthrazit transparent Ø 6.9 x 16.5 cm | 4 |  | 9.51 | 10.24 |
|  7 611038 249489 | 48 2344 01 | blau transparent <i>bleu transparent</i> Ø 6.9 x 16.5 cm | 4 |  | 9.51 | 10.24 |
|  7 611038 249496 | 48 2345 01 | grün transparent <i>vert transparent</i> Ø 6.9 x 16.5 cm | 4 |  | 9.51 | 10.24 |
|  7 611038 249502 | 48 2346 01 | kirsche transparent <i>cerise transparent</i> Ø 6.9 x 16.5 cm | 4 |  | 9.51 | 10.24 |
|  7 611038 249519 | 48 2347 01 | gelb transparent <i>jaune transparent</i> Ø 6.9 x 16.5 cm | 4 |  | 9.51 | 10.24 |

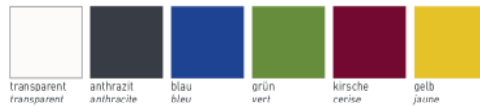













Mundspülbecher Priscilla

Gobelet à dents Priscilla



Kunststoff
Plastique

| | | | | | | |
|--|-------------------|---|---|---|-------------|-------------|
|  7 611038 243371 | 48 2331 02 | transparent Ø 6.9 x 11 cm | 4 |  | 5.92 | 6.37 |
|  7 611038 249526 | 48 2343 02 | anthrazit transparent Ø 6.9 x 11 cm | 4 |  | 5.92 | 6.37 |
|  7 611038 249533 | 48 2344 02 | blau transparent <i>bleu transparent</i> Ø 6.9 x 11 cm | 4 |  | 5.92 | 6.37 |
|  7 611038 249540 | 48 2345 02 | grün transparent <i>vert transparent</i> Ø 6.9 x 11 cm | 4 |  | 5.92 | 6.37 |
|  7 611038 249557 | 48 2346 02 | kirsche transparent <i>cerise transparent</i> Ø 6.9 x 11 cm | 4 |  | 5.92 | 6.37 |
|  7 611038 249564 | 48 2347 02 | gelb transparent <i>jaune transparent</i> Ø 6.9 x 11 cm | 4 |  | 5.92 | 6.37 |

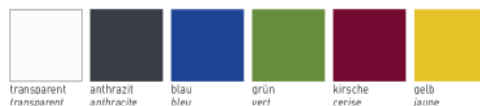













TREND FROSTED

| EAN-Nr. no EAN | Artikel Nr. no d'article | Beschreibung description | VPE ce | VE ue | UVP pro Stk. PVC CHF excl. | UVP pro Stk. PVC CHF incl. |
|-------------------|-----------------------------|-----------------------------|-----------|----------|----------------------------------|----------------------------------|
|-------------------|-----------------------------|-----------------------------|-----------|----------|----------------------------------|----------------------------------|

WC-Bürstengarnit.Trend Frosted

Garniture de WC Trend Frosted

| | | | | | | | |
|---|--|-------------------|--|---|---|--------------|--------------|
|  <p>Polypropylen Polypropylène</p> |  7 611038 021139 | 45 1967 09 | weiss transparent <i>blanc transparent</i> Ø 9.5 x 38.5 cm | 1 |  | 20.04 | 21.58 |
| |  7 611038 085384 | 45 1967 10 | rot transparent <i>rouge transparent</i> Ø 9.5 x 38.5 cm | 1 |  | 20.04 | 21.58 |
| |  7 611038 087029 | 45 1967 16 | anthrazit transparent <i>anthracite transparent</i> Ø 9.5 x 38.5 cm | 1 |  | 20.04 | 21.58 |
| |  7 611038 021146 | 45 1967 17 | blau transparent <i>bleu transparent</i> Ø 9.5 x 38.5 cm | 1 |  | 20.04 | 21.58 |
| |  7 611038 137076 | 45 1967 21 | kirsche transparent <i>cerise transparent</i> Ø 9.5 x 38.5 cm | 1 |  | 20.04 | 21.58 |
| |  7 611038 141752 | 45 1967 30 | emerald grün transparent <i>emerald vert transparent</i> Ø 9.5 x 38.5 cm | 1 |  | 20.04 | 21.58 |

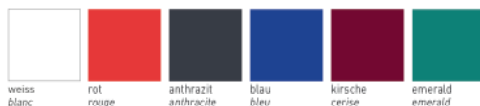

WC-Ersatzbürstenkopf

Brosse de rechange

| | | | | | | |
|--|-------------------|-----------------------------------|-----|---|-------------|-------------|
|  7 611038 116583 | 45 9998 98 | weiss <i>blanc</i> Ø 80 mm | 100 |  | 8.39 | 9.03 |
|  7 611038 116590 | 45 9999 98 | schwarz <i>noir</i> Ø 80 mm | 100 |  | 8.39 | 9.03 |

TREND FROSTED

| EAN-Nr. no EAN | Artikel Nr. no d'article | Beschreibung description | VPE ce | VE ue | UVP pro Stk. PVC CHF excl. | UVP pro Stk. PVC CHF incl. |
|-------------------|-----------------------------|-----------------------------|-----------|----------|----------------------------------|----------------------------------|
|-------------------|-----------------------------|-----------------------------|-----------|----------|----------------------------------|----------------------------------|

Seifenspender Trend Frosted

Distrib. savon Trend Frosted



Polypropylen
Polypropylène

| | | | | | | |
|--|-------------------|--|---|--|-------------|-------------|
| | 45 1751 09 | weiss transparent <i>blanc transparent</i> Ø 6.8 x 15.8 cm | 1 | | 6.99 | 7.53 |
| | 45 1751 10 | rot transparent <i>rouge transparent</i> Ø 6.8 x 15.8 cm | 1 | | 6.99 | 7.53 |
| | 45 1751 16 | anthrazit transparent <i>anthracite transparent</i> Ø 6.8 x 15.8 cm | 1 | | 6.99 | 7.53 |
| | 45 1751 17 | blau transparent <i>bleu transparent</i> Ø 6.8 x 15.8 cm | 1 | | 6.99 | 7.53 |
| | 45 1751 21 | kirsche transparent <i>cerise transparent</i> Ø 6.8 x 15.8 cm | 1 | | 6.99 | 7.53 |
| | 45 1751 30 | emerald grün transparent <i>emerald vert transparent</i> Ø 6.8 x 15.8 cm | 1 | | 6.99 | 7.53 |

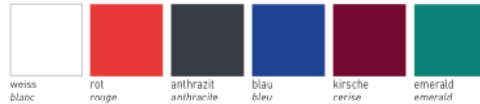

Seifenschale Trend Frosted

Porte-savonnette Trend Frosted



Polypropylen
Polypropylène

| | | | | | | |
|--|-------------------|---|---|--|-------------|-------------|
| | 45 1754 09 | weiss transparent <i>blanc transparent</i> 13.5 x 10.1 x 2.8 cm | 1 | | 4.85 | 5.22 |
| | 45 1754 10 | rot transparent <i>rouge transparent</i> 13.5 x 10.1 x 2.8 cm | 1 | | 4.85 | 5.22 |
| | 45 1754 16 | anthrazit transparent <i>anthracite transparent</i> 13.5 x 10.1 x 2.8 cm | 1 | | 4.85 | 5.22 |
| | 45 1754 21 | kirsche transparent <i>cerise transparent</i> 13.5 x 10.1 x 2.8 cm | 1 | | 4.85 | 5.22 |
| | 45 1754 30 | emerald grün transparent <i>emerald vert transparent</i> 13.5 x 10.1 x 2.8 cm | 1 | | 4.85 | 5.22 |



TREND FROSTED

| EAN-Nr. no EAN | Artikel Nr. no d'article | Beschreibung description | VPE ce | VE ue | UVP pro Stk. PVC CHF excl. | UVP pro Stk. PVC CHF incl. |
|-------------------|-----------------------------|-----------------------------|-----------|----------|----------------------------------|----------------------------------|
|-------------------|-----------------------------|-----------------------------|-----------|----------|----------------------------------|----------------------------------|

Mundspülbecher Trend Frosted

Gobelet à dents Trend Frosted



Polypropylen
Polypropylène

| | | | | | | |
|--|-------------------|--|---|--|-------------|-------------|
| | 45 1752 09 | weiss transparent <i>blanc transparent</i> Ø 6.8 x 10 cm | 1 | | 3.36 | 3.61 |
| | 45 1752 10 | rot transparent <i>rouge transparent</i> Ø 6.8 x 10 cm | 1 | | 3.36 | 3.61 |
| | 45 1752 16 | anthrazit transparent <i>anthracite transparent</i> Ø 6.8 x 10 cm | 1 | | 3.36 | 3.61 |
| | 45 1752 17 | blau transparent <i>bleu transparent</i> Ø 6.8 x 10 cm | 1 | | 3.36 | 3.61 |
| | 45 1752 21 | kirsche transparent <i>cerise transparent</i> Ø 6.8 x 10 cm | 1 | | 3.36 | 3.61 |
| | 45 1752 30 | emerald grün transparent <i>emerald vert transparent</i> Ø 6.8 x 10 cm | 1 | | 3.36 | 3.61 |



Kosmetikdose Trend Frosted

Boîte cosmétique Trend Frosted



Polypropylen
Polypropylène

| | | | | | | |
|--|-------------------|---|---|--|-------------|-------------|
| | 45 1756 09 | weiss transparent <i>blanc transparente</i> Ø 9.5 x 8.9 cm | 1 | | 6.99 | 7.53 |
| | 45 1756 10 | rot transparent <i>rouge transparente</i> Ø 9.5 x 8.9 cm | 1 | | 6.99 | 7.53 |
| | 45 1756 16 | anthrazit transparent <i>anthracite transparent</i> Ø 9.5 x 8.9 cm | 1 | | 6.99 | 7.53 |
| | 45 1756 21 | kirsche transparent <i>cerise transparente</i> Ø 9.5 x 8.9 cm | 1 | | 6.99 | 7.53 |
| | 45 1756 30 | emerald grün transparent <i>emerald vert transparent</i> Ø 9.5 x 8.9 cm | 1 | | 6.99 | 7.53 |



TREND FROSTED









| EAN-Nr. no EAN | Artikel Nr. no d'article | Beschreibung description | VPE ce | VE ue | UVP pro Stk. PVC CHF excl. | UVP pro Stk. PVC CHF incl. |
|-------------------|-----------------------------|-----------------------------|-----------|----------|----------------------------------|----------------------------------|
|-------------------|-----------------------------|-----------------------------|-----------|----------|----------------------------------|----------------------------------|

Papiertuchspend. Trend Frosted

Distributeur de serviettes



Polypropylen
Polypropylène

| | | | | | | |
|---|-------------------|---|---|---|--------------|--------------|
|  7 611038 050788 | 45 1245 09 | weiss transparent <i>blanc transparente</i> 25.5 x 13.5 x 8.5 cm | 1 |  | 13.33 | 14.35 |
|  7 611038 086961 | 45 1245 16 | anthrazit transparent <i>anthracite transparent</i> 25.5 x 13.5 x 8.5 cm | 1 |  | 13.33 | 14.35 |
|  7 611038 137137 | 45 1245 21 | kirsche transparent <i>cerise transparente</i> 25.5 x 13.5 x 8.5 cm | 1 |  | 14.45 | 15.56 |
|  7 611038 141813 | 45 1245 30 | emerald grün transparent <i>emerald vert transparent</i> 25.5 x 13.5 x 8.5 cm | 1 |  | 14.45 | 15.56 |















Nagelbürste Trend Frosted

Brosse à ongles Trend Frosted



Polypropylen
Polypropylène

| | | | | | | |
|---|-------------------|---|---|---|-------------|-------------|
|  7 611038 050825 | 45 2434 09 | weiss transparent <i>blanc transparente</i> 8 x 3.5 x 3.5 cm | 1 |  | 6.06 | 6.52 |
|  7 611038 085209 | 45 2434 10 | rot transparent <i>rouge transparente</i> 8 x 3.5 x 3.5 cm | 1 |  | 6.06 | 6.52 |
|  7 611038 087050 | 45 2434 16 | anthrazit transparent <i>anthracite transparent</i> 8 x 3.5 x 3.5 cm | 1 |  | 6.06 | 6.52 |
|  7 611038 050849 | 45 2434 17 | blau transparent <i>bleu transparente</i> 8 x 3.5 x 3.5 cm | 1 |  | 6.06 | 6.52 |
|  7 611038 137144 | 45 2434 21 | kirsche transparent <i>cerise transparente</i> 8 x 3.5 x 3.5 cm | 1 |  | 6.06 | 6.52 |
|  7 611038 141820 | 45 2434 30 | emerald grün transparent <i>emerald vert transparent</i> 8 x 3.5 x 3.5 cm | 1 |  | 6.06 | 6.52 |



TREND FROSTED

| EAN-Nr. no EAN | Artikel Nr. no d'article | Beschreibung description | VPE ce | VE ue | UVP pro Stk. PVC CHF excl. | UVP pro Stk. PVC CHF incl. |
|-------------------|-----------------------------|-----------------------------|-----------|----------|----------------------------------|----------------------------------|
|-------------------|-----------------------------|-----------------------------|-----------|----------|----------------------------------|----------------------------------|

Schwingdeckeleim.Trend Frosted

Poubelle cosm. Trend Frosted



Polypropylen
Polypropylène

| | | | | | | |
|--|-------------------|--|---|--|--------------|--------------|
| | 45 1968 09 | klein, weiss transparent <i>petit, blanc transparent</i> 2L ; Ø 13.5 x 20 cm | 1 | | 13.33 | 14.35 |
| | 45 1968 10 | klein, rot transparent <i>petite, rouge transparent</i> 2L ; Ø 13.5 x 20 cm | 1 | | 13.33 | 14.35 |
| | 45 1968 16 | klein, anthrazit transparent <i>petite, anthracite transparent</i> 2L ; Ø 13.5 x 20 cm | 1 | | 13.33 | 14.35 |
| | 45 1968 21 | klein, kirsche transparent <i>petite, cerise transparent</i> 2L ; Ø 13.5 x 20 cm | 1 | | 13.33 | 14.35 |
| | 45 1968 30 | klein, emerald grün transparent <i>petit, emerald vert transparent</i> 2L ; Ø 13.5 x 20 cm | 1 | | 13.33 | 14.35 |



Schwingdeckeleim.Trend Frosted

Poubelle cosm. Trend Frosted



Polypropylen
Polypropylène

| | | | | | | |
|--|-------------------|---|---|--|--------------|--------------|
| | 45 1969 09 | gross, weiss transparent <i>grande, blanc transparent</i> 5 l ; Ø 19 x 32 cm | 1 | | 16.50 | 17.77 |
| | 45 1969 10 | gross, rot transparent <i>grande, rouge transparent</i> 5 l ; Ø 19 x 32 cm | 1 | | 16.50 | 17.77 |
| | 45 1969 16 | gross, anthrazit transparent <i>grande, anthracite transparent</i> 5 l ; Ø 19 x 32 cm | 1 | | 16.50 | 17.77 |
| | 45 1969 21 | gross, kirsche transparent <i>grande, cerise transparent</i> 5 l ; Ø 19 x 32 cm | 1 | | 16.50 | 17.77 |





CEMENT

| | EAN-Nr. no EAN | Artikel Nr. no d'article | Beschreibung description | VPE ce | VE ue | UVP pro Stk. PVC CHF excl. | UVP pro Stk. PVC CHF incl. |
|--|-------------------|-----------------------------|-----------------------------|-----------|----------|----------------------------------|----------------------------------|
|--|-------------------|-----------------------------|-----------------------------|-----------|----------|----------------------------------|----------------------------------|

WC-Bürstengarnitur Cement

Garniture de WC Cement







| | | | | | | |
|--|-------------------|---|---|---|--------------|--------------|
|  7 611038 163662 | 48 2208 01 | zement cément 10.5 x 10.5 x 38.5 cm | 1 |  | 54.05 | 58.22 |
|--|-------------------|---|---|---|--------------|--------------|

Zement
Cément

WC-Ersatzbürstenkopf

Brosse de rechange

| | | | | | | |
|--|-------------------|----------------------------|-----|---|-------------|-------------|
|  7 611038 116569 | 45 9996 98 | weiss blanc Ø 70 mm | 100 |  | 8.39 | 9.03 |
|  7 611038 116576 | 45 9997 98 | schwarz noir Ø 70 mm | 100 |  | 8.39 | 9.03 |

Seifenspender Cement

Distributeur de savon Cement





| | | | | | | |
|--|-------------------|-----------------------------------|---|---|--------------|--------------|
|  7 611038 163648 | 48 2208 02 | zement cément 7 x 7 x 17 cm | 1 |  | 24.70 | 26.60 |
|--|-------------------|-----------------------------------|---|---|--------------|--------------|

Zement
Cément

Seifenschale Cement

Porte-savonnette Cement



| | | | | | | |
|--|-------------------|--|---|---|--------------|--------------|
|  7 611038 163655 | 48 2208 04 | zement cément 13.5 x 10.5 x 2.5 cm | 1 |  | 16.31 | 17.57 |
|--|-------------------|--|---|---|--------------|--------------|

Zement
Cément

CEMENT

| EAN-Nr. <i>no EAN</i> | Artikel Nr. <i>no d'article</i> | Beschreibung <i>description</i> | VPE <i>ce</i> | VE <i>ue</i> | UVP pro Stk. <i>PVC</i> CHF excl. | UVP pro Stk. <i>PVC</i> CHF incl. |
|--------------------------|------------------------------------|------------------------------------|------------------|-----------------|---|---|
|--------------------------|------------------------------------|------------------------------------|------------------|-----------------|---|---|

Mundspülbecher Cement

Gobelet à dents Cement



48 2208 03

zement
cément
7 x 7 x 11 cm

1



19.11

20.58

Zement
Cément

ZYLO













| EAN-Nr. no EAN | Artikel Nr. no d'article | Beschreibung description | VPE ce | VE ue | UVP pro Stk. PVC CHF excl. | UVP pro Stk. PVC CHF incl. |
|-------------------|-----------------------------|-----------------------------|-----------|----------|----------------------------------|----------------------------------|
|-------------------|-----------------------------|-----------------------------|-----------|----------|----------------------------------|----------------------------------|

WC-Bürstengarnitur Zylo

Garniture de WC Zylo





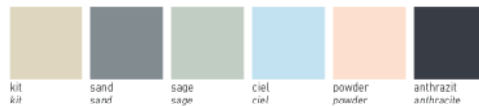

Keramik
Céramique

| | | | | | | |
|---|-------------------|---|---|---|--------------|--------------|
|  | 45 1923 32 | kit - inox Ø 10.5 x 39 cm | 8 |  | 54.99 | 59.22 |
|  | 45 1923 33 | sand - inox Ø 10.5 x 39 cm | 8 |  | 54.99 | 59.22 |
|  | 45 1923 34 | sage - inox Ø 10.5 x 39 cm | 8 |  | 54.99 | 59.22 |
|  | 45 1923 35 | ciel - inox Ø 10.5 x 39 cm | 8 |  | 54.99 | 59.22 |
|  | 45 1923 36 | powder - inox Ø 10.5 x 39 cm | 8 |  | 54.99 | 59.22 |
|  | 45 1923 57 | anthrazit - inox anthracite - inox Ø 10.5 x 39 cm | 8 |  | 54.99 | 59.22 |



WC-Ersatzbürstenkopf

Brosse de rechange

| | | | | | | |
|---|-------------------|----------------------------|-----|---|-------------|-------------|
|  | 45 9996 98 | weiss blanc Ø 70 mm | 100 |  | 8.39 | 9.03 |
|  | 45 9997 98 | schwarz noir Ø 70 mm | 100 |  | 8.39 | 9.03 |

ZYLO

| EAN-Nr. no EAN | Artikel Nr. no d'article | Beschreibung description | VPE ce | VE ue | UVP pro Stk. PVC CHF excl. | UVP pro Stk. PVC CHF incl. |
|-------------------|-----------------------------|-----------------------------|-----------|----------|----------------------------------|----------------------------------|
|-------------------|-----------------------------|-----------------------------|-----------|----------|----------------------------------|----------------------------------|

Seifenspender Zylo

Distributeur de savon Zylo



Keramik
Céramique

| | | | | | | |
|--|-------------------|--|---|--|--------------|--------------|
| | 45 1924 32 | kit - inox Ø 7.2 x 17.5 cm | 1 | | 25.63 | 27.60 |
| | 45 1924 33 | sand - inox Ø 7.2 x 17.5 cm | 1 | | 25.63 | 27.60 |
| | 45 1924 34 | sage - inox Ø 7.2 x 17.5 cm | 1 | | 25.63 | 27.60 |
| | 45 1924 35 | ciel - inox Ø 7.2 x 17.5 cm | 1 | | 25.63 | 27.60 |
| | 45 1924 36 | powder - inox Ø 7.2 x 17.5 cm | 1 | | 25.63 | 27.60 |
| | 45 1924 57 | anthrazit - inox anthracite - inox Ø 7.2 x 17.5 cm | 1 | | 25.63 | 27.60 |

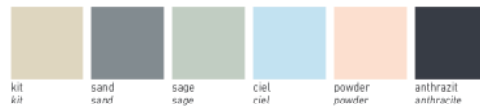

Seifenschale Zylo

Porte-savonnette Zylo







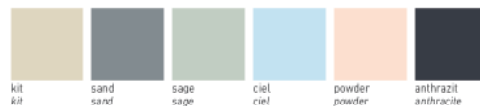







Keramik
Céramique

| | | | | | | |
|--|-------------------|--|---|--|--------------|--------------|
| | 45 1926 32 | kit - inox Ø 11.5 x 3 cm | 1 | | 16.22 | 17.46 |
| | 45 1926 33 | sand - inox Ø 11.5 x 3 cm | 1 | | 16.22 | 17.46 |
| | 45 1926 34 | sage - inox Ø 11.5 x 3 cm | 1 | | 16.22 | 17.46 |
| | 45 1926 35 | ciel - inox Ø 11.5 x 3 cm | 1 | | 16.22 | 17.46 |
| | 45 1926 36 | powder - inox Ø 11.5 x 3 cm | 1 | | 16.22 | 17.46 |
| | 45 1926 57 | anthrazit - inox anthracite - inox Ø 11.5 x 3 cm | 1 | | 16.22 | 17.46 |









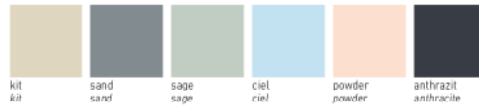





ZYLO

| EAN-Nr. no EAN | Artikel Nr. no d'article | Beschreibung description | VPE ce | VE ue | UVP pro Stk. PVC CHF excl. | UVP pro Stk. PVC CHF incl. |
|-------------------|-----------------------------|-----------------------------|-----------|----------|----------------------------------|----------------------------------|
|-------------------|-----------------------------|-----------------------------|-----------|----------|----------------------------------|----------------------------------|

| Mundspülbecher Zylo | | Gobelet à dents Zylo | | | | | |
|--|---|----------------------|--|---|---|--------------|--------------|
|  <p>Keramik Céramique</p> |  | 45 1925 32 | kit - inox Ø 7.2 x 11 cm | 1 |  | 17.52 | 18.87 |
| |  | 45 1925 33 | sand - inox Ø 7.2 x 11 cm | 1 |  | 17.52 | 18.87 |
| |  | 45 1925 34 | sage - inox Ø 7.2 x 11 cm | 1 |  | 17.52 | 18.87 |
| |  | 45 1925 35 | ciel - inox Ø 7.2 x 11 cm | 1 |  | 17.52 | 18.87 |
| |  | 45 1925 36 | powder - inox Ø 7.2 x 11 cm | 1 |  | 17.52 | 18.87 |
| |  | 45 1925 57 | anthrazit - inox anthracite - inox Ø 7.2 x 11 cm | 1 |  | 17.52 | 18.87 |



| Kosmetikdose Zylo | | Boîte cosmétique Zylo | | | | | |
|--|---|-----------------------|---|---|---|--------------|--------------|
|  <p>Keramik Céramique</p> |  | 45 1927 32 | kit - inox Ø 10.7 x 12 cm | 1 |  | 30.75 | 33.12 |
| |  | 45 1927 33 | sand - inox Ø 10.7 x 12 cm | 1 |  | 30.75 | 33.12 |
| |  | 45 1927 34 | sage - inox Ø 10.7 x 12 cm | 1 |  | 30.75 | 33.12 |
| |  | 45 1927 35 | ciel - inox Ø 10.7 x 12 cm | 1 |  | 30.75 | 33.12 |
| |  | 45 1927 36 | powder - inox Ø 10.7 x 12 cm | 1 |  | 30.75 | 33.12 |
| |  | 45 1927 57 | anthrazit - inox anthracite - inox Ø 10.7 x 12 cm | 1 |  | 30.75 | 33.12 |

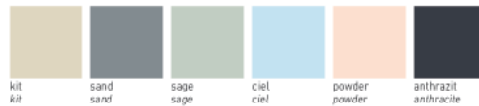

ZYLO

| EAN-Nr. no EAN | Artikel Nr. no d'article | Beschreibung description | VPE ce | VE ue | UVP pro Stk. PVC CHF excl. | UVP pro Stk. PVC CHF incl. |
|-------------------|-----------------------------|-----------------------------|-----------|----------|----------------------------------|----------------------------------|
|-------------------|-----------------------------|-----------------------------|-----------|----------|----------------------------------|----------------------------------|

WC-Sitz Hollywood Slow Down

Siège WC Hollywood Slow Down

| | | | | | | | |
|---|--|-------------------|--|---|---|--------------|--------------|
|  |  7 611038 166663 | 31 1679 32 | kit 41.5-45 x 38.2 cm ; 10 | 4 |  | 81.08 | 87.32 |
| |  7 611038 166656 | 31 1679 33 | smoke 41.5-45 x 38.2 cm ; 10 | 4 |  | 81.08 | 87.32 |
| |  7 611038 166670 | 31 1679 34 | sage 41.5-45 x 38.2 cm ; 10 | 4 |  | 81.08 | 87.32 |
| |  7 611038 166687 | 31 1679 35 | ciel 41.5-45 x 38.2 cm ; 10 | 4 |  | 81.08 | 87.32 |
| |  7 611038 166694 | 31 1679 36 | powder 41.5-45 x 38.2 cm ; 10 | 4 |  | 81.08 | 87.32 |
| |  7 611038 166700 | 31 1679 41 | weiss blanc 41.5-45 x 38.2 cm ; 10 | 4 |  | 81.08 | 87.32 |
| |  7 611038 166649 | 31 1679 58 | gray gris 41.5-45 x 38.2 cm ; 10 | 4 |  | 81.08 | 87.32 |

aus Duroplast
mit Absenkautomatik
Ringfarbe: weiss
en plastique dur
abaissement automatique
couleur de la lunette: blanc

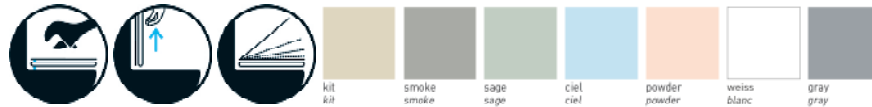

MIX & MATCH





| EAN-Nr. no EAN | Artikel Nr. no d'article | Beschreibung description | VPE ce | VE ue | UVP pro Stk. PVC CHF excl. | UVP pro Stk. PVC CHF incl. |
|-------------------|-----------------------------|-----------------------------|-----------|----------|----------------------------------|----------------------------------|
|-------------------|-----------------------------|-----------------------------|-----------|----------|----------------------------------|----------------------------------|

WC-Bürstengarnitur Mix & Match

Garniture de WC Mix & Match







Keramik
Céramique

| | | | | | | |
|--|-------------------|--------------------------------|---|---|--------------|--------------|
|  7 611038 164478 | 48 2240 41 | weiss blanc Ø 8 x 40 cm | 1 |  | 38.68 | 41.65 |
|  7 611038 164546 | 48 2240 80 | schwarz noir Ø 8 x 40 cm | 1 |  | 38.68 | 41.65 |



WC-Ersatzbürstenkopf

Brosse de rechange





| | | | | | | |
|--|-------------------|----------------------------|-----|---|-------------|-------------|
|  7 611038 116569 | 45 9996 98 | weiss blanc Ø 70 mm | 100 |  | 8.39 | 9.03 |
|  7 611038 116576 | 45 9997 98 | schwarz noir Ø 70 mm | 100 |  | 8.39 | 9.03 |

Seifenspender Mix & Match

Distributeur savon Mix & Match



Keramik
Céramique

| | | | | | | |
|--|-------------------|----------------------------------|---|---|--------------|--------------|
|  7 611038 164454 | 48 2241 41 | weiss blanc Ø 7.5 x 17 cm | 1 |  | 24.70 | 26.60 |
|  7 611038 164522 | 48 2241 80 | schwarz noir Ø 7.5 x 17 cm | 1 |  | 24.70 | 26.60 |







Mundspülbecher Mix & Match

Gobelet à dents Mix & Match



Keramik
Céramique

| | | | | | | |
|--|-------------------|----------------------------------|---|---|--------------|--------------|
|  7 611038 164447 | 48 2242 41 | weiss blanc Ø 7.5 x 11 cm | 1 |  | 17.71 | 19.07 |
|  7 611038 164508 | 48 2242 80 | schwarz noir Ø 7.5 x 11 cm | 1 |  | 17.71 | 19.07 |



MIX & MATCH

| EAN-Nr. <i>no EAN</i> | Artikel Nr. <i>no d'article</i> | Beschreibung <i>description</i> | VPE <i>ce</i> | VE <i>ue</i> | UVP pro Stk. <i>PVC</i> CHF excl. | UVP pro Stk. <i>PVC</i> CHF incl. |
|--------------------------|------------------------------------|------------------------------------|------------------|-----------------|---|---|
|--------------------------|------------------------------------|------------------------------------|------------------|-----------------|---|---|

| | |
|-------------------------------------|---|
| Kosmetikdose Mix & Match | Boîte cosmétique Mix & Match |
|-------------------------------------|---|



Keramik
Céramique

| | | | | | | |
|--|-------------------|--|---|---|--------------|--------------|
|  7 611038 164485 | 48 2245 41 | weiss - klein <i>blanc - petite</i> Ø 7.5 x 12.5 cm | 1 |  | 21.43 | 23.09 |
|  7 611038 164553 | 48 2245 80 | schwarz - klein <i>noir - petite</i> Ø 7.5 x 12.5 cm | 1 |  | 21.43 | 23.09 |



ARDEZIO

| | EAN-Nr. no EAN | Artikel Nr. no d'article | Beschreibung description | VPE ce | VE ue | UVP pro Stk. PVC CHF excl. | UVP pro Stk. PVC CHF incl. |
|--|-------------------|-----------------------------|-----------------------------|-----------|----------|----------------------------------|----------------------------------|
|--|-------------------|-----------------------------|-----------------------------|-----------|----------|----------------------------------|----------------------------------|

WC-Bürstengarnitur Ardezio





Garniture de WC Ardezio



| | | | | | | |
|--|-------------------|--|---|---|--------------|--------------|
|  7 611038 246297 | 48 2319 00 | Schiefer ardoise 10 x 10 x 37.5 cm | 4 |  | 37.28 | 40.15 |
|--|-------------------|--|---|---|--------------|--------------|

WC-Ersatzbürstenkopf



Brosse de rechange

| | | | | | | |
|--|-------------------|----------------------------|-----|---|-------------|-------------|
|  7 611038 116583 | 45 9998 98 | weiss blanc Ø 80 mm | 100 |  | 8.39 | 9.03 |
|  7 611038 116590 | 45 9999 98 | schwarz noir Ø 80 mm | 100 |  | 8.39 | 9.03 |

Seifenspender Ardezio



Distributeur Savon Ardezio



| | | | | | | |
|--|-------------------|--|---|---|--------------|--------------|
|  7 611038 246303 | 48 2319 01 | Schiefer ardoise 7.1 x 7.1 x 16.3 cm | 1 |  | 31.69 | 34.13 |
|--|-------------------|--|---|---|--------------|--------------|

Ersatzpumpe Ardezio



Pompe de rechange

| | | | | | | |
|--|-------------------|---------------------|---|---|--------------|--------------|
|  7 611038 192037 | 48 2319 96 | satiniert satiné | 1 |  | 11.09 | 11.94 |
|--|-------------------|---------------------|---|---|--------------|--------------|

Mundspülbecher Ardezio

Gobelet à dents Ardezio



| | | | | | | |
|--|-------------------|--------------------------------------|---|---|--------------|--------------|
|  7 611038 246310 | 48 2319 02 | Schiefer ardoise 7 x 7 x 11 cm | 4 |  | 23.76 | 25.59 |
|--|-------------------|--------------------------------------|---|---|--------------|--------------|

ARDEZIO

| | EAN-Nr. <i>no EAN</i> | Artikel Nr. <i>no d'article</i> | Beschreibung <i>description</i> | VPE <i>ce</i> | VE <i>ue</i> | UVP pro Stk. <i>PVC</i> CHF excl. | UVP pro Stk. <i>PVC</i> CHF incl. |
|--|--------------------------|------------------------------------|------------------------------------|------------------|-----------------|---|---|
|--|--------------------------|------------------------------------|------------------------------------|------------------|-----------------|---|---|

Seifenschale Ardezio

Porte-savonette Ardezio



48 2319 03

Schiefer
ardoise
13.8 x 1.3 x 9.5 cm

1



20.97

22.58

Kosmetikdose Ardezio

Boîte cosmétique Ardezio



48 2319 04

Schiefer
ardoise
7 x 7 x 11 cm

1



24.70

26.60

ETOSHA



| EAN-Nr. no EAN | Artikel Nr. no d'article | Beschreibung description | VPE ce | VE ue | UVP pro Stk. PVC CHF excl. | UVP pro Stk. PVC CHF incl. |
|-------------------|-----------------------------|-----------------------------|-----------|----------|----------------------------------|----------------------------------|
|-------------------|-----------------------------|-----------------------------|-----------|----------|----------------------------------|----------------------------------|

WC-Bürstengarnitur Etosha

Garniture de WC Etosha







Zement
Cément

| | | | | | | |
|--|-------------------|------------------------------|---|---|--------------|--------------|
|  7 611038 246532 | 48 2325 00 | braun brun Ø 9 x 40 cm | 4 |  | 41.01 | 44.16 |
|--|-------------------|------------------------------|---|---|--------------|--------------|

WC-Ersatzbürstenkopf

Brosse de rechange



| | | | | | | |
|--|-------------------|----------------------------|---|---|-------------|-------------|
|  7 611038 181468 | 45 9993 98 | weiss blanc Ø 75 mm | 1 |  | 8.95 | 9.64 |
|  7 611038 181451 | 45 9994 98 | schwarz noir Ø 75 mm | 1 |  | 8.95 | 9.64 |

Seifenspender Etosha

Distributeur Savon Etosha



Zement
Cément



| | | | | | | |
|--|-------------------|----------------------------------|---|---|--------------|--------------|
|  7 611038 246549 | 48 2325 01 | braun brun Ø 6.5 x 16.5 cm | 4 |  | 21.90 | 23.59 |
|--|-------------------|----------------------------------|---|---|--------------|--------------|

Mundspülbecher Etosha

Gobelet à dents Etosha



Zement
Cément

| | | | | | | |
|--|-------------------|----------------------------------|---|---|--------------|--------------|
|  7 611038 246556 | 48 2325 02 | braun brun Ø 6.5 x 11.2 cm | 1 |  | 19.11 | 20.58 |
|--|-------------------|----------------------------------|---|---|--------------|--------------|

ETOSHA

| | EAN-Nr. <i>no EAN</i> | Artikel Nr. <i>no d'article</i> | Beschreibung <i>description</i> | VPE <i>ce</i> | VE <i>ue</i> | UVP pro Stk. <i>PVC</i> CHF excl. | UVP pro Stk. <i>PVC</i> CHF incl. |
|--|--------------------------|------------------------------------|------------------------------------|------------------|-----------------|---|---|
|--|--------------------------|------------------------------------|------------------------------------|------------------|-----------------|---|---|

Seifenschale Etosha

Porte-savonette Etosha



48 2325 03

braun
brun
Ø 12.5 x 2.5 cm

4



16.22

17.46

Zement
Cément

Kosmetikdose Etosha

Boîte cosmétique Etosha



48 2325 04

braun
brun
Ø 10.5 x 11 cm

1



29.82

32.12

Zement
Cément

SWEET HOME



| EAN-Nr. no EAN | Artikel Nr. no d'article | Beschreibung description | VPE ce | VE ue | UVP pro Stk. PVC CHF excl. | UVP pro Stk. PVC CHF incl. |
|-------------------|-----------------------------|-----------------------------|-----------|----------|----------------------------------|----------------------------------|
|-------------------|-----------------------------|-----------------------------|-----------|----------|----------------------------------|----------------------------------|

WC-Bürstengarn. Sweet Home

Garniture de WC Sweet Home







Keramik
Céramique

| | | | | | | |
|--|-------------------|----------------------------------|---|---|--------------|--------------|
|  7 611038 180690 | 48 2316 00 | weiss blanc Ø 11.5 x 38 cm | 6 |  | 37.28 | 40.15 |
|--|-------------------|----------------------------------|---|---|--------------|--------------|

WC-Ersatzbürstenkopf

Brosse de rechange



| | | | | | | |
|--|-------------------|----------------------------|---|---|-------------|-------------|
|  7 611038 181468 | 45 9993 98 | weiss blanc Ø 75 mm | 1 |  | 8.95 | 9.64 |
|  7 611038 181451 | 45 9994 98 | schwarz noir Ø 75 mm | 1 |  | 8.95 | 9.64 |

Seifenspender Sweet Home

Distributeur Savon Sweet Home



Keramik
Céramique



| | | | | | | |
|--|-------------------|-----------------------------------|---|---|--------------|--------------|
|  7 611038 180706 | 48 2316 01 | weiss blanc Ø 8.5 x 17.5 cm | 4 |  | 20.04 | 21.58 |
|--|-------------------|-----------------------------------|---|---|--------------|--------------|

Mundspülbecher Sweet Home

Gobelet à dents Sweet Home



Keramik
Céramique

| | | | | | | |
|--|-------------------|-----------------------------------|---|---|--------------|--------------|
|  7 611038 180713 | 48 2316 02 | weiss blanc Ø 8.5 x 12.5 cm | 4 |  | 14.54 | 15.66 |
|--|-------------------|-----------------------------------|---|---|--------------|--------------|

SWEET HOME

| | EAN-Nr. <i>no EAN</i> | Artikel Nr. <i>no d'article</i> | Beschreibung <i>description</i> | VPE <i>ce</i> | VE <i>ue</i> | UVP pro Stk. <i>PVC</i> CHF excl. | UVP pro Stk. <i>PVC</i> CHF incl. |
|--|--------------------------|------------------------------------|------------------------------------|------------------|-----------------|---|---|
|--|--------------------------|------------------------------------|------------------------------------|------------------|-----------------|---|---|

Seifenschale Sweet Home

Porte-savonette Sweet Home



48 2316 03

weiss
blanc
Ø 14 x 3.5 cm

4



14.82

15.96

Keramik
Céramique

Kosmetikdose Sweet Home

Boîte cosmétique Sweet Home



48 2316 04

weiss
blanc
Ø 13.9 x 15.5 cm

4



23.30

25.09

Keramik
Céramique

Dekorbadewanne Sweet Home

Baignoire déco Sweet Home



48 2316 05

weiss
blanc
24.5 x 11.5 x 13.5 cm

4



32.15

34.63

Keramik
Céramique

MARINA



| EAN-Nr. no EAN | Artikel Nr. no d'article | Beschreibung description | VPE ce | VE ue | UVP pro Stk. PVC CHF excl. | UVP pro Stk. PVC CHF incl. |
|-------------------|-----------------------------|-----------------------------|-----------|----------|----------------------------------|----------------------------------|
|-------------------|-----------------------------|-----------------------------|-----------|----------|----------------------------------|----------------------------------|

WC-Bürstengarnitur Marina

Garniture de WC Marina







Keramik
Céramique

| | | | | | | |
|--|-------------------|--|---|---|--------------|--------------|
|  7 611038 246389 | 48 2321 00 | weiss/blau blanc/bleu Ø 11 x 39 cm | 1 |  | 37.28 | 40.15 |
|--|-------------------|--|---|---|--------------|--------------|

WC-Ersatzbürstenkopf

Brosse de rechange



| | | | | | | |
|--|-------------------|----------------------------|-----|---|-------------|-------------|
|  7 611038 116569 | 45 9996 98 | weiss blanc Ø 70 mm | 100 |  | 8.39 | 9.03 |
|  7 611038 116576 | 45 9997 98 | schwarz noir Ø 70 mm | 100 |  | 8.39 | 9.03 |

Seifenspender Marina

Distributeur Savon Marina



Keramik
Céramique

| | | | | | | |
|--|-------------------|---|---|---|--------------|--------------|
|  7 611038 246396 | 48 2321 01 | weiss/blau blanc/bleu Ø 7.4 x 19 cm | 1 |  | 20.97 | 22.58 |
|--|-------------------|---|---|---|--------------|--------------|

Mundspülbecher Marina

Gobelet à dents Marina



Keramik
Céramique

| | | | | | | |
|--|-------------------|---|---|---|--------------|--------------|
|  7 611038 246402 | 48 2321 02 | weiss/blau blanc/bleu Ø 7.3 x 10.3 cm | 1 |  | 12.58 | 13.55 |
|--|-------------------|---|---|---|--------------|--------------|



MARINA

| | EAN-Nr. <i>no EAN</i> | Artikel Nr. <i>no d'article</i> | Beschreibung <i>description</i> | VPE <i>ce</i> | VE <i>ue</i> | UVP pro Stk. <i>PVC</i> CHF excl. | UVP pro Stk. <i>PVC</i> CHF incl. |
|--|--------------------------|------------------------------------|------------------------------------|------------------|-----------------|---|---|
|--|--------------------------|------------------------------------|------------------------------------|------------------|-----------------|---|---|

Seifenschale Marina

Porte-savonette Marina



| | | | | | | |
|--|-------------------|--|---|---|--------------|--------------|
|  7 611038 246419 | 48 2321 03 | weiss/blau <i>blanc/bleu</i> 13 x 9 x 3 cm | 1 |  | 11.09 | 11.94 |
|--|-------------------|--|---|---|--------------|--------------|

Keramik
Céramique

MARMARA

| EAN-Nr. no EAN | Artikel Nr. no d'article | Beschreibung description | VPE ce | VE ue | UVP pro Stk. PVC CHF excl. | UVP pro Stk. PVC CHF incl. |
|-------------------|-----------------------------|-----------------------------|-----------|----------|----------------------------------|----------------------------------|
|-------------------|-----------------------------|-----------------------------|-----------|----------|----------------------------------|----------------------------------|

WC-Bürstengarnitur Marmara

Garniture de WC Marmara







Keramik
Céramique

| | | | | | | |
|--|-------------------|--|---|---|--------------|--------------|
|  7 611038 246648 | 48 2326 00 | weiss/blau blanc/bleu Ø 10 x 44 cm | 1 |  | 37.28 | 40.15 |
|--|-------------------|--|---|---|--------------|--------------|

WC-Ersatzbürstenkopf

Brosse de rechange



| | | | | | | |
|--|-------------------|----------------------------|---|---|-------------|-------------|
|  7 611038 181468 | 45 9993 98 | weiss blanc Ø 75 mm | 1 |  | 8.95 | 9.64 |
|  7 611038 181451 | 45 9994 98 | schwarz noir Ø 75 mm | 1 |  | 8.95 | 9.64 |

Seifenspender Marmara

Distributeur Savon Marmara



Keramik
Céramique



| | | | | | | |
|--|-------------------|---|---|---|--------------|--------------|
|  7 611038 246655 | 48 2326 01 | weiss/blau blanc/bleu Ø 7.8 x 16 cm | 1 |  | 20.04 | 21.58 |
|--|-------------------|---|---|---|--------------|--------------|

Mundspülbecher Marmara

Gobelet à dents Marmara





Keramik
Céramique



| | | | | | | |
|--|-------------------|---|---|---|--------------|--------------|
|  7 611038 246662 | 48 2326 02 | weiss/blau blanc/bleu Ø 7.8 x 10.5 cm | 1 |  | 12.39 | 13.35 |
|--|-------------------|---|---|---|--------------|--------------|

MARMARA

| | EAN-Nr. <i>no EAN</i> | Artikel Nr. <i>no d'article</i> | Beschreibung <i>description</i> | VPE <i>ce</i> | VE <i>ue</i> | UVP pro Stk. <i>PVC</i> CHF excl. | UVP pro Stk. <i>PVC</i> CHF incl. |
|--|--------------------------|------------------------------------|------------------------------------|------------------|-----------------|---|---|
|--|--------------------------|------------------------------------|------------------------------------|------------------|-----------------|---|---|

| Seifenschale Marmara | | Porte-savonette Marmara | | | | | |
|---|--|-------------------------|--|---|---|--------------|--------------|
|  |  7 611038 246679 | 48 2326 03 | weiss/blau <i>blanc/bleu</i> 13 x 9 x 3 cm | 1 |  | 11.09 | 11.94 |

Keramik
Céramique

| Kosmetikdose Marmara | | Boîte cosmétique Marmara | | | | | |
|---|--|--------------------------|--|---|---|--------------|--------------|
|  |  7 611038 246686 | 48 2326 04 | weiss/blau <i>blanc/bleu</i> Ø 7.8 x 11.5 cm | 1 |  | 16.22 | 17.46 |

Keramik
Céramique

TRILLIUM

| EAN-Nr. no EAN | Artikel Nr. no d'article | Beschreibung description | VPE ce | VE ue | UVP pro Stk. PVC CHF excl. | UVP pro Stk. PVC CHF incl. |
|-------------------|-----------------------------|-----------------------------|-----------|----------|----------------------------------|----------------------------------|
|-------------------|-----------------------------|-----------------------------|-----------|----------|----------------------------------|----------------------------------|

WC-Bürstengarnitur Trillium

Garniture de WC Trillium







Keramik
Céramique

| | | | | | | |
|--|-------------------|---|---|---|--------------|--------------|
|  7 611038 246259 | 48 2318 00 | weiss/schwarz blanc/noir Ø 11.5 x 39.5 cm | 1 |  | 31.69 | 34.13 |
|--|-------------------|---|---|---|--------------|--------------|

WC-Ersatzbürstenkopf

Brosse de rechange



| | | | | | | |
|--|-------------------|----------------------------|-----|---|-------------|-------------|
|  7 611038 116583 | 45 9998 98 | weiss blanc Ø 80 mm | 100 |  | 8.39 | 9.03 |
|  7 611038 116590 | 45 9999 98 | schwarz noir Ø 80 mm | 100 |  | 8.39 | 9.03 |

Seifenspender Trillium

Distributeur Savon Trillium



Keramik
Céramique



| | | | | | | |
|--|-------------------|--|---|---|--------------|--------------|
|  7 611038 246266 | 48 2318 01 | weiss/schwarz blanc/noir Ø 7.3 x 16.5 cm | 4 |  | 20.04 | 21.58 |
|--|-------------------|--|---|---|--------------|--------------|

Mundspülbecher Trillium



Gobelet à dents Savon Trillium



Keramik
Céramique

| | | | | | | |
|--|-------------------|--|---|---|--------------|--------------|
|  7 611038 246273 | 48 2318 02 | weiss/schwarz blanc/noir Ø 6.6 x 10 cm | 4 |  | 12.39 | 13.35 |
|--|-------------------|--|---|---|--------------|--------------|

TRILLIUM

| | EAN-Nr. <i>no EAN</i> | Artikel Nr. <i>no d'article</i> | Beschreibung <i>description</i> | VPE <i>ce</i> | VE <i>ue</i> | UVP pro Stk. <i>PVC</i> CHF excl. | UVP pro Stk. <i>PVC</i> CHF incl. |
|---|---|------------------------------------|---|------------------|---|---|---|
| Seifenschale Trillium | | | Porte-savonette Trillium | | | | |
|  |  | 48 2318 03 | weiss/schwarz <i>blanc/noir</i> 13.9 x 2.5 x 9.3 cm | 4 |  | 11.09 | 11.94 |

Keramik
Céramique

GRAPHICS

| | EAN-Nr. <i>no EAN</i> | Artikel Nr. <i>no d'article</i> | Beschreibung <i>description</i> | VPE <i>ce</i> | VE <i>ue</i> | UVP pro Stk. <i>PVC</i> CHF excl. | UVP pro Stk. <i>PVC</i> CHF incl. |
|--|--------------------------|------------------------------------|------------------------------------|------------------|-----------------|---|---|
|--|--------------------------|------------------------------------|------------------------------------|------------------|-----------------|---|---|

WC-Bürstengarnitur Graphics

Garniture de WC Graphics







Keramik
Céramique

| | | | | | | |
|--|-------------------|---|---|---|--------------|--------------|
|  7 611038 246426 | 48 2322 00 | weiss/hellblau <i>blanc/bleu clair</i> Ø 10 x 38 cm | 1 |  | 32.62 | 35.13 |
|--|-------------------|---|---|---|--------------|--------------|

WC-Ersatzbürstenkopf

Brosse de rechange

| | | | | | | |
|--|-------------------|-----------------------------------|-----|---|-------------|-------------|
|  7 611038 116583 | 45 9998 98 | weiss <i>blanc</i> Ø 80 mm | 100 |  | 8.39 | 9.03 |
|  7 611038 116590 | 45 9999 98 | schwarz <i>noir</i> Ø 80 mm | 100 |  | 8.39 | 9.03 |

Seifenspender Graphics

Distributeur Savon Graphics



Keramik
Céramique

| | | | | | | |
|--|-------------------|--|---|---|--------------|--------------|
|  7 611038 246433 | 48 2322 01 | weiss/hellblau <i>blanc/bleu clair</i> Ø 7 x 17.5 cm | 1 |  | 18.64 | 20.07 |
|--|-------------------|--|---|---|--------------|--------------|

Mundspülbecher Graphics



Gobelet à dents Graphics



Keramik
Céramique

| | | | | | | |
|--|-------------------|--|---|---|--------------|--------------|
|  7 611038 246440 | 48 2322 02 | weiss/hellblau <i>blanc/bleu clair</i> Ø 7 x 10.3 cm | 1 |  | 12.39 | 13.35 |
|--|-------------------|--|---|---|--------------|--------------|

GRAPHICS

| | EAN-Nr. <i>no EAN</i> | Artikel Nr. <i>no d'article</i> | Beschreibung <i>description</i> | VPE <i>ce</i> | VE <i>ue</i> | UVP pro Stk. <i>PVC</i> CHF excl. | UVP pro Stk. <i>PVC</i> CHF incl. |
|---|--|------------------------------------|--|------------------|---|---|---|
| Seifenschale Graphics | | Porte-savonette Graphics | | | | | |
|  |  7 611038 246457 | 48 2322 03 | weiss/hellblau <i>blanc/bleu clair</i> 12.5 x 9.5 x 3 cm | 1 |  | 11.18 | 12.04 |

Keramik
Céramique

CIRCLE

| EAN-Nr. <i>no EAN</i> | Artikel Nr. <i>no d'article</i> | Beschreibung <i>description</i> | VPE <i>ce</i> | VE <i>ue</i> | UVP pro Stk. <i>PVC</i> CHF excl. | UVP pro Stk. <i>PVC</i> CHF incl. |
|--------------------------|------------------------------------|------------------------------------|------------------|-----------------|---|---|
|--------------------------|------------------------------------|------------------------------------|------------------|-----------------|---|---|

Seifenspender Circle

Distributeur Savon Circle



| | | | | | | |
|--|-------------------|--|---|---|--------------|--------------|
|  7 611038 246471 | 48 2323 01 | weiss/blau <i>blanc/bleu</i> Ø 7 x 17.3 cm | 1 |  | 17.52 | 18.87 |
|--|-------------------|--|---|---|--------------|--------------|

Keramik
Céramique

Mundspülbecher Circle

Gobelet à dents Circle





| | | | | | | |
|--|-------------------|--|---|---|--------------|--------------|
|  7 611038 246488 | 48 2323 02 | weiss/blau <i>blanc/bleu</i> Ø 7 x 11.5 cm | 1 |  | 11.18 | 12.04 |
|--|-------------------|--|---|---|--------------|--------------|

Keramik
Céramique

Seifenschale Circle

Porte-savonette Circle



| | | | | | | |
|--|-------------------|---|---|---|-------------|-------------|
|  7 611038 246495 | 48 2323 03 | weiss/blau <i>blanc/bleu</i> 13.5 x 3 x 10 cm | 1 |  | 8.71 | 9.38 |
|--|-------------------|---|---|---|-------------|-------------|

Keramik
Céramique

RUEN



| | EAN-Nr. no EAN | Artikel Nr. no d'article | Beschreibung description | VPE ce | VE ue | UVP pro Stk. PVC CHF excl. | UVP pro Stk. PVC CHF incl. |
|--|-------------------|-----------------------------|-----------------------------|-----------|----------|----------------------------------|----------------------------------|
|--|-------------------|-----------------------------|-----------------------------|-----------|----------|----------------------------------|----------------------------------|

WC-Bürstengarnitur Ruen

Garniture de WC Ruen







Keramik
Céramique

| | | | | | | |
|--|-------------------|---|---|---|--------------|--------------|
|  7 611038 248987 | 48 2334 00 | braun/aqua brun/aqua Ø 10.6 x 41 cm | 4 |  | 30.29 | 32.62 |
|--|-------------------|---|---|---|--------------|--------------|

WC-Ersatzbürstenkopf

Brosse de rechange



| | | | | | | |
|--|-------------------|----------------------------|-----|---|-------------|-------------|
|  7 611038 116583 | 45 9998 98 | weiss blanc Ø 80 mm | 100 |  | 8.39 | 9.03 |
|  7 611038 116590 | 45 9999 98 | schwarz noir Ø 80 mm | 100 |  | 8.39 | 9.03 |

Seifenspender Ruen

Distributeur de savon Ruen



Keramik
Céramique



| | | | | | | |
|--|-------------------|--|---|---|--------------|--------------|
|  7 611038 248994 | 48 2334 01 | braun/aqua brun/aqua Ø 7.2 x 18.2 cm | 4 |  | 16.59 | 17.87 |
|--|-------------------|--|---|---|--------------|--------------|

Mundspülbecher Ruen

Gobelet à dents Ruen



Keramik
Céramique

| | | | | | | |
|--|-------------------|--|---|---|--------------|--------------|
|  7 611038 249007 | 48 2334 02 | braun/aqua brun/aqua Ø 7.2 x 12 cm | 4 |  | 13.14 | 14.15 |
|--|-------------------|--|---|---|--------------|--------------|

EMILIA



| | EAN-Nr. no EAN | Artikel Nr. no d'article | Beschreibung description | VPE ce | VE ue | UVP pro Stk. PVC CHF excl. | UVP pro Stk. PVC CHF incl. |
|--|-------------------|-----------------------------|-----------------------------|-----------|----------|----------------------------------|----------------------------------|
|--|-------------------|-----------------------------|-----------------------------|-----------|----------|----------------------------------|----------------------------------|

WC-Bürstengarnitur Emilia

Garniture de WC Emilia







Keramik
Céramique

| | | | | | | |
|--|-------------------|---------------------------------|---|---|--------------|--------------|
|  7 611038 249014 | 48 2335 00 | weiss blanc Ø 9.9 x 35 cm | 4 |  | 33.55 | 36.13 |
|--|-------------------|---------------------------------|---|---|--------------|--------------|

WC-Ersatzbürstenkopf

Brosse de rechange



| | | | | | | |
|--|-------------------|----------------------------|-----|---|-------------|-------------|
|  7 611038 116569 | 45 9996 98 | weiss blanc Ø 70 mm | 100 |  | 8.39 | 9.03 |
|  7 611038 116576 | 45 9997 98 | schwarz noir Ø 70 mm | 100 |  | 8.39 | 9.03 |

Seifenspender Emilia

Distributeur de savon Emilia



Keramik
Céramique



| | | | | | | |
|--|-------------------|---------------------------------|---|---|--------------|--------------|
|  7 611038 249021 | 48 2335 01 | weiss blanc Ø 7 x 20.2 cm | 4 |  | 15.56 | 16.76 |
|--|-------------------|---------------------------------|---|---|--------------|--------------|

Mundspülbecher Emilia

Gobelet à dents Emilia



Keramik
Céramique

| | | | | | | |
|--|-------------------|---------------------------------|---|---|--------------|--------------|
|  7 611038 249038 | 48 2335 02 | weiss blanc Ø 7 x 11.9 cm | 4 |  | 10.72 | 11.54 |
|--|-------------------|---------------------------------|---|---|--------------|--------------|

YUMA















| EAN-Nr. no EAN | Artikel Nr. no d'article | Beschreibung description | VPE ce | VE ue | UVP pro Stk. PVC CHF excl. | UVP pro Stk. PVC CHF incl. |
|-------------------|-----------------------------|-----------------------------|-----------|----------|----------------------------------|----------------------------------|
|-------------------|-----------------------------|-----------------------------|-----------|----------|----------------------------------|----------------------------------|

WC-Bürstengarnitur Yuma

Garniture de WC Yuma



Keramik
Céramique

| | | | | | | |
|---|-------------------|--|---|---|--------------|--------------|
|  7 611038 249052 | 48 2336 42 | weiss matt <i>blanc</i> Ø 11.9 x 39.2 cm | 4 |  | 30.29 | 32.62 |
|  7 611038 249076 | 48 2336 56 | blau matt <i>bleu</i> Ø 11.9 x 39.2 cm | 4 |  | 30.29 | 32.62 |
|  7 611038 249069 | 48 2336 58 | anthrazit matt <i>anthrazit</i> Ø 11.9 x 39.2 cm | 4 |  | 30.29 | 32.62 |
|  7 611038 249083 | 48 2336 70 | gelb matt <i>jaune</i> Ø 11.9 x 39.2 cm | 4 |  | 30.29 | 32.62 |
|  7 611038 249045 | 48 2336 80 | schwarz matt <i>noir</i> Ø 11.9 x 39.2 cm | 4 |  | 30.29 | 32.62 |
|  7 611038 249090 | 48 2336 93 | berry matt <i>berry</i> Ø 11.9 x 39.2 cm | 4 |  | 30.29 | 32.62 |
|  7 611038 249106 | 48 2336 94 | braun matt <i>brun</i> Ø 11.9 x 39.2 cm | 4 |  | 30.29 | 32.62 |

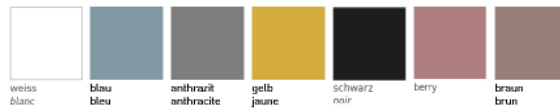

WC-Ersatzbürstenkopf

Brosse de rechange

| | | | | | | |
|--|-------------------|-----------------------------------|---|---|-------------|-------------|
|  7 611038 181468 | 45 9993 98 | weiss <i>blanc</i> Ø 75 mm | 1 |  | 8.95 | 9.64 |
|  7 611038 181451 | 45 9994 98 | schwarz <i>noir</i> Ø 75 mm | 1 |  | 8.95 | 9.64 |

YUMA















| EAN-Nr. <i>no EAN</i> | Artikel Nr. <i>no d'article</i> | Beschreibung <i>description</i> | VPE <i>ce</i> | VE <i>ue</i> | UVP pro Stk. <i>PVC</i> CHF excl. | UVP pro Stk. <i>PVC</i> CHF incl. |
|--------------------------|------------------------------------|------------------------------------|------------------|-----------------|---|---|
|--------------------------|------------------------------------|------------------------------------|------------------|-----------------|---|---|

Seifenspender Yuma

Distributeur de savon Yuma



Keramik
Céramique

| | | | | | | |
|--|-------------------|---|---|---|--------------|--------------|
|  | 48 2337 42 | weiss matt <i>blanc</i> Ø 8.3 x 15.1 cm | 4 |  | 17.89 | 19.27 |
|  | 48 2337 56 | blau matt <i>bleu</i> Ø 8.3 x 15.1 cm | 4 |  | 17.89 | 19.27 |
|  | 48 2337 57 | anthrazit matt <i>anthrazit</i> Ø 8.3 x 15.1 cm | 4 |  | 17.89 | 19.27 |
|  | 48 2337 70 | gelb matt <i>jeune</i> Ø 8.3 x 15.1 cm | 4 |  | 17.89 | 19.27 |
|  | 48 2337 80 | schwarz matt <i>noir</i> Ø 8.3 x 15.1 cm | 4 |  | 17.89 | 19.27 |
|  | 48 2337 93 | berry matt <i>berry</i> Ø 8.3 x 15.1 cm | 4 |  | 17.89 | 19.27 |
|  | 48 2337 94 | braun matt <i>brun</i> Ø 8.3 x 15.1 cm | 4 |  | 17.89 | 19.27 |

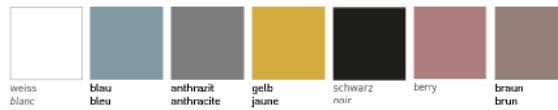

YUMA















| EAN-Nr. <i>no EAN</i> | Artikel Nr. <i>no d'article</i> | Beschreibung <i>description</i> | VPE <i>ce</i> | VE <i>ue</i> | UVP pro Stk. <i>PVC</i> CHF excl. | UVP pro Stk. <i>PVC</i> CHF incl. |
|--------------------------|------------------------------------|------------------------------------|------------------|-----------------|---|---|
|--------------------------|------------------------------------|------------------------------------|------------------|-----------------|---|---|

Mundspülbecher Yuma

Gobelet à dents Yuma



Keramik
Céramique

| | | | | | | |
|---|-------------------|--|---|---|--------------|--------------|
|  7 611038 249199 | 48 2338 42 | weiss matt <i>blanc</i> Ø 8.2 x 11.8 cm | 4 |  | 12.02 | 12.95 |
|  7 611038 249212 | 48 2338 56 | blau matt <i>bleu</i> Ø 8.2 x 11.8 cm | 4 |  | 12.02 | 12.95 |
|  7 611038 249205 | 48 2338 57 | anthrazit matt <i>anthracite</i> Ø 8.2 x 11.8 cm | 4 |  | 12.02 | 12.95 |
|  7 611038 249229 | 48 2338 70 | gelb matt <i>jeune</i> Ø 8.2 x 11.8 cm | 4 |  | 12.02 | 12.95 |
|  7 611038 249182 | 48 2338 80 | schwarz matt <i>noir</i> Ø 8.2 x 11.8 cm | 4 |  | 12.02 | 12.95 |
|  7 611038 249236 | 48 2338 93 | berry matt <i>berry</i> Ø 8.2 x 11.8 cm | 4 |  | 12.02 | 12.95 |
|  7 611038 249243 | 48 2338 94 | braun matt <i>brun</i> Ø 8.2 x 11.8 cm | 4 |  | 12.02 | 12.95 |

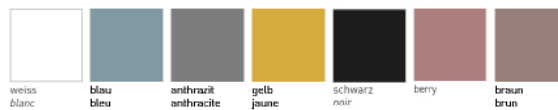





RUMA

| EAN-Nr. no EAN | Artikel Nr. no d'article | Beschreibung description | VPE ce | VE ue | UVP pro Stk. PVC CHF excl. | UVP pro Stk. PVC CHF incl. |
|-------------------|-----------------------------|-----------------------------|-----------|----------|----------------------------------|----------------------------------|
|-------------------|-----------------------------|-----------------------------|-----------|----------|----------------------------------|----------------------------------|

WC-Bürstengarnitur Ruma

Garniture de WC Ruma







| | | | | | | |
|--|-------------------|-----------------------------------|---|---|--------------|--------------|
|  7 611038 243340 | 48 2332 00 | weiss blanc Ø 9.4 x 36.5 cm | 4 |  | 27.03 | 29.11 |
|  7 611038 188023 | 48 2333 00 | nude Ø 9.4 x 36.5 cm | 4 |  | 27.03 | 29.11 |



Keramik
Céramique

WC-Ersatzbürstenkopf





Brosse de rechange

| | | | | | | |
|--|-------------------|----------------------------|-----|---|-------------|-------------|
|  7 611038 116569 | 45 9996 98 | weiss blanc Ø 70 mm | 100 |  | 8.39 | 9.03 |
|  7 611038 116576 | 45 9997 98 | schwarz noir Ø 70 mm | 100 |  | 8.39 | 9.03 |

Seifenspender Ruma

Distributeur de Savon Ruma



| | | | | | | |
|--|-------------------|--------------------------------|---|---|--------------|--------------|
|  7 611038 243234 | 48 2332 01 | weiss blanc Ø 11 x 15 cm | 4 |  | 20.04 | 21.58 |
|  7 611038 243395 | 48 2333 01 | nude Ø 11 x 15 cm | 4 |  | 20.04 | 21.58 |





Keramik
Céramique



Mundspülbecher Ruma

Gobelet à dents Ruma





| | | | | | | |
|--|-------------------|-----------------------------------|---|---|--------------|--------------|
|  7 611038 243364 | 48 2332 02 | weiss blanc Ø 7.1 x 10.6 cm | 4 |  | 12.02 | 12.95 |
|  7 611038 243241 | 48 2333 02 | nude Ø 7.1 x 10.6 cm | 4 |  | 12.02 | 12.95 |

Keramik
Céramique







GRENADA



| EAN-Nr. no EAN | Artikel Nr. no d'article | Beschreibung description | VPE ce | VE ue | UVP pro Stk. PVC CHF excl. | UVP pro Stk. PVC CHF incl. |
|-------------------|-----------------------------|-----------------------------|-----------|----------|----------------------------------|----------------------------------|
|-------------------|-----------------------------|-----------------------------|-----------|----------|----------------------------------|----------------------------------|

| WC-Bürstengarnitur Grenada | | Garniture de WC Grenada | | | | |
|---|-------------------|---|---|---|--------------|--------------|
|  | 48 2317 00 | weiss/blau blanc/bleu Ø 7.8 x 36.5 cm | 1 |  | 24.70 | 26.60 |





Keramik
Céramique

| WC-Ersatzbürstenkopf | | Brosse de rechange | | | | |
|---|-------------------|----------------------------|-----|---|-------------|-------------|
|  | 45 9996 98 | weiss blanc Ø 70 mm | 100 |  | 8.39 | 9.03 |
|  | 45 9997 98 | schwarz noir Ø 70 mm | 100 |  | 8.39 | 9.03 |

| Seifenspender Grenada | | Distributeur Savon Grenada | | | | |
|---|-------------------|---|---|---|--------------|--------------|
|  | 48 2317 01 | weiss/blau blanc/bleu Ø 6 x 20 cm | 1 |  | 17.52 | 18.87 |



Keramik
Céramique



| Mundspülbecher Grenada | | Gobelet à dents Grenada | | | | |
|---|-------------------|---|---|---|--------------|--------------|
|  | 48 2317 02 | weiss/blau blanc/bleu Ø 7 x 11.3 cm | 1 |  | 13.79 | 14.86 |





Keramik
Céramique

GRENADA

| | EAN-Nr. <i>no EAN</i> | Artikel Nr. <i>no d'article</i> | Beschreibung <i>description</i> | VPE <i>ce</i> | VE <i>ue</i> | UVP pro Stk. <i>PVC</i> CHF excl. | UVP pro Stk. <i>PVC</i> CHF incl. |
|--|--------------------------|------------------------------------|------------------------------------|------------------|-----------------|---|---|
|--|--------------------------|------------------------------------|------------------------------------|------------------|-----------------|---|---|

| Seifenschale Grenada | | Porte-savonette Grenada | | | | | |
|---|--|-------------------------|--|---|---|--------------|--------------|
|  |  7 611038 246235 | 48 2317 03 | weiss/blau <i>blanc/bleu</i> 12.5 x 2.5 x 9 cm | 1 |  | 12.39 | 13.35 |

Keramik
Céramique





| Kosmetikdose Grenada | | Boîte cosmétique Grenada | | | | | |
|---|--|--------------------------|--|---|---|--------------|--------------|
|  |  7 611038 246242 | 48 2317 04 | weiss/blau <i>blanc/bleu</i> Ø 8 x 13 cm | 1 |  | 16.22 | 17.46 |



Keramik
Céramique



CRUSHED

| | EAN-Nr. no EAN | Artikel Nr. no d'article | Beschreibung description | VPE ce | VE ue | UVP pro Stk. PVC CHF excl. | UVP pro Stk. PVC CHF incl. |
|--|-------------------|-----------------------------|-----------------------------|-----------|----------|----------------------------------|----------------------------------|
|--|-------------------|-----------------------------|-----------------------------|-----------|----------|----------------------------------|----------------------------------|

| WC-Bürstengarnitur Crushed | | Garniture de WC Crushed | | | | | |
|---|--|-------------------------|---------------------------------|---|---|--------------|--------------|
|  |  7 611038 246501 | 48 2324 00 | Glas verre Ø 10.8 x 35 cm | 1 |  | 63.37 | 68.25 |

| WC-Ersatzbürstenkopf | | Brosse de rechange | | | | | |
|----------------------|--|--------------------|----------------------------|-----|---|-------------|-------------|
| |  7 611038 116569 | 45 9996 98 | weiss blanc Ø 70 mm | 100 |  | 8.39 | 9.03 |
| |  7 611038 116576 | 45 9997 98 | schwarz noir Ø 70 mm | 100 |  | 8.39 | 9.03 |

| Seifenspender Crushed | | Distributeur de savon Crushed | | | | | |
|---|--|-------------------------------|----------------------------------|---|---|--------------|--------------|
|  |  7 611038 246518 | 48 2324 01 | Glas verre Ø 7.8 x 18.5 cm | 1 |  | 37.28 | 40.15 |

| Mundspülbecher Crushed | | Gobelet à dents Crushed | | | | | |
|---|--|-------------------------|-----------------------------------|---|---|--------------|--------------|
|  |  7 611038 246525 | 48 2324 02 | Glas verre Ø 8.35 x 10.3 cm | 1 |  | 18.64 | 20.07 |

INA

| EAN-Nr. <i>no EAN</i> | Artikel Nr. <i>no d'article</i> | Beschreibung <i>description</i> | VPE <i>ce</i> | VE <i>ue</i> | UVP pro Stk. <i>PVC</i> CHF excl. | UVP pro Stk. <i>PVC</i> CHF incl. |
|--------------------------|------------------------------------|------------------------------------|------------------|-----------------|---|---|
|--------------------------|------------------------------------|------------------------------------|------------------|-----------------|---|---|

WC-Bürstengarnitur Ina

Garniture de WC Ina







Glas
Verre

| | | | | | | |
|--|-------------------|---------------------------|---|---|--------------|--------------|
|  7 611038 188030 | 48 2328 00 | emerald Ø 10.3 x 36 cm | 4 |  | 43.80 | 47.17 |
|--|-------------------|---------------------------|---|---|--------------|--------------|

WC-Ersatzbürstenkopf

Brosse de rechange



| | | | | | | |
|--|-------------------|-----------------------------------|-----|---|-------------|-------------|
|  7 611038 116583 | 45 9998 98 | weiss <i>blanc</i> Ø 80 mm | 100 |  | 8.39 | 9.03 |
|  7 611038 116590 | 45 9999 98 | schwarz <i>noir</i> Ø 80 mm | 100 |  | 8.39 | 9.03 |

Schaumseifenspender Ina

Distributeur savon mousse Ina





- Extrem sparsam durch Beimischen von Wasser und Luft.
- Beim Herauspumpen der Seife wird diese mit Luft und Wasser gemischt, wodurch ein fülliger Schaum entsteht
- *Très économique grâce à l'ajout d'eau et d'air*
- *Lors du pompage du savon, ce dernier est mélangé à de l'eau et de l'air, occasionnant ainsi la création d'une mousse onctueuse*

| | | | | | | |
|--|-------------------|----------------------------|---|---|--------------|--------------|
|  7 611038 236601 | 48 2328 01 | emerald Ø 9.8 x 14.5 cm | 4 |  | 30.29 | 32.62 |
|--|-------------------|----------------------------|---|---|--------------|--------------|

Ersatzpumpe Ina

Pompe de rechange

| | | | | | | |
|--|-------------------|----------------------------|---|---|--------------|--------------|
|  7 611038 679347 | 48 2328 96 | verchromt <i>chromé</i> | 1 |  | 11.93 | 12.85 |
|--|-------------------|----------------------------|---|---|--------------|--------------|

INA

| EAN-Nr. <i>no EAN</i> | Artikel Nr. <i>no d'article</i> | Beschreibung <i>description</i> | VPE <i>ce</i> | VE <i>ue</i> | UVP pro Stk. <i>PVC</i> CHF excl. | UVP pro Stk. <i>PVC</i> CHF incl. |
|--------------------------|------------------------------------|------------------------------------|------------------|-----------------|---|---|
|--------------------------|------------------------------------|------------------------------------|------------------|-----------------|---|---|

Mundspülbecher Ina

Gobelet à dents Ina



48 2328 02

emerald
Ø 8 x 11.8 cm

4



23.76

25.59

Glas
Verre

PINTA

| | EAN-Nr. <i>no EAN</i> | Artikel Nr. <i>no d'article</i> | Beschreibung <i>description</i> | VPE <i>ce</i> | VE <i>ue</i> | UVP pro Stk. <i>PVC</i> CHF excl. | UVP pro Stk. <i>PVC</i> CHF incl. |
|--|--------------------------|------------------------------------|------------------------------------|------------------|-----------------|---|---|
|--|--------------------------|------------------------------------|------------------------------------|------------------|-----------------|---|---|

WC-Bürstengarnitur Pinta

Garniture de WC Pinta



7 611038 163617

45 1809 01

weiss frosted
blanc frosted
Ø 9 x 40 cm

1



45.20

48.68

Glas
Verre

WC-Ersatzbürstenkopf

Brosse de rechange



7 611038 116569

45 9996 98

weiss
blanc
Ø 70 mm

100



8.39

9.03

Seifenspender Pinta

Distributeur de savon Pinta



7 611038 163587

45 1809 02

weiss frosted
blanc frosted
Ø 6.8 x 20.8 cm

1



32.15

34.63

Glas
Verre

Seifenschale Pinta

Porte-savonnette Pinta



7 611038 163600

45 1809 04

weiss frosted
blanc frosted
13.8 x 8.9 x 3 cm

1





19.11

20.58



Glas
Verre

PINTA

| | EAN-Nr. <i>no EAN</i> | Artikel Nr. <i>no d'article</i> | Beschreibung <i>description</i> | VPE <i>ce</i> | VE <i>ue</i> | UVP pro Stk. <i>PVC</i> CHF excl. | UVP pro Stk. <i>PVC</i> CHF incl. |
|--|--------------------------|------------------------------------|------------------------------------|------------------|-----------------|---|---|
|--|--------------------------|------------------------------------|------------------------------------|------------------|-----------------|---|---|

| Mundspülbecher Pinta | | Gobelet à dents Pinta | | | | | |
|---|--|------------------------------|--|---|---|--------------|--------------|
|  |  7 611038 163594 | 45 1809 03 | weiss frosted <i>blanc frosted</i> Ø 6.4 x 11 cm | 1 |  | 19.57 | 21.08 |

Glas
Verre

| Kosmetikdose Pinta | | Boîte cosmétique Pinta | | | | | |
|---|--|-------------------------------|--|---|---|--------------|--------------|
|  |  7 611038 163624 | 45 1809 05 | weiss frosted <i>blanc frosted</i> Ø 9.3 x 11.3 cm | 1 |  | 25.63 | 27.60 |

Glas
Verre

FARIN

| | EAN-Nr. no EAN | Artikel Nr. no d'article | Beschreibung description | VPE ce | VE ue | UVP pro Stk. PVC CHF excl. | UVP pro Stk. PVC CHF incl. |
|--|-------------------|-----------------------------|-----------------------------|-----------|----------|----------------------------------|----------------------------------|
|--|-------------------|-----------------------------|-----------------------------|-----------|----------|----------------------------------|----------------------------------|

WC-Bürstengarnitur Farin

Garniture de WC Farin



Glas
Verre

| | | | | | | |
|--|-------------------|-------------------------------|---|--|--------------|--------------|
| | 48 2339 30 | lila Ø 11.7 x 38.5 cm | 1 | | 27.03 | 29.11 |
| | 48 2339 50 | orange Ø 11.7 x 38.5 cm | 1 | | 27.03 | 29.11 |
| | 48 2339 54 | aqua Ø 11.7 x 38.5 cm | 1 | | 27.03 | 29.11 |
| | 48 2339 57 | anthrazit Ø 11.7 x 38.5 cm | 1 | | 27.03 | 29.11 |

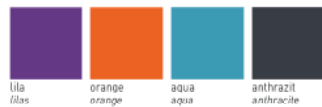

lila
lilas
orange
orange
aqua
aqua
anthrazit
anthracite

WC-Ersatzbürstenkopf

Brosse de rechange

| | | | | | | |
|--|-------------------|----------------------------|-----|--|-------------|-------------|
| | 45 9996 98 | weiss blanc Ø 70 mm | 100 | | 8.39 | 9.03 |
| | 45 9997 98 | schwarz noir Ø 70 mm | 100 | | 8.39 | 9.03 |

Seifenspender Farin

Distributeur de savon Farin



Glas
Verre

| | | | | | | |
|--|-------------------|----------------------------|---|--|--------------|--------------|
| | 48 2340 30 | lila Ø 8.4 x 17 cm | 4 | | 17.89 | 19.27 |
| | 48 2340 50 | orange Ø 8.4 x 17 cm | 4 | | 17.89 | 19.27 |
| | 48 2340 54 | aqua Ø 8.4 x 17 cm | 4 | | 17.89 | 19.27 |
| | 48 2340 57 | anthrazit Ø 8.4 x 17 cm | 4 | | 17.89 | 19.27 |

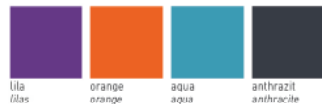

lila
lilas
orange
orange
aqua
aqua
anthrazit
anthracite

FARIN

| | EAN-Nr. no EAN | Artikel Nr. no d'article | Beschreibung description | VPE ce | VE ue | UVP pro Stk. PVC CHF excl. | UVP pro Stk. PVC CHF incl. |
|--|-------------------|-----------------------------|-----------------------------|-----------|----------|----------------------------------|----------------------------------|
|--|-------------------|-----------------------------|-----------------------------|-----------|----------|----------------------------------|----------------------------------|

Mundspülbecher Farin

Gobelet à dents Farin



Glas
Verre

| | | | | | | |
|--|-------------------|------------------------------|---|--|--------------|--------------|
| | 48 2341 30 | lila Ø 8.4 x 10.7 cm | 4 | | 15.56 | 16.76 |
| | 48 2341 50 | orange Ø 8.4 x 10.7 cm | 4 | | 15.56 | 16.76 |
| | 48 2341 54 | aqua Ø 8.4 x 10.7 cm | 4 | | 15.56 | 16.76 |
| | 48 2341 57 | anthrazit Ø 8.4 x 10.7 cm | 4 | | 15.56 | 16.76 |

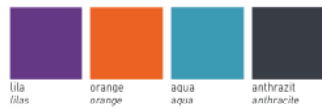

lila
lilas
orange
orange
aqua
aqua
anthrazit
anthracite

Kosmetikdose Farin

Boîte cosmétique Farin



Glas
Verre

| | | | | | | |
|--|-------------------|---------------------------|---|--|--------------|--------------|
| | 48 2342 30 | lila Ø 8.8 x 6 cm | 4 | | 17.89 | 19.27 |
| | 48 2342 50 | orange Ø 8.8 x 6 cm | 4 | | 17.89 | 19.27 |
| | 48 2342 54 | aqua Ø 8.8 x 6 cm | 4 | | 17.89 | 19.27 |
| | 48 2342 57 | anthrazit Ø 8.8 x 6 cm | 4 | | 17.89 | 19.27 |

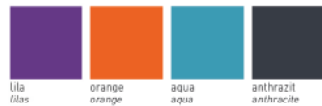

lila
lilas
orange
orange
aqua
aqua
anthrazit
anthracite



IRIS

| | EAN-Nr. <i>no EAN</i> | Artikel Nr. <i>no d'article</i> | Beschreibung <i>description</i> | VPE <i>ce</i> | VE <i>ue</i> | UVP pro Stk. <i>PVC</i> CHF excl. | UVP pro Stk. <i>PVC</i> CHF incl. |
|--|--------------------------|------------------------------------|------------------------------------|------------------|-----------------|---|---|
|--|--------------------------|------------------------------------|------------------------------------|------------------|-----------------|---|---|

Seifenspender Iris

Distributeur de savon Iris





| | | | | | | |
|--|-------------------|---|---|---|--------------|--------------|
|  7 611038 236564 | 48 2329 01 | irisierend <i>irisé</i> Ø 7.8 x 19 cm | 4 |  | 20.04 | 21.58 |
|--|-------------------|---|---|---|--------------|--------------|

Glas
Verre

Mundspülbecher Iris

Gobelet à dents Iris



| | | | | | | |
|--|-------------------|---|---|---|--------------|--------------|
|  7 611038 236571 | 48 2329 02 | irisierend <i>irisé</i> Ø 7.8 x 10.7 cm | 4 |  | 15.56 | 16.76 |
|--|-------------------|---|---|---|--------------|--------------|

Glas
Verre

KIRA

| EAN-Nr. <i>no EAN</i> | Artikel Nr. <i>no d'article</i> | Beschreibung <i>description</i> | VPE <i>ce</i> | VE <i>ue</i> | UVP pro Stk. <i>PVC</i> CHF excl. | UVP pro Stk. <i>PVC</i> CHF incl. |
|--------------------------|------------------------------------|------------------------------------|------------------|-----------------|---|---|
|--------------------------|------------------------------------|------------------------------------|------------------|-----------------|---|---|

Seifenspender Kira

Distributeur de Savon Kira



48 2330 01

hellblau
bleu clair
Ø 7.1 x 16.5 cm

4



20.04

21.58

Glas
Verre

Mundspülbecher Kira

Gobelet à dents Kira



48 2330 02

hellblau
bleu clair
Ø 7 x 9 cm

4



15.56

16.76

Glas
Verre

FACETTE

| | EAN-Nr. no EAN | Artikel Nr. no d'article | Beschreibung description | VPE ce | VE ue | UVP pro Stk. PVC CHF excl. | UVP pro Stk. PVC CHF incl. |
|--|-------------------|-----------------------------|-----------------------------|-----------|----------|----------------------------------|----------------------------------|
|--|-------------------|-----------------------------|-----------------------------|-----------|----------|----------------------------------|----------------------------------|

NEW

Seifenspender Facette

Distributeur de savon Facette



48 2352 01

mint
8.5 x 8.5 x 16 cm

1



12.07

13.—



48 2353 01

transparent
8.5 x 8.5 x 16 cm

1



12.07

13.—



100% reeeyceltes Glas
100% verre reccyclé

NEW

Mundspülbecher Facette

Gobelet à dents Facette



48 2352 02

mint
6.6 x 6.6 x 10.9 cm

1



9.27

9.99



48 2353 02

transparent
6.6 x 6.6 x 10.9 cm

1



9.27

9.99



100% reeeyceltes Glas
100% verre reccyclé

Seifenschale Facette

Porte-savonette Facette



48 2352 03

mint
12.3 x 12.3 x 2.5 cm

1

9.27

9.99



48 2353 03

transparent
12.3 x 12.3 x 2.5 cm

1

9.27

9.99



100% reeeyceltes Glas
100% verre reccyclé

GOLI



| EAN-Nr. no EAN | Artikel Nr. no d'article | Beschreibung description | VPE ce | VE ue | UVP pro Stk. PVC CHF excl. | UVP pro Stk. PVC CHF incl. |
|-------------------|-----------------------------|-----------------------------|-----------|----------|----------------------------------|----------------------------------|
|-------------------|-----------------------------|-----------------------------|-----------|----------|----------------------------------|----------------------------------|

WC-Bürstengarnitur Goli

Garniture de WC Goli





Edelstahl
Inox

| | | | | | | |
|--|-------------------|-----------------------|---|---|--------------|--------------|
|  7 611038 164607 | 48 2310 81 | platin Ø 9 x 40 cm | 1 |  | 60.58 | 65.24 |
|--|-------------------|-----------------------|---|---|--------------|--------------|

WC-Ersatzbürstenkopf

Brosse de rechange



| | | | | | | |
|--|-------------------|----------------------------|---|---|-------------|-------------|
|  7 611038 181000 | 45 9995 98 | schwarz noir Ø 80 mm | 1 |  | 8.95 | 9.64 |
|--|-------------------|----------------------------|---|---|-------------|-------------|

Seifenspender Goli

Distributeur savon Goli



Edelstahl
Inox



| | | | | | | |
|--|-------------------|-------------------------|---|---|--------------|--------------|
|  7 611038 164584 | 48 2311 81 | platin Ø 5.7 x 19 cm | 1 |  | 32.62 | 35.13 |
|--|-------------------|-------------------------|---|---|--------------|--------------|

Seifenschale Goli

Porte-savonnette Goli



Edelstahl
Inox



| | | | | | | |
|--|-------------------|-----------------------|---|---|--------------|--------------|
|  7 611038 164591 | 48 2313 81 | platin Ø 11 x 2 cm | 1 |  | 16.68 | 17.97 |
|--|-------------------|-----------------------|---|---|--------------|--------------|

Mundspülbecher Goli

Gobelet à dents Goli



Edelstahl
Inox

| | | | | | | |
|--|-------------------|-------------------------|---|---|--------------|--------------|
|  7 611038 164577 | 48 2312 81 | platin Ø 6.5 x 10 cm | 1 |  | 19.57 | 21.08 |
|--|-------------------|-------------------------|---|---|--------------|--------------|

GOLI

| EAN-Nr. <i>no EAN</i> | Artikel Nr. <i>no d'article</i> | Beschreibung <i>description</i> | VPE <i>ce</i> | VE <i>ue</i> | UVP pro Stk. <i>PVC</i> CHF excl. | UVP pro Stk. <i>PVC</i> CHF incl. |
|--------------------------|------------------------------------|------------------------------------|------------------|-----------------|---|---|
|--------------------------|------------------------------------|------------------------------------|------------------|-----------------|---|---|

Kosmetikdose Goli

Boîte cosmétique Goli



48 2314 81

platin
Ø 8.5 x 8.5 cm

1



24.23

26.10

Edelstahl
Inox

WC-Sitz Madrid Slow Down

Siège de WC Madrid Slow Down



31 1704 73

silver - MDF - FSC® 100%
42-46.5 x 37.1 cm ; 16

4



94.13

101.38



31 1704 83

copper - MDF - FSC® 100%
42-46.5 x 37.1 cm ; 16

4



94.13

101.38

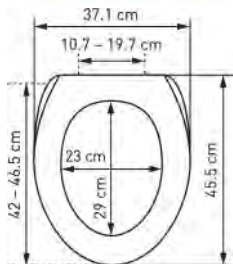

mit Metall-Scharnieren
avec charnières en métal



Das Zeichen für verantwortungsvolle Waldwirtschaft
La marca de la gestión forestal responsable

OAK

| | EAN-Nr. no EAN | Artikel Nr. no d'article | Beschreibung description | VPE ce | VE ue | UVP pro Stk. PVC CHF excl. | UVP pro Stk. PVC CHF incl. |
|--|-------------------|-----------------------------|-----------------------------|-----------|----------|----------------------------------|----------------------------------|
|--|-------------------|-----------------------------|-----------------------------|-----------|----------|----------------------------------|----------------------------------|

NEW

WC-Bürstengarnitur Oak

Garniture de WC Oak



Eichenholz
Bois en chêne



48 2349 00

Eiche - FSC® 100%
chêne - FSC® 100%
Ø 11 x 41 cm

1



36.81

39.65



Das Zeichen für
verantwortungsvolle Waldwirtschaft
Le matériel de la gestion
forestière responsable

NEW

Seifenspender Oak

Distributeur de savon Oak



Eichenholz
Bois en chêne



48 2349 01

Eiche - FSC® 100%
chêne - FSC® 100%
Ø 8 x 16.5 cm

1



27.91

30.06



Das Zeichen für
verantwortungsvolle Waldwirtschaft
Le matériel de la gestion
forestière responsable

NEW

Mundspülbecher Oak

Gobelet à dents Oak



Eichenholz
Bois en chêne



48 2349 02

Eiche - FSC® 100%
chêne - FSC® 100%
Ø 8 x 11.5 cm

1



23.25

25.04



Das Zeichen für
verantwortungsvolle Waldwirtschaft
Le matériel de la gestion
forestière responsable

NEW

Seifenschale Oak

Porte-savonette Oak



Eichenholz
Bois en chêne



48 2349 03

Eiche - FSC® 100%
chêne - FSC® 100%
13 x 9 x 2.5 cm

1



18.59

20.02



Das Zeichen für
verantwortungsvolle Waldwirtschaft
Le matériel de la gestion
forestière responsable

2.72





Wandserien und Garnituren *Series murales et garnitures*

Kapitel 3 - Inhaltsverzeichnis

Chapitre 3 - Sommaire

| | |
|---|------|
| CHIC 96 | 3.6 |
| Biasca | 3.11 |
| Quinto | 3.18 |
| Sofia | 3.23 |
| Roma | 3.29 |
| Napoli | 3.33 |
| Accessoires <i>Accessoires</i> | 3.35 |
| Laguna | 3.39 |
| SMART | 3.41 |
| Wandseifenspender <i>Distributeur de savon mural</i> | 3.43 |





Wandserien und Garnituren Series murales et garnitures

Befestigung und Befestigungsmaterial

Fixation et matériel de fixation



Wandserien erhältlich zum Schrauben oder Kleben. Piktogramme auf den Verpackungen beachten.

Séries murales disponibles à visser ou à coller. Observer les pictogrammes sur les emballages.

i.Stick Klebeset

i.Stick jeux de fixation



Mit dem i.Stick Klebeset (45130298) können die klebbaren Accessoires einfach befestigt werden.

Le kit de colle i.Stick (45130298) permet de fixer facilement les accessoires collables.

Inklusive Befestigungsmaterial

Matériel de fixation inclus

Befestigungsmaterial zum Schrauben in jeder Verpackung inkludiert. Klebstoff muss separat gekauft werden.

Matériel de fixation à visser inclus dans chaque emballage. La colle doit être achetée séparément.



Biasca

Garantiert einen sicheren Halt durch glasfaserverstärkte Befestigungsplatte. Halterungen zum Reinigen des Produktes und der Wand einfach abnehmbar. Passt auf bestehende Bohrlöcher von 20 - 40 mm.

Garantit un maintien sûr grâce à la plaque de fixation renforcée de fibres de verre. Supports facilement amovibles pour le nettoyage du produit et du mur. S'adapte aux trous de forage horizontaux existants de 20 à 40 mm.



bodenschatz

Chic 96



Passt seit Jahrzehnten auf bestehende Bohrlöcher 30 - 40 mm. Kann auch mit Kleber montiert werden. Zum Reinigen einfach abnehmbar.

S'adapte depuis des décennies aux trous de forage existants de 30 à 40 mm. Peut également être monté avec de la colle. Facilement démontable pour le nettoyage.





CHIC 96

| EAN-Nr. no EAN | Artikel Nr. no d'article | Beschreibung description | VPE ce | VE ue | UVP pro Stk. PVC CHF excl. | UVP pro Stk. PVC CHF incl. |
|-------------------|-----------------------------|-----------------------------|-----------|----------|----------------------------------|----------------------------------|
|-------------------|-----------------------------|-----------------------------|-----------|----------|----------------------------------|----------------------------------|

| WC-Papierhalter Deckel Chic 96 | | Porte-papier WC Chic 96 | | | | | |
|---|--|-------------------------|---|---|---|--------------|--------------|
|  |  7 611038 140076 | 45 2796 04 | verchromt <i>chromé</i> 13.5 x 13 x 14 cm | 1 |  | 73.62 | 79.29 |

bodenschutz





| Glashalter einfach Chic 96 | | Porte-verre simple Chic 96 | | | | | |
|---|--|----------------------------|--|---|---|--------------|--------------|
|  |  7 611038 140045 | 45 2796 01 | Messing verchromt <i>Laiton chromé</i> 11.5 x 8 x 9 cm | 1 |  | 67.10 | 72.27 |

bodenschutz



| Ersatzring zu Glashalter | | Anneau de rechange | | | | | |
|--------------------------|--|--------------------|---|---|---|-------------|-------------|
| |  7 611038 162320 | 45 2796 90 | Kunststoff <i>plastique</i> Ø 70 mm | 1 |  | 6.76 | 7.28 |

| Doppelglashalter Chic 96 | | Porte-verre double Chic 96 | | | | | |
|---|--|----------------------------|---|---|---|---------------|---------------|
|  |  7 611038 140052 | 45 2796 02 | Messing verchromt <i>Laiton chromé</i> 11 x 18 x 9 cm | 1 |  | 102.51 | 110.41 |



bodenschutz



| Ersatzring zu Doppelglashalter | | Anneau de rechange | | | | | |
|--------------------------------|--|--------------------|---|---|---|-------------|-------------|
| |  7 611038 162337 | 45 2796 92 | Kunststoff <i>plastique</i> Ø 67 mm | 1 |  | 6.76 | 7.28 |

CHIC 96



| EAN-Nr. no EAN | Artikel Nr. no d'article | Beschreibung description | VPE ce | VE ue | UVP pro Stk. PVC CHF excl. | UVP pro Stk. PVC CHF incl. |
|-------------------|-----------------------------|-----------------------------|-----------|----------|----------------------------------|----------------------------------|
|-------------------|-----------------------------|-----------------------------|-----------|----------|----------------------------------|----------------------------------|

| Zahnglas CHIC 96 | Verre à dents CHIC 96 | | | | | | |
|---|--|------------|---|---|---|------|-------|
|  |  7 611038 350970 | 35 0510 10 | glasklar verre clair Ø 75 / 65 mm ; 85 mm | 6 |  | 9.79 | 10.54 |

bodenschatz



Passt zur Serie CHIC 96
Va pour la série CHIC 96



| Glasseifenhalter Chic 96 | Porte-savonnette verre Chic 96 | | | | | | |
|---|---|------------|--|---|--|-------|-------|
|  |  7 611038 140069 | 45 2796 03 | Messing verchromt Laiton chromé 11.5 x 13.5 x 4.5 cm | 1 |  | 67.10 | 72.27 |

bodenschatz



| Seifenschale CHIC 96 | Porte-savonnette CHIC 96 | | | | | | |
|---|--|------------|--|---|---|-------|-------|
|  |  7 611038 350987 | 35 0610 10 | glasklar verre clair Ø 70 mm ; 135 x 40 mm | 6 |  | 15.56 | 16.76 |

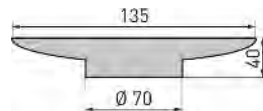

bodenschatz



| Ersatzring zu Seifenhalter | Anneau de rechange | | | | | | |
|----------------------------|--|------------|--|---|---|------|------|
| |  7 611038 162344 | 45 2796 94 | Kunststoff / mit Ecken plastique Ø 69.5 mm | 1 |  | 6.76 | 7.28 |



CHIC 96

| EAN-Nr. no EAN | Artikel Nr. no d'article | Beschreibung description | VPE ce | VE ue | UVP pro Stk. PVC CHF excl. | UVP pro Stk. PVC CHF incl. |
|-------------------|-----------------------------|-----------------------------|-----------|----------|----------------------------------|----------------------------------|
|-------------------|-----------------------------|-----------------------------|-----------|----------|----------------------------------|----------------------------------|



| Glasseifenspender Chic 96 | | Distributeur savon Chic 96 | | | | | |
|---|--|----------------------------|---|---|---|--------|--------|
|  |  7 611038 143282 | 45 2796 07 | Messing verchromt <i>Laiton chromé</i> 8 x 11.5 x 18 cm | 1 |  | 118.36 | 127.47 |

bodenschatz







| Glasseifenspender CHIC 96/07 | | Distributeur/savon/verre CHI | | | | | |
|--|--|------------------------------|--|---|---|-------|-------|
|  |  7 611038 140137 | 45 2796 05 | glasklar <i>verre claire</i> 6.9 x 9 x 17.5 cm | 1 |  | 54.05 | 58.22 |

bodenschatz

| Ersatzpumpe ohne Gehäuse CHIC | | Pompe de rechange CHIC | | | | | |
|---|--|------------------------|--------------------------------|---|---|-------|-------|
|  |  7 612363 154707 | 45 2796 95 | Kunststoff <i>plastique</i> | 1 |  | 14.45 | 15.56 |

bodenschatz

| Ersatzring Glasseifenspender | | Anneau de rechange | | | | | |
|------------------------------|--|--------------------|---|---|---|------|------|
| |  7 611038 167851 | 45 2796 91 | Kunststoff mit Ecken <i>plastique</i> Ø 62 mm | 1 |  | 6.76 | 7.28 |



| Badetuchstange Chic 96 | | Porte-Linge mural Chic 96 | | | | | |
|---|--|---------------------------|--|---|---|-------|-------|
|  |  7 611038 143268 | 45 2796 08 | Messing verchromt <i>Laiton chromé</i> 66.5 x 9 x 4 cm ; 60 cm | 1 |  | 77.35 | 83.31 |
| |  7 611038 143275 | 45 2796 09 | Messing verchromt <i>Laiton chromé</i> 86.5 x 9 x 4 cm ; 80 cm | 1 |  | 92.26 | 99.37 |

bodenschatz





CHIC 96

| EAN-Nr. no EAN | Artikel Nr. no d'article | Beschreibung description | VPE ce | VE ue | UVP pro Stk. PVC CHF excl. | UVP pro Stk. PVC CHF incl. |
|-------------------|-----------------------------|-----------------------------|-----------|----------|----------------------------------|----------------------------------|
|-------------------|-----------------------------|-----------------------------|-----------|----------|----------------------------------|----------------------------------|

| Handtuchhalter 2-armig Chic 96 | | Porte-Serviettes 2bras Chic 96 | | | | | |
|---|--|--------------------------------|--|---|---|--------|--------|
|  |  7 611038 143305 | 45 2796 11 | Messing verchromt <i>Laiton chromé</i> 41.5 x 7.5 x 7.5 cm ; 40 cm | 1 |  | 118.36 | 127.47 |

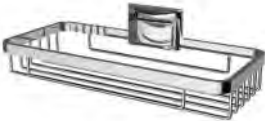

bodenschutz



| Drahtseifenhalter Chic 96 | | Porte-savonnette barre.Chic 96 | | | | | |
|---|--|--------------------------------|---|---|---|--------|--------|
|  |  7 611038 143295 | 45 2796 26 | Messing verchromt <i>Laiton chromé</i> 12 x 25 x 7 cm | 1 |  | 126.75 | 136.51 |



bodenschutz



| Wannenseifenschale CHIC 96 | | Porte-savonnette CHIC 96 | | | | | |
|--|---|--------------------------|--|---|--|-------|-------|
|  |  7 611038 140106 | 45 2796 70 | Draht verchromt <i>fil chromé</i> 18 x 10 x 4 cm | 1 |  | 67.10 | 72.27 |

bodenschutz



| Zahnglas 07/14 CHIC | | Verre à dents CHIC 07/14 | | | | | |
|---|--|--------------------------|---|---|---|-------|-------|
|  |  7 611038 140113 | 45 2796 75 | glasklar <i>verre claire</i> Ø 75 / 60 mm ; 95 mm | 6 |  | 10.90 | 11.74 |



bodenschutz

Passt zur Serie CHIC 07/14
Va pour la série CHIC 07/14



CHIC 96

| EAN-Nr. <i>no EAN</i> | Artikel Nr. <i>no d'article</i> | Beschreibung <i>description</i> | VPE <i>ce</i> | VE <i>ue</i> | UVP pro Stk. <i>PVC</i> CHF excl. | UVP pro Stk. <i>PVC</i> CHF incl. |
|--------------------------|------------------------------------|------------------------------------|------------------|-----------------|---|---|
|--------------------------|------------------------------------|------------------------------------|------------------|-----------------|---|---|

| Seifenschale 07/14 CHIC | | Porte-savonnette CHIC 07/14 | | | | | |
|---|--|-----------------------------|---|---|---|-------|-------|
|  |  7 611038 140120 | 45 2796 80 | glasklar <i>verre clair</i> 8.4 x 14 cm ; 60 mm | 6 |  | 17.15 | 18.47 |

bodenschatz

Passt zur Serie CHIC 07/14
Va pour la série CHIC 07/14

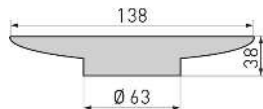

| Befestigungsset zu CHIC 96 | | Jeu de fixation pour CHIC96 | | | | | |
|---|--|-----------------------------|--|---|---|-------|-------|
|  |  7 611038 140281 | 45 2796 85 | mit Schrauben, Dübeln & Platte <i>avec vises & chevilles</i> | 1 |  | 11.46 | 12.35 |

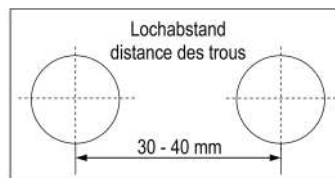

BIASCA





| | EAN-Nr. <i>no EAN</i> | Artikel Nr. <i>no d'article</i> | Beschreibung <i>description</i> | VPE <i>ce</i> | VE <i>ue</i> | UVP pro Stk. <i>PVC</i> CHF excl. | UVP pro Stk. <i>PVC</i> CHF incl. |
|--|--------------------------|------------------------------------|------------------------------------|------------------|-----------------|---|---|
|--|--------------------------|------------------------------------|------------------------------------|------------------|-----------------|---|---|

NEW

WC-Bürstengarnitur Biasca

Garniture de WC Biasca



| | | | | | | |
|--|-------------------|--|---|---|--------------|--------------|
|  7 611038 173265 | 45 2709 01 | verchromt <i>chromé</i> 11 x 13.9 x 35.8 cm | 1 |  | 63.37 | 68.25 |
|  7 611038 190354 | 45 2709 31 | schwarz matt <i>noir mat</i> 11 x 13.9 x 35.8 cm | 1 |  | 65.24 | 70.26 |

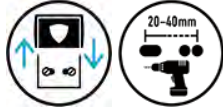



Passt auf bestehende horizontale Bohrlöcher im Abstand von 20 – 40 mm.

S'adapte aux trous déjà existants avec une distance de perçage de 20 – 40 mm

WC-Ersatzbürste mit Stiel

Brosse de rechange avec manche



| | | | | | | |
|---|-------------------|---------------------------------------|---|---|--------------|--------------|
|  7 611038 089542 | 45 5941 55 | verchromt <i>chromé</i> Ø 75 mm | 1 |  | 18.64 | 20.07 |
|---|-------------------|---------------------------------------|---|---|--------------|--------------|

Ersatzglas WC-Garnitur Biasca

Pot de rechange Biasca



| | | | | | | |
|--|-------------------|--------------------------|---|---|--------------|--------------|
|  7 611038 109189 | 45 2703 96 | frosted Ø 9.5 x 13 cm | 1 |  | 18.27 | 19.67 |
|--|-------------------|--------------------------|---|---|--------------|--------------|

BIASCA





| EAN-Nr. <i>no EAN</i> | Artikel Nr. <i>no d'article</i> | Beschreibung <i>description</i> | VPE <i>ce</i> | VE <i>ue</i> | UVP pro Stk. <i>PVC</i> CHF excl. | UVP pro Stk. <i>PVC</i> CHF incl. |
|--------------------------|------------------------------------|------------------------------------|------------------|-----------------|---|---|
|--------------------------|------------------------------------|------------------------------------|------------------|-----------------|---|---|

NEW

WC-Papierhalter Biasca

Porte-papier WC Biasca



| | | | | | | |
|--|-------------------|---|---|---|--------------|--------------|
|  7 611038 173685 | 45 2709 02 | verchromt <i>chromé</i> 5.4 x 17 x 13.4 cm | 1 |  | 43.34 | 46.67 |
|  7 611038 190361 | 45 2709 32 | schwarz matt <i>noir mat</i> 5.4 x 17 x 13.4 cm | 1 |  | 45.67 | 49.18 |

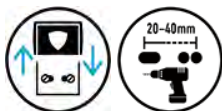

Passt auf bestehende horizontale Bohrlöcher im Abstand von 20 – 40 mm.





S'adapte aux trous déjà existants avec une distance de perçage de 20 – 40 mm.

NEW

Reserverollenhalter Biasca

Support réserve papier Biasca



| | | | | | | |
|---|-------------------|--|---|--|--------------|--------------|
|  7 611038 173692 | 45 2709 03 | verchromt <i>chromé</i> 7 x 9.6 x 17.7 cm | 1 |  | 36.35 | 39.14 |
|  7 611038 190378 | 45 2709 33 | schwarz matt <i>noir mat</i> 7 x 9.6 x 17.7 cm | 1 |  | 38.21 | 41.15 |



Passt auf bestehende horizontale Bohrlöcher im Abstand von 20 – 40 mm.





S'adapte aux trous déjà existants avec une distance de perçage de 20 – 40 mm.

NEW

Glashalter einfach Biasca

Porte-verre simple Biasca



| | | | | | | |
|--|-------------------|--|---|---|--------------|--------------|
|  7 611038 173814 | 45 2709 04 | verchromt <i>chromé</i> 9.6 x 6.9 x 10.5 cm | 1 |  | 29.82 | 32.12 |
|  7 611038 190385 | 45 2709 34 | schwarz matt <i>noir mat</i> 9.6 x 6.9 x 10.5 cm | 1 |  | 31.69 | 34.13 |



Passt auf bestehende horizontale Bohrlöcher im Abstand von 20 – 40 mm.

S'adapte aux trous déjà existants avec une distance de perçage de 20 – 40 mm.

BIASCA

| EAN-Nr. no EAN | Artikel Nr. no d'article | Beschreibung description | VPE ce | VE ue | UVP pro Stk. PVC CHF excl. | UVP pro Stk. PVC CHF incl. |
|-------------------|-----------------------------|-----------------------------|-----------|----------|----------------------------------|----------------------------------|
|-------------------|-----------------------------|-----------------------------|-----------|----------|----------------------------------|----------------------------------|

NEW

Doppelglashalter Biasca

Porte-verre double Biasca



45 2709 05

verchromt
chromé
9.6 x 18.9 x 10.3 cm

1



43.34

46.67



45 2709 35

schwarz matt
noir mat
9.6 x 18.9 x 10.3 cm

1



45.67

49.18

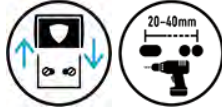

Passt auf bestehende horizontale Bohrlöcher im Abstand von 20 – 40 mm.

S'adapte aux trous déjà existants avec une distance de perçage de 20 – 40 mm

Zahnglas Biasca

Verre à dents Biasca



45 6000 32

frosted
Ø 55 / 67 mm ; 96 mm

1



10.81

11.64

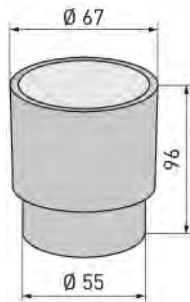

Passt zur Serie:
Biasca
*Va pour la série:
Biasca*

NEW

Glasseifenhalter Biasca

Porte-savonnette verre Biasca



45 2709 06

verchromt
chromé
10.9 x 12.5 x 5.4 cm

1



32.62

35.13



45 2709 36

schwarz matt
noir mat
10.9 x 12.5 x 5.4 cm

1



34.48

37.14



Passt auf bestehende horizontale Bohrlöcher im Abstand von 20 – 40 mm.

S'adapte aux trous déjà existants avec une distance de perçage de 20 – 40 mm

BIASCA

| EAN-Nr. no EAN | Artikel Nr. no d'article | Beschreibung description | VPE ce | VE ue | UVP pro Stk. PVC CHF excl. | UVP pro Stk. PVC CHF incl. |
|-------------------|-----------------------------|-----------------------------|-----------|----------|----------------------------------|----------------------------------|
|-------------------|-----------------------------|-----------------------------|-----------|----------|----------------------------------|----------------------------------|

| Seifenschale Biasca | Porte-savonnette Biasca | | | | | |
|---------------------|-------------------------|--|--|--|--|--|
|---------------------|-------------------------|--|--|--|--|--|



45 6000 31

frosted
Ø 56 / 111 mm ; 40 mm

1



10.81

11.64

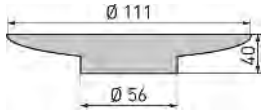

Passt zur Serie:
Biasca
Va pour la série:
Biasca

NEW

| Glasseifenspender Biasca | Distributeur de savon Biasca | | | | | |
|--------------------------|------------------------------|--|--|--|--|--|
|--------------------------|------------------------------|--|--|--|--|--|



45 2709 07

verchromt
chromé
10.7 x 7.2 x 16.5 cm ; 150 ml

1



39.14

42.16



45 2709 37

schwarz matt
noir mat
10.7 x 7.2 x 16.5 cm ; 150 ml

1



41.01

44.16

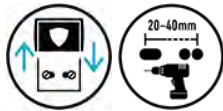

Passt auf bestehende horizontale
Bohrlöcher im Abstand von 20 –
40 mm.
S'adapte aux trous déjà existants
avec une distance de perçage de
20 – 40 mm

| Ersatzseifenspender | Distributeur de savon recharge | | | | | |
|---------------------|--------------------------------|--|--|--|--|--|
|---------------------|--------------------------------|--|--|--|--|--|



45 5941 56

frosted
verre frosted
150 ml

1



14.82

15.96



BIASCA

| EAN-Nr. no EAN | Artikel Nr. no d'article | Beschreibung description | VPE ce | VE ue | UVP pro Stk. PVC CHF excl. | UVP pro Stk. PVC CHF incl. |
|-------------------|-----------------------------|-----------------------------|-----------|----------|----------------------------------|----------------------------------|
|-------------------|-----------------------------|-----------------------------|-----------|----------|----------------------------------|----------------------------------|

Ersatzpumpe

Pompe de rechange



| | | | | | | |
|--|-------------------|-------------------------|---|---|-------------|--------------|
|  7 611038 089528 | 45 5941 57 | Kunststoff plastique | 1 |  | 9.97 | 10.74 |
|--|-------------------|-------------------------|---|---|-------------|--------------|

NEW









Badetuchstange Biasca

Porte-serviette Biasca



Passt auf bestehende horizontale Bohrlöcher im Abstand von 20 – 40 mm.

S'adapte aux trous déjà existants avec une distance de perçage de 20 – 40 mm

| | | | | | | |
|--|-------------------|--|---|---|--------------|--------------|
|  7 611038 173746 | 45 2709 08 | verchromt chromé 7.7 x 87 x 4 cm | 1 |  | 58.71 | 63.23 |
|  7 611038 173753 | 45 2709 09 | verchromt chromé 7.7 x 67.9 x 4 cm | 1 |  | 52.19 | 56.21 |
|  7 611038 190415 | 45 2709 38 | schwarz matt noir mat 7.7 x 87 x 4 cm | 1 |  | 60.58 | 65.24 |
|  7 611038 190422 | 45 2709 39 | schwarz matt noir matt 7.7 x 67.9 x 4 cm | 1 |  | 54.05 | 58.22 |



NEW





Doppelbadetuchstange Biasca

Porte-serviette double Biasca



Passt auf bestehende horizontale Bohrlöcher im Abstand von 20 – 40 mm.

S'adapte aux trous déjà existants avec une distance de perçage de 20 – 40 mm

| | | | | | | |
|--|-------------------|--|---|---|--------------|--------------|
|  7 611038 173760 | 45 2709 10 | verchromt chromé 12.7 x 68 x 4 cm | 1 |  | 76.42 | 82.30 |
|  7 611038 190439 | 45 2709 40 | schwarz matt noir mat 12.7 x 68 x 4 cm | 1 |  | 78.28 | 84.31 |



BIASCA

| EAN-Nr. no EAN | Artikel Nr. no d'article | Beschreibung description | VPE ce | VE ue | UVP pro Stk. PVC CHF excl. | UVP pro Stk. PVC CHF incl. |
|-------------------|-----------------------------|-----------------------------|-----------|----------|----------------------------------|----------------------------------|
|-------------------|-----------------------------|-----------------------------|-----------|----------|----------------------------------|----------------------------------|

NEW

Handtuchhalter 2-armig Biasca

Porte-serviette 2 bras Biasca



45 2709 11

verchromt
chromé
42 cm

1



76.42

82.30



45 2709 41

schwarz matt
noir mat
42 cm

1



78.28

84.31

Passt auf bestehende horizontale Bohrlöcher im Abstand von 20 – 40 mm.

S'adapte aux trous déjà existants avec une distance de perçage de 20 – 40 mm

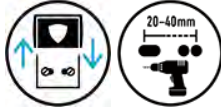

NEW

Handtuchring Biasca

Anneau porte-serviette Biasca



45 2709 13

verchromt
chromé
5.4 x 22.5 x 15.5 cm

1



45.67

49.18



45 2709 42

schwarz matt
noir mat
5.4 x 22.5 x 15.5 cm

1



47.53

51.19

Passt auf bestehende horizontale Bohrlöcher im Abstand von 20 – 40 mm.

S'adapte aux trous déjà existants avec une distance de perçage de 20 – 40 mm

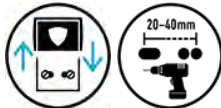

NEW

Haken Biasca

Crochet Biasca



45 2709 14

verchromt
chromé
5.4 x 4 x 7 cm

1



19.11

20.58



45 2709 43

schwarz matt
noir mat
5.4 x 4 x 7 cm

1



21.43

23.09



Passt auf bestehende horizontale Bohrlöcher im Abstand von 20 – 40 mm.

S'adapte aux trous déjà existants avec une distance de perçage de 20 – 40 mm



BIASCA



| EAN-Nr. <i>no EAN</i> | Artikel Nr. <i>no d'article</i> | Beschreibung <i>description</i> | VPE <i>ce</i> | VE <i>ue</i> | UVP pro Stk. <i>PVC</i> CHF excl. | UVP pro Stk. <i>PVC</i> CHF incl. |
|--------------------------|------------------------------------|------------------------------------|------------------|-----------------|---|---|
|--------------------------|------------------------------------|------------------------------------|------------------|-----------------|---|---|

| Ablagekonsole Biasca | | Tablette Biasca | | | | |
|---|--|------------------------|--|---|---|---------------------------|
|  |  7 611038 173838 | 45 2709 16 | verchromt <i>chromé</i> 13.3 x 70 x 4 cm | 1 |  | 76.42 82.30 |

Passt auf bestehende horizontale Bohrlöcher im Abstand von 20 – 40 mm.

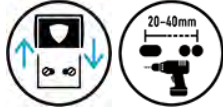
S'adapte aux trous déjà existants avec une distance de perçage de 20 – 40 mm



| Befestigungsset Biasca | | Jeu de fixation Biasca | | | | |
|-------------------------------|--|-------------------------------|---|---|---|---------------------------|
| |  7 611038 173890 | 45 2709 22 | mit Platte, Schrauben & Dübeln <i>avec vises & chevilles</i> | 1 |  | 10.90 11.74 |



QUINTO

| | EAN-Nr. <i>no EAN</i> | Artikel Nr. <i>no d'article</i> | Beschreibung <i>description</i> | VPE <i>ce</i> | VE <i>ue</i> | UVP pro Stk. <i>PVC</i> CHF excl. | UVP pro Stk. <i>PVC</i> CHF incl. |
|--|--------------------------|------------------------------------|------------------------------------|------------------|-----------------|---|---|
|--|--------------------------|------------------------------------|------------------------------------|------------------|-----------------|---|---|

NEW

WC-Bürstengarnitur Quinto

Garniture de WC Quinto



45 2713 01

schwarz matt
noir mat
12 x 9.3 x 37.3 cm

1



60.58

65.24



45 2713 02

verchromt
chromé
12 x 9.3 x 37.3 cm

1



54.05

58.22



Ankleben oder anschrauben!
Klebstoff unter
Nr. 45 1302 98 erhältlich.
Coller ou visser!
Mastic-colle voire
sous No. 45 1302 98.

NEW

WC-Ersatzbürste m/Stiel Quinto

Brosse rechange Quinto



45 2713 36

schwarz matt
noir
Ø 75 mm

1



9.27

9.99



45 2713 34

verchromt
chromé
Ø 75 mm

1



8.11

8.73

Ersatzglas WC-Garnitur Quinto

Pot de rechange Quinto



45 2713 32

frosted
9.4 x 9.4 x 14 cm

1



13.98

15.06

QUINTO





| EAN-Nr. no EAN | Artikel Nr. no d'article | Beschreibung description | VPE ce | VE ue | UVP pro Stk. PVC CHF excl. | UVP pro Stk. PVC CHF incl. |
|-------------------|-----------------------------|-----------------------------|-----------|----------|----------------------------------|----------------------------------|
|-------------------|-----------------------------|-----------------------------|-----------|----------|----------------------------------|----------------------------------|

NEW

WC-Papierhalter Quinto

Porte-papier WC Quinto



| | | | | | | |
|--|-------------------|---|---|---|--------------|--------------|
|  7 611038 190002 | 45 2713 03 | schwarz matt <i>noir mat</i> 14 x 4.8 x 14.5 cm | 1 |  | 41.47 | 44.67 |
|  7 611038 190019 | 45 2713 04 | verchromt <i>chromé</i> 14 x 4.8 x 14.5 cm | 1 |  | 40.54 | 43.66 |







Ankleben oder anschrauben!
Klebstoff unter
Nr. 45 1302 98 erhältlich.
Coller ou visser!
Mastic-colle voire
sous No. 45 1302 98.

NEW

Glashalter einfach Quinto

Porte-verre simple Quinto



| | | | | | | |
|--|-------------------|--|---|---|--------------|--------------|
|  7 611038 190026 | 45 2713 05 | schwarz matt <i>noir mat</i> 7 x 9.6 x 10 cm | 1 |  | 36.35 | 39.14 |
|  7 611038 190033 | 45 2713 06 | verchromt <i>chromé</i> 7 x 9.6 x 10 cm | 1 |  | 35.41 | 38.14 |







Ankleben oder anschrauben!
Klebstoff unter
Nr. 45 1302 98 erhältlich.
Coller ou visser!
Mastic-colle voire
sous No. 45 1302 98.

NEW

Doppelglashalter Quinto

Porte-verre double Quinto



| | | | | | | |
|--|-------------------|---|---|---|--------------|--------------|
|  7 611038 190040 | 45 2713 07 | schwarz matt <i>noir mat</i> 17.8 x 9.6 x 10 cm | 1 |  | 72.69 | 78.29 |
|  7 611038 190057 | 45 2713 08 | verchromt <i>chromé</i> 17.8 x 9.6 x 10 cm | 1 |  | 66.17 | 71.26 |





Ankleben oder anschrauben!
Klebstoff unter
Nr. 45 1302 98 erhältlich.
Coller ou visser!
Mastic-colle voire
sous No. 45 1302 98.

QUINTO

| EAN-Nr. no EAN | Artikel Nr. no d'article | Beschreibung description | VPE ce | VE ue | UVP pro Stk. PVC CHF excl. | UVP pro Stk. PVC CHF incl. |
|-------------------|-----------------------------|-----------------------------|-----------|----------|----------------------------------|----------------------------------|
|-------------------|-----------------------------|-----------------------------|-----------|----------|----------------------------------|----------------------------------|

| Ersatz Zahnglas Quinto | | Verre à dents rechange Quinto | | | | |
|------------------------|--|-------------------------------|--|--|--|--|
|------------------------|--|-------------------------------|--|--|--|--|







| | | | | | | |
|--|-------------------|------------------------------|---|---|-------------|-------------|
|  7 611038 190217 | 45 2713 31 | frosted 6.8 x 6.8 x 10 cm | 1 |  | 9.27 | 9.99 |
|--|-------------------|------------------------------|---|---|-------------|-------------|

NEW

| Glasseifenhalter Quinto | | Porte-savonnette verre Quinto | | | | |
|-------------------------|--|-------------------------------|--|--|--|--|
|-------------------------|--|-------------------------------|--|--|--|--|





| | | | | | | |
|--|-------------------|---|---|---|--------------|--------------|
|  7 611038 190064 | 45 2713 09 | schwarz matt <i>noir mat</i> 12 x 10.3 x 4.8 cm | 1 |  | 36.35 | 39.14 |
|  7 611038 190071 | 45 2713 10 | verchromt <i>chromé</i> 12 x 10.3 x 4.8 cm | 1 |  | 35.41 | 38.14 |

Ankleben oder anschrauben!
Klebstoff unter
Nr. 45 1302 98 erhältlich.
Coller ou visser!
Mastic-colle voire
sous No. 45 1302 98.



| Ersatz Seifenschale Quinto | | Porte-savonnette rechan. Quinto | | | | |
|----------------------------|--|---------------------------------|--|--|--|--|
|----------------------------|--|---------------------------------|--|--|--|--|







| | | | | | | |
|--|-------------------|--------------------------------|---|---|-------------|-------------|
|  7 611038 190200 | 45 2713 30 | frosted 11.9 x 8.4 x 2.9 cm | 1 |  | 9.27 | 9.99 |
|--|-------------------|--------------------------------|---|---|-------------|-------------|

NEW

| Glasseifenspender Quinto | | Distributeur de savon Quinto | | | | |
|--------------------------|--|------------------------------|--|--|--|--|
|--------------------------|--|------------------------------|--|--|--|--|







| | | | | | | |
|--|-------------------|---|---|---|--------------|--------------|
|  7 611038 190088 | 45 2713 11 | schwarz matt <i>noir mat</i> 11.1 x 7 x 16 cm | 1 |  | 52.19 | 56.21 |
|  7 611038 190095 | 45 2713 12 | verchromt <i>chromé</i> 11.1 x 7 x 16 cm | 1 |  | 49.39 | 53.20 |











Ankleben oder anschrauben!
Klebstoff unter
Nr. 45 1302 98 erhältlich.
Coller ou visser!
Mastic-colle voire
sous No. 45 1302 98.

QUINTO

| EAN-Nr. no EAN | Artikel Nr. no d'article | Beschreibung description | VPE ce | VE ue | UVP pro Stk. PVC CHF excl. | UVP pro Stk. PVC CHF incl. |
|-------------------|-----------------------------|-----------------------------|-----------|----------|----------------------------------|----------------------------------|
|-------------------|-----------------------------|-----------------------------|-----------|----------|----------------------------------|----------------------------------|





| Ersatzpumpe Quinto | | Pompe de rechange Quinto | | | | | |
|---|--|--------------------------|-----------------------------|---|---|--------------|--------------|
|  |  7 611038 190231 | 45 2713 33 | verchromt <i>chromé</i> | 1 |  | 12.67 | 13.65 |
| |  7 611038 561192 | 45 2713 37 | schwarz matt <i>noir</i> | 1 |  | 13.98 | 15.06 |

NEW

| Badetuchstange Quinto | | Porte-serviette Quinto | | | | | |
|--|---|------------------------|--|---|--|--------------|--------------|
|  Ankleben oder anschrauben! Klebstoff unter Nr. 45 1302 98 erhältlich. <i>Coller ou visser!</i> <i>Mastic-colle voire</i> <i>sous No. 45 1302 98.</i> |  7 611038 190101 | 45 2713 13 | schwarz matt <i>noir mat</i> 61.8 x 5.4 x 4.8 cm | 1 |  | 60.58 | 65.24 |
| |  7 611038 190125 | 45 2713 15 | schwarz matt <i>noir mat</i> 84.8 x 5.4 x 4.8 cm | 1 |  | 72.69 | 78.29 |
| |  7 611038 190118 | 45 2713 14 | verchromt <i>chromé</i> 61.8 x 5.4 x 4.8 cm | 1 |  | 54.05 | 58.22 |
| |  7 611038 190132 | 45 2713 16 | verchromt <i>chromé</i> 84.8 x 5.4 x 4.8 cm | 1 |  | 66.17 | 71.26 |



NEW

| Doppelbadetuchstange Quinto | | Porte-serviette double Quinto | | | | | |
|--|--|-------------------------------|--|---|---|--------------|--------------|
|  Ankleben oder anschrauben! Klebstoff unter Nr. 45 1302 98 erhältlich. <i>Coller ou visser!</i> <i>Mastic-colle voire</i> <i>sous No. 45 1302 98.</i> |  7 611038 190149 | 45 2713 17 | schwarz matt <i>noir mat</i> 61.8 x 12 x 4.8 | 1 |  | 66.17 | 71.26 |
| |  7 611038 190156 | 45 2713 18 | verchromt <i>chromé</i> 61.8 x 12 x 4.8 | 1 |  | 61.51 | 66.25 |



QUINTO

| EAN-Nr. no EAN | Artikel Nr. no d'article | Beschreibung description | VPE ce | VE ue | UVP pro Stk. PVC CHF excl. | UVP pro Stk. PVC CHF incl. |
|-------------------|-----------------------------|-----------------------------|-----------|----------|----------------------------------|----------------------------------|
|-------------------|-----------------------------|-----------------------------|-----------|----------|----------------------------------|----------------------------------|

NEW

Handtuchhalter 3-armig Quinto

Porte-serviette 3 bras Quinto



45 2713 19

schwarz matt
noir mat
38 x 4.8 x 9.6 cm

1



72.69

78.29



45 2713 20

verchromt
chromé
38 x 4.8 x 9.6 cm

1



66.17

71.26

Ankleben oder anschrauben!
Klebstoff unter
Nr. 45 1302 98 erhältlich.
Coller ou visser!
Mastic-colle voire
sous No. 45 1302 98.



NEW

Haken Quinto

Crochet Quinto



45 2713 21

schwarz matt
noir mat
5.4 x 4.8 x 5.1 cm

1



27.49

29.61



45 2713 22

verchromt
chromé
5.4 x 4.8 x 5.1 cm

1



26.09

28.10

Ankleben oder anschrauben!
Klebstoff unter
Nr. 45 1302 98 erhältlich.
Coller ou visser!
Mastic-colle voire
sous No. 45 1302 98.



NEW

digluu 2K Klebeset

digluu Jeux de fixation



45 1302 98

für 2 Anwendungen
pour 2 utilisations

1



18.59

20.02

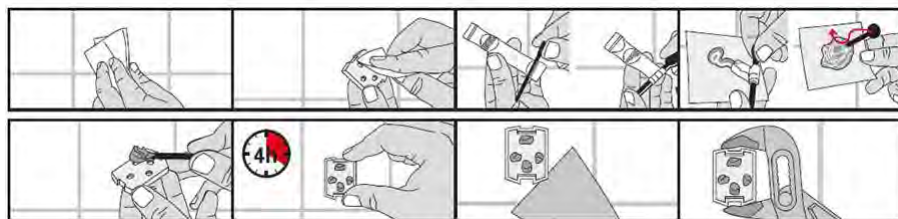

Für 2 Anwendungen
pour 2 utilisations

SOFIA

| EAN-Nr. no EAN | Artikel Nr. no d'article | Beschreibung description | VPE ce | VE ue | UVP pro Stk. PVC CHF excl. | UVP pro Stk. PVC CHF incl. |
|-------------------|-----------------------------|-----------------------------|-----------|----------|----------------------------------|----------------------------------|
|-------------------|-----------------------------|-----------------------------|-----------|----------|----------------------------------|----------------------------------|

WC-Bürstengarnitur Sofia

Garniture de WC Sofia



45 2707 01

verchromt
chromé
10.5 x 15 x 38 cm

12



44.27

47.68



Ankleben oder anschrauben!
Klebstoff unter
Nr. 45 2704 98 erhältlich.
Coller ou visser!
Mastic-colle voire
sous no. 45 2704 98.

WC-Ersatzbür. mit Stiel Sofia

Brosse de rechange Sofia



45 2704 21

verchromt
chromé
Ø 75 mm

10



20.04

21.58

Ersatzglas zu WC-Bürstengarn.

Pot de rechange



45 2705 24

frosted

36



18.45

19.87

WC-Papierhalter Sofia

Porte-papier WC Sofia



45 2707 02

verchromt
chromé
6.5 x 14.5 x 14.5 cm

48



39.61



42.66



Ankleben oder anschrauben!
Klebstoff unter
Nr. 45 2704 98 erhältlich.
Coller ou visser!
Mastic-colle voire
sous no. 45 2704 98.



SOFIA

| EAN-Nr. no EAN | Artikel Nr. no d'article | Beschreibung description | VPE ce | VE ue | UVP pro Stk. PVC CHF excl. | UVP pro Stk. PVC CHF incl. |
|-------------------|-----------------------------|-----------------------------|-----------|----------|----------------------------------|----------------------------------|
|-------------------|-----------------------------|-----------------------------|-----------|----------|----------------------------------|----------------------------------|

| Glashalter einfach Sofia | | Porte-verre simple Sofia | | | | | |
|---|--|--------------------------|--|----|---|-------|-------|
|  |  7 611038 141011 | 45 2707 04 | verchromt chromé 8 x 12 x 9.5 cm | 24 |  | 30.29 | 32.62 |





Ankleben oder anschrauben!
Klebstoff unter
Nr. 45 2704 98 erhältlich.
Coller ou visser!
Mastic-colle voire
sous no. 45 2704 98.

| Doppelglashalter Sofia | | Porte-verre double Sofia | | | | | |
|--|--|--------------------------|--|----|---|-------|-------|
|  |  7 611038 141028 | 45 2707 05 | verchromt chromé 8 x 18 x 9.5 cm | 20 |  | 39.61 | 42.66 |



Ankleben oder anschrauben!
Klebstoff unter
Nr. 45 2704 98 erhältlich.
Coller ou visser!
Mastic-colle voire
sous no. 45 2704 98.

| Zahnglas | | Verre à dents | | | | | |
|---|--|---------------|---------------------------------|---|---|-------|-------|
|  |  7 611038 141417 | 45 2707 32 | frosted Ø 55 / 69 mm ; 96 mm | 1 |  | 12.30 | 13.25 |



Passt zur Serie:
Sofia
Va pour la série:
Sofia

| Ersatzring zu Glashalter Sofia | | Anneau de rechange Sofia | | | | | |
|--------------------------------|--|--------------------------|-------------------------|---|---|------|------|
| |  7 611038 141387 | 45 2707 36 | Kunststoff plastique | 1 |  | 2.98 | 3.21 |

SOFIA

| EAN-Nr. no EAN | Artikel Nr. no d'article | Beschreibung description | VPE ce | VE ue | UVP pro Stk. PVC CHF excl. | UVP pro Stk. PVC CHF incl. |
|-------------------|-----------------------------|-----------------------------|-----------|----------|----------------------------------|----------------------------------|
|-------------------|-----------------------------|-----------------------------|-----------|----------|----------------------------------|----------------------------------|

Glasseifenhalter Sofia

Porte-savonnette/ verre Sofia



45 2707 06

verchromt
chromé
9 x 15.5 x 4 cm

24



30.29

32.62



Ankleben oder anschrauben!
Klebstoff unter
Nr. 45 2704 98 erhältlich.
Coller ou visser!
Mastic-colle voire
sous no. 45 2704 98.

Seifenschale Sofia

Porte-savonnette Sofia



45 2707 31

frosted

1



16.87

18.17

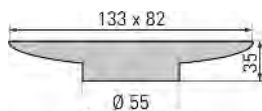

Passt zur Serie:
Sofia
Va pour la série:
Sofia

Glasseifenspender Sofia

Distributeur de savon Sofia



45 2707 07

verchromt
chromé
9 x 12 x 15.5 cm

24



33.55

36.13



Ankleben oder anschrauben!
Klebstoff unter
Nr. 45 2704 98 erhältlich.
Coller ou visser!
Mastic-colle voire
sous no. 45 2704 98.

Ersatzseifenspender Sofia

Distributeur de savon Sofia



45 2707 33

frosted

1



20.50



22.08

SOFIA

| EAN-Nr. no EAN | Artikel Nr. no d'article | Beschreibung description | VPE ce | VE ue | UVP pro Stk. PVC CHF excl. | UVP pro Stk. PVC CHF incl. |
|-------------------|-----------------------------|-----------------------------|-----------|----------|----------------------------------|----------------------------------|
|-------------------|-----------------------------|-----------------------------|-----------|----------|----------------------------------|----------------------------------|

Badetuchstange Sofia

Porte-serviette Sofia



| | | | | | | | |
|---|--|-------------------|-----------------------------|----|---|--------------|--------------|
|  |  7 611038 141066 | 45 2707 09 | verchromt chromé 61CM | 24 |  | 39.61 | 42.66 |
|---|--|-------------------|-----------------------------|----|---|--------------|--------------|



Ankleben oder anschrauben!
Klebstoff unter
Nr. 45 2704 98 erhältlich.
Coller ou visser!
Mastic-colle voire
sous no. 45 2704 98.

Doppelbadetuchstange Sofia

Porte-serviette double Sofia



| | | | | | | | |
|---|--|-------------------|------------------------------|----|---|--------------|--------------|
|  |  7 611038 141073 | 45 2707 10 | verchromt chromé 61 cm | 12 |  | 51.26 | 55.20 |
|---|--|-------------------|------------------------------|----|---|--------------|--------------|



Ankleben oder anschrauben!
Klebstoff unter
Nr. 45 2704 98 erhältlich.
null

Handtuchhalter 2-armig Sofia

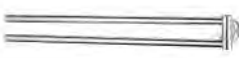
Porte-serviette à 2 bras Sofia

| | | | | | | | |
|---|--|-------------------|------------------------------|----|---|--------------|--------------|
|  |  7 611038 162948 | 45 2707 11 | verchromt chromé 44 cm | 24 |  | 43.34 | 46.67 |
|---|--|-------------------|------------------------------|----|---|--------------|--------------|

Nur zum Anschrauben!
Seulement à visser!



SOFIA

| | EAN-Nr. no EAN | Artikel Nr. no d'article | Beschreibung description | VPE ce | VE ue | UVP pro Stk. PVC CHF excl. | UVP pro Stk. PVC CHF incl. |
|--|-------------------|-----------------------------|-----------------------------|-----------|----------|----------------------------------|----------------------------------|
|--|-------------------|-----------------------------|-----------------------------|-----------|----------|----------------------------------|----------------------------------|

Handtuchring Sofia

Anneau porte-serviette Sofia



45 2707 13

verchromt
chromé
6.5 x 16 x 16.5 cm

35



27.03

29.11



Ankleben oder anschrauben!
Klebstoff unter
Nr. 45 2704 98 erhältlich.
Coller ou visser!
Mastic-colle voire
sous no. 45 2704 98.

Doppelhaken Sofia

Crochet double Sofia



45 2707 15

verchromt
chromé
5 x 7 x 4 cm

100



18.64

20.07



Ankleben oder anschrauben!
Klebstoff unter
Nr. 45 2704 98 erhältlich.
Coller ou visser!
Mastic-colle voire
sous no. 45 2704 98.

Föhnhalter Sofia

Support sèche-cheveux Sofia



45 2707 17

verchromt
chromé
10 x 6 x 13 cm

24



46.60

50.19



Ankleben oder anschrauben!
Klebstoff unter
Nr. 45 2704 98 erhältlich.
Coller ou visser!
Mastic-colle voire
sous no. 45 2704 98.

SOFIA

| EAN-Nr. <i>no EAN</i> | Artikel Nr. <i>no d'article</i> | Beschreibung <i>description</i> | VPE <i>ce</i> | VE <i>ue</i> | UVP pro Stk. <i>PVC</i> CHF excl. | UVP pro Stk. <i>PVC</i> CHF incl. |
|--------------------------|------------------------------------|------------------------------------|------------------|-----------------|---|---|
|--------------------------|------------------------------------|------------------------------------|------------------|-----------------|---|---|

Befestigungsset Sofia

Jeu de fixation Sofia

| | | | | | | |
|--|-------------------|---|---|---|-------------|-------------|
|  7 611038 141400 | 45 2707 30 | mit Schrauben & Dübeln <i>avec vises & chevilles</i> | 1 |  | 6.99 | 7.53 |
|--|-------------------|---|---|---|-------------|-------------|

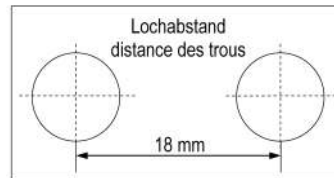

Klebstoff-Masse

Mastic-colle Sofia

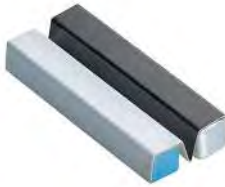

| | | | | | | |
|--|-------------------|--|----|---|--------------|--------------|
|  7 611038 109325 | 45 2704 98 | | 25 |  | 27.49 | 29.61 |
|--|-------------------|--|----|---|--------------|--------------|



ROMA

| EAN-Nr. no EAN | Artikel Nr. no d'article | Beschreibung description | VPE ce | VE ue | UVP pro Stk. PVC CHF excl. | UVP pro Stk. PVC CHF incl. |
|-------------------|-----------------------------|-----------------------------|-----------|----------|----------------------------------|----------------------------------|
|-------------------|-----------------------------|-----------------------------|-----------|----------|----------------------------------|----------------------------------|

WC-Bürstengarnitur Roma

Garniture de WC Roma



45 2704 05

verchromt
chromé
12 x 15 x 38 cm

12



68.03

73.27



Ankleben oder anschrauben!
Klebstoff unter
Nr. 45 2704 98 erhältlich.
Coller ou visser!
Mastic-colle voire
sous no. 45 2704 98.

WC-Ersatzbür. mit Stiel Sofia

Brosse de rechange Sofia



45 2704 21

verchromt
chromé
Ø 75 mm

10



20.04

21.58

Ersatzglas zu WC-Bürstengarn.

Pot de rechange



45 2705 24

frosted

36



18.45

19.87

WC-Papierhalt. mit Deckel Roma

Porte-papier avec couverc Roma



45 2704 01

verchromt
chromé
13.5 x 9.5 x 10 cm

48



39.14

42.16



Ankleben oder anschrauben!
Klebstoff unter
Nr. 45 2704 98 erhältlich.
Coller ou visser!
Mastic-colle voire
sous no. 45 2704 98.

ROMA

| EAN-Nr. no EAN | Artikel Nr. no d'article | Beschreibung description | VPE ce | VE ue | UVP pro Stk. PVC CHF excl. | UVP pro Stk. PVC CHF incl. |
|-------------------|-----------------------------|-----------------------------|-----------|----------|----------------------------------|----------------------------------|
|-------------------|-----------------------------|-----------------------------|-----------|----------|----------------------------------|----------------------------------|

Glashalter einfach Roma

Porte-verre simple Roma



45 2704 04

verchromt
chromé
7 x 11 x 9.5 cm

24



29.36

31.62



Ankleben oder anschrauben!
Klebstoff unter
Nr. 45 2704 98 erhältlich.
Coller ou visser!
Mastic-colle voire
sous no. 45 2704 98.

Doppelglashalter Roma

Porte-verre double Roma



45 2704 09

verchromt
chromé
16 x 11 x 9.5 cm

20



32.15

34.63



Ankleben oder anschrauben!
Klebstoff unter
Nr. 45 2704 98 erhältlich.
Coller ou visser!
Mastic-colle voire
sous no. 45 2704 98.

Zahnglas Roma

Verre à dents Roma



45 2704 96

weiss frosted
blanc frosted
Ø 55 / 69 mm ; 96 mm

50



8.85



9.54



Passt zur Serie:
Roma
Va pour la série:
Roma



ROMA

| EAN-Nr. no EAN | Artikel Nr. no d'article | Beschreibung description | VPE ce | VE ue | UVP pro Stk. PVC CHF excl. | UVP pro Stk. PVC CHF incl. |
|-------------------|-----------------------------|-----------------------------|-----------|----------|----------------------------------|----------------------------------|
|-------------------|-----------------------------|-----------------------------|-----------|----------|----------------------------------|----------------------------------|

| Glasseifenhalter Roma | | Porte-savonnette/verre Roma | | | | | |
|---|--|-----------------------------|---|----|---|--------------|--------------|
|  |  7 611038 109264 | 45 2704 03 | verchromt chromé 13.5 x 12 x 6 cm | 24 |  | 29.36 | 31.62 |



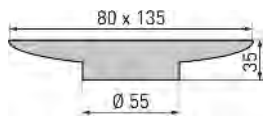

Ankleben oder anschrauben!
Klebstoff unter
Nr. 45 2704 98 erhältlich.
Coller ou visser!
Mastic-colle voire
sous no. 45 2704 98.

| Seifenschale Roma | | Porte-savonnette Roma | | | | | |
|---|--|-----------------------|--|----|---|-------------|-------------|
|  |  7 611038 081645 | 45 2704 94 | weiss frosted blanc frosted Ø 55 / 80 x 135 mm ; 35 mm | 60 |  | 8.85 | 9.54 |



Passt zur Serie:
Roma
Va pour la série:
Roma

| Glasseifenspender Roma | | Distributeur de savon Roma | | | | | |
|---|--|----------------------------|---|----|---|--------------|--------------|
|  |  7 611038 109257 | 45 2704 02 | verchromt chromé 7 x 11.5 x 15.5 cm | 24 |  | 41.01 | 44.16 |



Ankleben oder anschrauben!
Klebstoff unter
Nr. 45 2704 98 erhältlich.
Coller ou visser!
Mastic-colle voire
sous no. 45 2704 98.

ROMA

| | EAN-Nr. no EAN | Artikel Nr. no d'article | Beschreibung description | VPE ce | VE ue | UVP pro Stk. PVC CHF excl. | UVP pro Stk. PVC CHF incl. |
|--|-------------------|-----------------------------|-----------------------------|-----------|----------|----------------------------------|----------------------------------|
|--|-------------------|-----------------------------|-----------------------------|-----------|----------|----------------------------------|----------------------------------|



| | | | | | | | |
|---------------------------------|--------------------------------------|--|--|--|--|--|--|
| Ersatzseifenspender Roma | Distributeur de rechange Roma | | | | | | |
|---------------------------------|--------------------------------------|--|--|--|--|--|--|



| | | | | | | |
|---|-------------------|-------------|----|---|--------------|--------------|
|  | 45 2704 22 | Ø 7 x 15 cm | 10 |  | 24.23 | 26.10 |
|---|-------------------|-------------|----|---|--------------|--------------|

| | | | | | | | |
|----------------------------|-----------------------------|--|--|--|--|--|--|
| Badetuchstange Roma | Porte-serviette Roma | | | | | | |
|----------------------------|-----------------------------|--|--|--|--|--|--|





| | | | | | | |
|---|-------------------|------------------------------|----|---|--------------|--------------|
|  | 45 2704 06 | verchromt chromé 61 cm | 24 |  | 68.03 | 73.27 |
|---|-------------------|------------------------------|----|---|--------------|--------------|

Ankleben oder anschrauben!
Klebstoff unter
Nr. 45 2704 98 erhältlich.
Coller ou visser!
Mastic-colle voire
sous no. 45 2704 98.



| | | | | | | | |
|------------------------------------|--------------------------------------|--|--|--|--|--|--|
| Handtuchhalter 2-armig Roma | Porte-serviette à 2 bras Roma | | | | | | |
|------------------------------------|--------------------------------------|--|--|--|--|--|--|





| | | | | | | |
|---|-------------------|------------------------------|----|---|--------------|--------------|
|  | 45 2704 07 | verchromt chromé 48 cm | 24 |  | 63.37 | 68.25 |
|---|-------------------|------------------------------|----|---|--------------|--------------|

Nur zum anschrauben!
Seulement à visser!

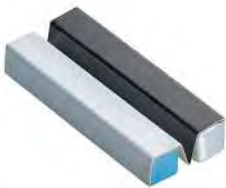

| | | | | | | | |
|------------------------|---------------------------|--|--|--|--|--|--|
| Klebstoff-Masse | Mastic-colle Sofia | | | | | | |
|------------------------|---------------------------|--|--|--|--|--|--|





| | | | | | | |
|---|-------------------|--|----|---|--------------|--------------|
|  | 45 2704 98 | | 25 |  | 27.49 | 29.61 |
|---|-------------------|--|----|---|--------------|--------------|





NAPOLI



| | EAN-Nr. no EAN | Artikel Nr. no d'article | Beschreibung description | VPE ce | VE ue | UVP pro Stk. PVC CHF excl. | UVP pro Stk. PVC CHF incl. |
|--|-------------------|-----------------------------|-----------------------------|-----------|----------|----------------------------------|----------------------------------|
|--|-------------------|-----------------------------|-----------------------------|-----------|----------|----------------------------------|----------------------------------|

| WC-Papierhalter mit Deckel | | Porte-papier WC avec couvercle | | | | | |
|---|--|--------------------------------|---|----|---|-------|-------|
|  |  7 611038 109479 | 45 2703 30 | verchromt chromé 13 x 10.5 x 8.5 cm | 24 |  | 28.89 | 31.12 |





| Reserverollenhalter | | Support pour réserve papier WC | | | | | |
|---|--|--------------------------------|--|----|---|-------|-------|
|  |  7 611038 109509 | 45 2703 31 | verchromt chromé 5.5 x 7 x 17.5 cm | 24 |  | 31.69 | 34.13 |



| Doppelglashalter | | Porte-verre double | | | | | |
|---|---|--------------------|---|----|--|-------|-------|
|  |  7 611038 109493 | 45 2703 33 | verchromt chromé 16.5 x 11.5 x 9.5 cm | 24 |  | 35.41 | 38.14 |





| Zahnglas | | Verre à dents | | | | | |
|---|--|---------------|--|---|---|-------|-------|
|  |  7 611038 007942 | 46 1127 01 | glasklar verre claire Ø 58 / 67 mm ; 96 mm | 6 |  | 14.26 | 15.36 |





Passt zu Serien:
Tenero, Napoli
Va pour pour les séries:
Tenero, Napoli

NAPOLI



| | EAN-Nr. no EAN | Artikel Nr. no d'article | Beschreibung description | VPE ce | VE ue | UVP pro Stk. PVC CHF excl. | UVP pro Stk. PVC CHF incl. |
|--|-------------------|-----------------------------|-----------------------------|-----------|----------|----------------------------------|----------------------------------|
|--|-------------------|-----------------------------|-----------------------------|-----------|----------|----------------------------------|----------------------------------|

| Glaseifenspender | | Distributeur de savon en verre | | | | | |
|---|--|--------------------------------|---|----|---|--------------|--------------|
|  |  7 611038 109486 | 45 2703 32 | verchromt chromé 7 x 11.5 x 16 cm | 24 |  | 36.35 | 39.14 |





| Handtuchring | | Anneau porte-serviette | | | | | |
|---|--|------------------------|---|----|---|--------------|--------------|
|  |  7 611038 109523 | 45 2703 36 | verchromt chromé 15.5 x 3 x 18.5 cm | 24 |  | 27.03 | 29.11 |



| Badetuchstange | | Porte-serviette | | | | | |
|---|--|-------------------|------------------------------|----|---|--------------|--------------|
|  |  7 611038 109462 | 45 2703 35 | verchromt chromé 61 cm | 24 |  | 47.53 | 51.19 |



| Ersatzbefestigungsplatte | | Jeu de fixation | | | | | |
|--------------------------|--|-------------------|--|---|---|--------------|--------------|
| |  7 611038 109554 | 45 2703 40 | mit Schrauben & Dübeln avec vises & chevilles | 1 |  | 10.81 | 11.64 |

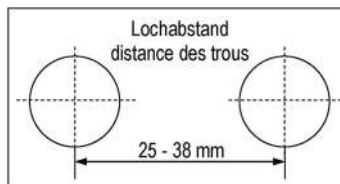

ACCESSOIRES

| EAN-Nr. no EAN | Artikel Nr. no d'article | Beschreibung description | VPE ce | VE ue | UVP pro Stk. PVC CHF excl. | UVP pro Stk. PVC CHF incl. |
|-------------------|-----------------------------|-----------------------------|-----------|----------|----------------------------------|----------------------------------|
|-------------------|-----------------------------|-----------------------------|-----------|----------|----------------------------------|----------------------------------|

NEW

Halter für Stellaccessoires

Support d'accessoires



45 2797 00

verchromt
chromé
8.8 x 8.8 x 3.0 cm

1



22.37

24.09



Ankleben oder anschrauben!
Klebstoff unter
Nr. 45 1302 98 erhältlich.
Coller ou visser!
Mastic-colle voire
sous No. 45 1302 98.



NEW

WC-Papierhalter

Porte-papier WC



45 2797 01

verchromt
chromé
14 x 7.5 x 10 cm

1



42.40

45.67



Ankleben oder anschrauben!
Klebstoff unter
Nr. 45 1302 98 erhältlich.
Coller ou visser!
Mastic-colle voire
sous No. 45 1302 98.



digluu 2K Klebeset

digluu Jeux de fixation



45 1302 98

für 2 Anwendungen
pour 2 utilisations

1



18.59

20.02

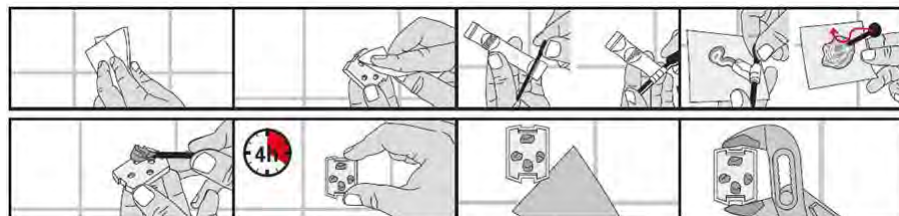

Für 2 Anwendungen
pour 2 utilisations

ACCESSOIRES

| | EAN-Nr. no EAN | Artikel Nr. no d'article | Beschreibung description | VPE ce | VE ue | UVP pro Stk. PVC CHF excl. | UVP pro Stk. PVC CHF incl. |
|--|-------------------|-----------------------------|-----------------------------|-----------|----------|----------------------------------|----------------------------------|
|--|-------------------|-----------------------------|-----------------------------|-----------|----------|----------------------------------|----------------------------------|

WC-Papierhalter mit Deckel

Porte-papier WC avec couvercle



45 2702 06

chrom
chromé
13 x 8.5 x 8 cm

1



34.02

36.64



Badetuchstange

Porte-serviette



45 2709 18

chrom
chromé
61 cm

1



48.46

52.19



45 2709 19

chrom
chromé
75 cm

1



54.05

58.22



Befestigungsset

Jeu de fixation



45 2702 14

zu Wannengriff mit Schale
pour Barre d'appui avec bac

1



10.90

11.74

Wannengriff

Barre d'appui



45 2709 20

chrom
chromé
25 cm

1



57.78

62.23



Ersatzbefestigungsplatte

Plaquette de fixation



45 2702 11

mit Schrauben & Dübeln
avec vises & chevilles

1



10.90

11.74

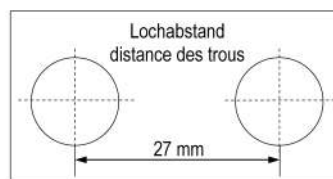

ACCESSOIRES

| EAN-Nr. no EAN | Artikel Nr. no d'article | Beschreibung description | VPE ce | VE ue | UVP pro Stk. PVC CHF excl. | UVP pro Stk. PVC CHF incl. |
|-------------------|-----------------------------|-----------------------------|-----------|----------|----------------------------------|----------------------------------|
|-------------------|-----------------------------|-----------------------------|-----------|----------|----------------------------------|----------------------------------|

Winkelwannengriff mit Schale

Barre d'appui angle avec bac



45 2709 21

Verchromt
chromé
37 x 11.5 x 24 cm

1



90.40

97.36

Kompatibel zur Serie Chic.
Compatible à la série Chic.

Wannenseifenschale

Porte-savonnette



35 0700 10

transparent
4.5 x 10.5 x 18.5 cm

6



7.83

8.43



35 0700 05

rauchtropas
topaze
4.5 x 10.5 x 18.5 cm

6



7.83

8.43



transparent
transparent

rauchtropas
topaze

Befestigungsset

Jeu de fixation



45 2702 14

zu Wannengriff mit Schale
pour Barre d'appui avec bac

1



10.90

11.74

Duschablage rechteckig

Bac à douche rectangulaire



45 1061 96

Inox poliert
inox poli
12.3 x 29 x 5.6 cm

1



54.99

59.22



Duschablage dreieckig

Bac à douche triangulaire



45 1061 97

Inox poliert
inox poli
20.6 x 20.6 x 5.6 cm

1



58.71

63.23



ACCESSOIRES

| | EAN-Nr. <i>no EAN</i> | Artikel Nr. <i>no d'article</i> | Beschreibung <i>description</i> | VPE <i>ce</i> | VE <i>ue</i> | UVP pro Stk. <i>PVC</i> CHF excl. | UVP pro Stk. <i>PVC</i> CHF incl. |
|--|--------------------------|------------------------------------|------------------------------------|------------------|-----------------|---|---|
|--|--------------------------|------------------------------------|------------------------------------|------------------|-----------------|---|---|

| | |
|----------------------------|----------------------|
| Kleiderhaken 1-fach | Patère simple |
|----------------------------|----------------------|



35 7016 24

verchromt
chromé
2 Stk/pcs

5



8.53

9.18



Zum Schrauben
À visser

| | |
|----------------------------|----------------------|
| Kleiderhaken 2-fach | Patère double |
|----------------------------|----------------------|



35 7016 23

verchromt
chromé
2 Stk/pcs

5























8.81

9.49



Zum Schrauben
À visser

LAGUNA

| | EAN-Nr. <i>no EAN</i> | Artikel Nr. <i>no d'article</i> | Beschreibung <i>description</i> | VPE <i>ce</i> | VE <i>ue</i> | UVP pro Stk. <i>PVC</i> CHF excl. | UVP pro Stk. <i>PVC</i> CHF incl. |
|--|--|------------------------------------|---|------------------|---|---|---|
| WC-Papierhalter mit Deckel Porte-papier WC avec couvercle | | | | | | | |
|  |  7 611038 109790 | 45 2703 72 | weiss <i>blanc</i> 15.5 x 6 x 14.5 cm | 8 |  | 18.08 | 19.47 |
| |  | | | | | | |
| Becherhalter Porte-verre | | | | | | | |
|  |  7 611038 109813 | 45 2703 75 | weiss <i>blanc</i> 10.5 x 12.5 x 9.5 cm | 10 |  | 13.79 | 14.86 |
| |  | | | | | | |
| Ersatzbecher Gobelet de rechange | | | | | | | |
|  |  7 611038 109882 | 45 2703 79 | weiss <i>blanc</i> Ø 71 / 55 mm ; 90 mm | 12 |  | 4.29 | 4.62 |
| |  | | | | | | |
| Seifenschale Porte-savonnette | | | | | | | |
|  |  7 611038 109806 | 45 2703 74 | weiss <i>blanc</i> 13.5 x 10 x 3 cm | 10 |  | 13.79 | 14.86 |
| |  | | | | | | |
| Doppelbadetuchstange Porte-serviette double | | | | | | | |
|  |  7 611038 109837 | 45 2703 73 | weiss <i>blanc</i> 55 cm | 7 |  | 23.76 | 25.59 |
| |  | | | | | | |

LAGUNA

| EAN-Nr. <i>no EAN</i> | Artikel Nr. <i>no d'article</i> | Beschreibung <i>description</i> | VPE <i>ce</i> | VE <i>ue</i> | UVP pro Stk. <i>PVC</i> CHF excl. | UVP pro Stk. <i>PVC</i> CHF incl. |
|--------------------------|------------------------------------|------------------------------------|------------------|-----------------|---|---|
|--------------------------|------------------------------------|------------------------------------|------------------|-----------------|---|---|

Handtuchhalter 2-armig

Porte-serviette à 2 bras



45 2703 71

weiss
blanc
40 cm

8



24.70

26.60



Ablagekonsole

Tablette



45 2703 70

weiss
blanc
54 x 14 cm

8





31.69

34.13



SMART



| EAN-Nr. no EAN | Artikel Nr. no d'article | Beschreibung description | VPE ce | VE ue | UVP pro Stk. PVC CHF excl. | UVP pro Stk. PVC CHF incl. |
|-------------------|-----------------------------|-----------------------------|-----------|----------|----------------------------------|----------------------------------|
|-------------------|-----------------------------|-----------------------------|-----------|----------|----------------------------------|----------------------------------|

| Wattedispenser SMART | | Distribut. d'ouate SMART | | | | | |
|---|--|--------------------------|--|---|---|--------------|--------------|
|  |  7 611038 096120 | 45 2027 07 | weiss / mit Tesa Powerstrips blanc / avec Tesa Powerstrips 8 x 6.5 x 25.5 cm | 1 |  | 12.95 | 13.95 |



Einfache Befestigung ohne zu bohren und spurlos ablösbar, dank der Tesa Powerstrips® Technologie

Fixation facile sans avoir à effectuer de perçage et facilement détachable grâce à la technologie Tesa Powerstrips®



| Duschwischer SMART | | Nett. cabines douche SMART | | | | | |
|---|--|----------------------------|---|---|---|--------------|--------------|
|  |  7 611038 096182 | 45 2027 13 | weiss / mit Tesa Powerstrips blanc / avec Tesa Powerstrips 18 x 5 x 28 cm | 3 |  | 11.46 | 12.35 |



Einfache Befestigung ohne zu bohren und spurlos ablösbar, dank der Tesa Powerstrips® Technologie

Fixation facile sans avoir à effectuer de perçage et facilement détachable grâce à la technologie Tesa Powerstrips®

SMART

| | EAN-Nr. <i>no EAN</i> | Artikel Nr. <i>no d'article</i> | Beschreibung <i>description</i> | VPE <i>ce</i> | VE <i>ue</i> | UVP pro Stk. <i>PVC</i> CHF excl. | UVP pro Stk. <i>PVC</i> CHF incl. |
|---|--|------------------------------------|---|------------------|---|---|---|
| Kosmetikspiegel | | Miroir cosmétique | | | | | |
|  |  7 611038 096274 | 45 2027 20 | weiss / mit Tesa Powerstrips <i>blanc / avec Tesa Powerstrips</i> Ø 15CM ; 8 cm | 6 |  | 20.50 | 22.08 |



Einfache Befestigung ohne zu bohren und spurlos ablösbar, dank der Tesa Powerstrips® Technologie

Fixation facile sans avoir à effectuer de perçage et facilement détachable grâce à la technologie Tesa Powerstrips®

Wandseifenspender

| EAN-Nr. <i>no EAN</i> | Artikel Nr. <i>no d'article</i> | Beschreibung <i>description</i> | VPE <i>ce</i> | VE <i>ue</i> | UVP pro Stk. <i>PVC</i> CHF excl. | UVP pro Stk. <i>PVC</i> CHF incl. |
|--------------------------|------------------------------------|------------------------------------|------------------|-----------------|---|---|
|--------------------------|------------------------------------|------------------------------------|------------------|-----------------|---|---|

Wandseifenspender Smart

Distributeur de savon Smart



45 1301 00

weiss
blanc
500 ml ; 8,5 x 10,5 x 15 cm

6



18.64

20.07



Einfache Befestigung, nach Wahl zum Kleben oder Schrauben.

Fixation facile, au choix à coller ou à visser

Wandseifenspender Compact

Distributeur de savon Compact



45 1301 02

weiss
blanc
1 x 450 ml ; 7 x 6 x 19 cm

6



18.64

20.07



Einfache Befestigung, nach Wahl zum Kleben oder Schrauben.

Fixation facile, au choix à coller ou à visser.

Wandseifenspender Compact

Distributeur de savon Compact



45 1301 04

weiss
blanc
2 x 450 ml ; 7 x 12 x 19 cm

6



33.08

35.63

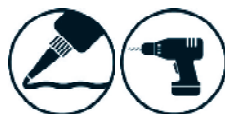

Einfache Befestigung, nach Wahl zum Kleben oder Schrauben.

Fixation facile, au choix à coller ou à visser.





Zubehör für Bad, Küche und Haushalt

*Accessoires
pour le bain, la
cuisine et
ménager*

Kapitel 4 - Inhaltsverzeichnis

Chapitre 4 - Sommaire

| | |
|---|------|
| WC-Bürstengarnituren <i>Garnitures de WC</i> | 4.4 |
| Eimer <i>Poubelles</i> | 4.17 |
| Zahngläser <i>Verres</i> | 4.21 |
| Seifenschalen <i>Porte-savonnettes</i> | 4.26 |
| Seifenspender <i>Distributeur de savon</i> | 4.34 |
| Accessoires <i>Accessoires</i> | 4.38 |
| Flugzeug Trolley <i>Trolley d'avion</i> | 4.50 |
| LED-Spiegel <i>Miroirs LED</i> | 4.52 |
| Kosmetikspiegel <i>Miroirs cosmétiques</i> | 4.55 |
| Duschablagen <i>Bacs à douche</i> | 4.60 |
| Duschregal <i>Etagère salle de bain</i> | 4.62 |
| Türgarderoben <i>Garderobes pour porte</i> | 4.63 |
| Türschilder <i>Plagues pour porte</i> | 4.65 |
| Haken <i>Crochets</i> | 4.66 |
| Steckschlüssel <i>Clé à tube</i> | 4.78 |
| Badeenten <i>Canards de bain</i> | 4.79 |
| Croll & Denecke <i>Croll & Denecke</i> | 4.86 |



ACCESSOIRES - WC-BÜRSTENGARNITUREN

ACCESSOIRES - GARNITURES DE WC

| EAN-Nr. no EAN | Artikel Nr. no d'article | Beschreibung description | VPE ce | VE ue | UVP pro Stk. PVC CHF excl. | UVP pro Stk. PVC CHF incl. |
|-------------------|-----------------------------|-----------------------------|-----------|----------|----------------------------------|----------------------------------|
|-------------------|-----------------------------|-----------------------------|-----------|----------|----------------------------------|----------------------------------|

WC-Bürstengarnitur Wandmodell

Garniture de WC modèle mural



Keramik
Céramique



45 2009 10

weiss
blanc
17 cm

1



58.71

63.23

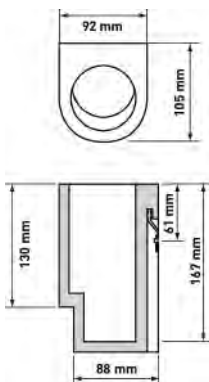

Ersatzbürste mit Stiel

Brosse de rechange complet



45 2009 94

zu Wandmodell
pour modèle mural
Ø 64 mm

1



20.04

21.58

Befestigungsset zu Wandmodell

Jeu de fixation modèle mural



45 2009 96

1



8.43

9.08

ACCESSOIRES - WC-BÜRSTENGARNITUREN

ACCESSOIRES - GARNITURES DE WC

| EAN-Nr. no EAN | Artikel Nr. no d'article | Beschreibung description | VPE ce | VE ue | UVP pro Stk. PVC CHF excl. | UVP pro Stk. PVC CHF incl. |
|-------------------|-----------------------------|-----------------------------|-----------|----------|----------------------------------|----------------------------------|
|-------------------|-----------------------------|-----------------------------|-----------|----------|----------------------------------|----------------------------------|

WC-Bürstengarnitur Wand

Garniture de WC mural



45 2012 10

INOX
11 x 11 x 42.5 cm ; 21.5 cm

12



98.79

106.39

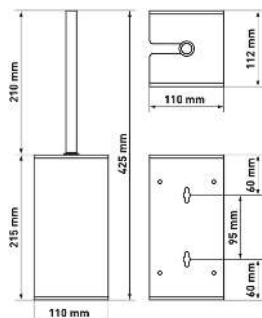

WC-Ersatzbürstenkopf

Brosse de rechange



45 9992 98

weiss
blanc
Ø 80 mm

1



8.34

8.98



Ersatztropfschale zu INOX Mod.

Égouttoir rechange mod. INOX



45 2012 93

Acryl
Acrylique
Ø 10.7 cm

100



6.48

6.98

ACCESSOIRES - WC-BÜRSTENGARNITUREN

ACCESSOIRES - GARNITURES DE WC

| | EAN-Nr. no EAN | Artikel Nr. no d'article | Beschreibung description | VPE ce | VE ue | UVP pro Stk. PVC CHF excl. | UVP pro Stk. PVC CHF incl. |
|--|-------------------|-----------------------------|-----------------------------|-----------|----------|----------------------------------|----------------------------------|
|--|-------------------|-----------------------------|-----------------------------|-----------|----------|----------------------------------|----------------------------------|

WC-Bürstengarnitur rund

Garniture de WC ronde



45 1345 97

INOX

12



74.56

80.30

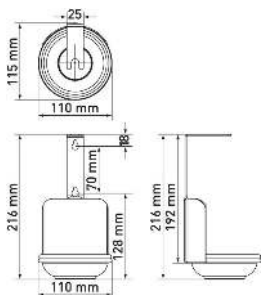

WC-Ersatzbürste

Brosse de recharge



44 0292 41

weiss, mit Randreiniger
blanc, avec brosse rebord
Ø 80 mm

10



6.90

7.43



zu
pour
45 1345 97

WC-Bürstengarnitur

Garniture de WC



45 1344 97

INOX matt 4-eckig gelocht
INOX mat perforation carré
Ø 10.5 x 38.5 cm

1



34.48

37.14

WC-Ersatzbürstenkopf

Brosse de recharge



45 9995 98

schwarz
noir
Ø 80 mm

1



8.95

9.64

ACCESSOIRES - WC-BÜRSTENGARNITUREN

ACCESSOIRES - GARNITURES DE WC

| EAN-Nr. no EAN | Artikel Nr. no d'article | Beschreibung description | VPE ce | VE ue | UVP pro Stk. PVC CHF excl. | UVP pro Stk. PVC CHF incl. |
|-------------------|-----------------------------|-----------------------------|-----------|----------|----------------------------------|----------------------------------|
|-------------------|-----------------------------|-----------------------------|-----------|----------|----------------------------------|----------------------------------|

NEW

Silikon WC-Bürste Standmodell

Silicone garniture WC

| | | | | | | |
|--|-------------------|-----------------------------|---|---|--------------|--------------|
|  7 611038 587949 | 45 2009 21 | inox matt Ø 10.5 x 49 cm | 1 |  | 17.05 | 18.37 |
|--|-------------------|-----------------------------|---|---|--------------|--------------|



- Hygienischer Bürstenkopf aus Silikon mit Antihafteffekt
- Schneller Austausch des Bürstenkopfs
- Reinigt gründlich ohne Zerkratzen
- Rückenschonend dank ergonomisch langem Stiel
- *Tête de brosse hygiénique en silicone à effet anti-adhérent*
- *Remplacement rapide du tête de brosse*
- *Nettoie minutieusement sans abîmer la céramique*
- *Nettoyage confortable grâce au long manche ergonomique*

ACCESSOIRES - WC-BÜRSTENGARNITUREN



ACCESSOIRES - GARNITURES DE WC

| EAN-Nr. no EAN | Artikel Nr. no d'article | Beschreibung description | VPE ce | VE ue | UVP pro Stk. PVC CHF excl. | UVP pro Stk. PVC CHF incl. |
|-------------------|-----------------------------|-----------------------------|-----------|----------|----------------------------------|----------------------------------|
|-------------------|-----------------------------|-----------------------------|-----------|----------|----------------------------------|----------------------------------|

NEW

Silikon WC-Bürste Wandmodell

Silicone garniture WC murale

| | | | | | | |
|---|-------------------|-----------------------------|---|---|--------------|--------------|
|  | 45 2009 20 | inox matt Ø 10.5 x 49 cm | 1 |  | 17.99 | 19.37 |
|---|-------------------|-----------------------------|---|---|--------------|--------------|

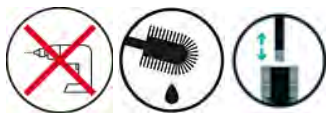



- Hygienischer Bürstenkopf aus Silikon mit Antihafteffekt
- Schneller Austausch des Bürstenkopfs
- Reinigt gründlich ohne Zerkratzen
- Rückenschonend dank ergonomisch langem Stiel
- Tête de brosse hygiénique en silicone à effet anti-adhérent
- Remplacement rapide du tête de brosse
- Nettoie minutieusement sans abîmer la céramique
- Nettoyage confortable grâce au long manche ergonomique

NEW

Ersatzsilikonbürste mit Stiel



Brosse recharge avec manche

| | | | | | | |
|---|-------------------|--|---|---|-------------|--------------|
|  | 45 2009 22 | verchromt silicone, chromé Ø 70 mm | 1 |  | 9.97 | 10.74 |
|---|-------------------|--|---|---|-------------|--------------|



WC-Ersatzbürstenkopf

Brosse recharge

| | | | | | | |
|---|-------------------|--------------------------------|---|---|-------------|-------------|
|  | 45 2009 23 | Silikon silicone Ø 70 mm | 1 |  | 7.92 | 8.53 |
|---|-------------------|--------------------------------|---|---|-------------|-------------|





ACCESSOIRES - WC-BÜRSTENGARNITUREN

ACCESSOIRES - GARNITURES DE WC

| | EAN-Nr. no EAN | Artikel Nr. no d'article | Beschreibung description | VPE ce | VE ue | UVP pro Stk. PVC CHF excl. | UVP pro Stk. PVC CHF incl. |
|--|-------------------|-----------------------------|-----------------------------|-----------|----------|----------------------------------|----------------------------------|
|--|-------------------|-----------------------------|-----------------------------|-----------|----------|----------------------------------|----------------------------------|



Stand WC-Garnitur Tracy

Set de toilette Tracy

| | | | | | | | |
|---|--|-------------------|---|---|---|---------------|---------------|
|  |  8 003341 140055 | 45 1020 97 | WC-Bürstenhalter, Papierhalter <i>Porte-papier, porte-brosse</i> Ø 25 x 25,5 x 78,5 cm | 1 |  | 148.18 | 159.59 |
|---|--|-------------------|---|---|---|---------------|---------------|



Ersatzbürstenkopf

Brosse de recharge

| | | | | | | |
|---|-------------------|--|---|--|-------------|--------------|
|  8 003341 140215 | 45 1021 98 | Modell Tracy <i>Modèle Tracy</i> Ø 65 mm | 1 |  | 9.60 | 10.34 |
|---|-------------------|--|---|--|-------------|--------------|



Ersatzbürste mit Stiel

Brosse de recharge avec manche

| | | | | | | |
|--|-------------------|--|---|---|--------------|--------------|
|  8 003341 140222 | 45 1022 98 | Modell Tracy <i>Modèle Tracy</i> Ø 65 mm | 1 |  | 37.74 | 40.65 |
|--|-------------------|--|---|---|--------------|--------------|

Ersatzglaspott

Pot de recharge

| | | | | | | |
|--|-------------------|-------------------------------------|---|---|--------------|--------------|
|  8 003341 140239 | 45 1023 98 | Modell Tracy <i>Modèle Tracy</i> | 1 |  | 21.43 | 23.09 |
|--|-------------------|-------------------------------------|---|---|--------------|--------------|

ACCESSOIRES - WC-BÜRSTENGARNITUREN

ACCESSOIRES - GARNITURES DE WC

| EAN-Nr. no EAN | Artikel Nr. no d'article | Beschreibung description | VPE ce | VE ue | UVP pro Stk. PVC CHF excl. | UVP pro Stk. PVC CHF incl. |
|-------------------|-----------------------------|-----------------------------|-----------|----------|----------------------------------|----------------------------------|
|-------------------|-----------------------------|-----------------------------|-----------|----------|----------------------------------|----------------------------------|

Stand WC-Garnitur Virginia



Set de toilette Virginia



| | | | | | | |
|--|-------------------|---|---|--|---------------|---------------|
|  8 003341 200636 | 45 1030 97 | WC-Bürstenhalter, Papierhalter <i>Porte-papier, porte-brosse</i> Ø 21 x 26 x 61 cm | 1 | | 167.75 | 180.67 |
|--|-------------------|---|---|--|---------------|---------------|



Ersatzbürstenkopf

Brosse de rechange

| | | | | | | |
|--|-------------------|--|---|---|-------------|-------------|
|  8 003341 202807 | 45 1031 98 | Modell Virginia, Florida <i>Modèle Virginia</i> | 1 |  | 8.95 | 9.64 |
|--|-------------------|--|---|---|-------------|-------------|

Ersatzbürste mit Stiel



Brosse rechange avec manche

| | | | | | | |
|--|-------------------|--|---|---|--------------|--------------|
|  8 003341 202814 | 45 1032 98 | Modell Virginia <i>Modèle Virginia</i> 60 mm | 1 |  | 33.08 | 35.63 |
|--|-------------------|--|---|---|--------------|--------------|



ACCESSOIRES - WC-BÜRSTENGARNITUREN

ACCESSOIRES - GARNITURES DE WC

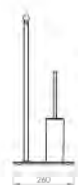
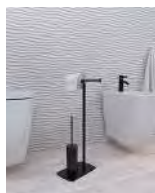

| EAN-Nr. no EAN | Artikel Nr. no d'article | Beschreibung description | VPE ce | VE ue | UVP pro Stk. PVC CHF excl. | UVP pro Stk. PVC CHF incl. |
|-------------------|-----------------------------|-----------------------------|-----------|----------|----------------------------------|----------------------------------|
|-------------------|-----------------------------|-----------------------------|-----------|----------|----------------------------------|----------------------------------|

| Stand WC-Garnitur Florida | | Set de toilette Florida | | | | |
|---|--|-------------------------|--|---|---|-----------------------------|
|  |  8 003341 112694 | 45 1041 97 | schwarz matt <i>noir</i> 15.3 x 26 x 64.4 cm | 1 |  | 215.28 231.86 |



| Handtuchständer Florida | | Porte serviette s.pied Florida | | | | |
|--|--|--------------------------------|--|---|---|-----------------------------|
|  |  8 003341 112687 | 45 1040 97 | schwarz matt <i>noir</i> 15.3 x 26 x 89.9 cm | 1 |  | 225.53 242.90 |



| WC-Bürstengarnitur | | Garniture de WC | | | | |
|---|--|-------------------|--|---|---|---------------------------|
|  |  7 611038 082635 | 46 1040 41 | weiss <i>blanc</i> 14 x 14 x 42 cm | 6 |  | 26.09 28.10 |

Kunststoff
Plastique

ACCESSOIRES - WC-BÜRSTENGARNITUREN

ACCESSOIRES - GARNITURES DE WC

| EAN-Nr. no EAN | Artikel Nr. no d'article | Beschreibung description | VPE ce | VE ue | UVP pro Stk. PVC CHF excl. | UVP pro Stk. PVC CHF incl. |
|-------------------|-----------------------------|-----------------------------|-----------|----------|----------------------------------|----------------------------------|
|-------------------|-----------------------------|-----------------------------|-----------|----------|----------------------------------|----------------------------------|

WC-Bürstengarnitur Garniture de WC



| | | | | | | |
|--|-------------------|----------------|----|---|--------------|--------------|
|  7 611038 094508 | 46 1049 41 | weiss blanc | 18 |  | 11.65 | 12.55 |
|  7 611038 094522 | 46 1049 46 | beige | 6 |  | 11.65 | 12.55 |

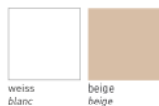

Kunststoff
Plastique

WC-Bürstengarnitur Garniture de WC





| | | | | | | |
|--|-------------------|----------------|---|---|-------------|--------------|
|  7 611038 082536 | 46 1021 41 | weiss blanc | 6 |  | 9.51 | 10.24 |
|--|-------------------|----------------|---|---|-------------|--------------|

Kunststoff
Plastique

WC-Ersatzbürste Brosse de rechange



| | | | | | | |
|--|-------------------|---------------------------|----|---|-------------|-------------|
|  7 611038 109004 | 45 0010 41 | weiss blanc Ø 80 mm | 10 |  | 4.75 | 5.12 |
|--|-------------------|---------------------------|----|---|-------------|-------------|



zu
pour
46 1021 .. / 46 1049 ..
46 1040 41

ACCESSOIRES - WC-BÜRSTENGARNITUREN

ACCESSOIRES - GARNITURES DE WC

| EAN-Nr. no EAN | Artikel Nr. no d'article | Beschreibung description | VPE ce | VE ue | UVP pro Stk. PVC CHF excl. | UVP pro Stk. PVC CHF incl. |
|-------------------|-----------------------------|-----------------------------|-----------|----------|----------------------------------|----------------------------------|
|-------------------|-----------------------------|-----------------------------|-----------|----------|----------------------------------|----------------------------------|

| WC-Bürstengarnitur mit Randreiniger | Garniture WC avec brosse de rebord |
|-------------------------------------|------------------------------------|
|-------------------------------------|------------------------------------|



46 1032 41

weiss
blanc

6



19.11

20.58



Kunststoff, zur Wandmontage
geeignet
Plastique, aussi possible
pour montage mural

| WC-Bürstengarnitur mit Randreiniger | Garniture WC avec brosse de rebord |
|-------------------------------------|------------------------------------|
|-------------------------------------|------------------------------------|



46 1051 78

marineblau
bleu marine

6



13.14

14.15



Kunststoff
Plastique























ACCESSOIRES - WC-BÜRSTENGARNITUREN

ACCESSOIRES - GARNITURES DE WC

| EAN-Nr. no EAN | Artikel Nr. no d'article | Beschreibung description | VPE ce | VE ue | UVP pro Stk. PVC CHF excl. | UVP pro Stk. PVC CHF incl. |
|-------------------|-----------------------------|-----------------------------|-----------|----------|----------------------------------|----------------------------------|
|-------------------|-----------------------------|-----------------------------|-----------|----------|----------------------------------|----------------------------------|

WC-Bürstengarnitur mit Randreiniger

Garniture WC avec brosse de rebord

| | | | | | | | |
|---|---|-------------------|--|---|---|--------------|--------------|
|  |  | 46 1082 04 | green | 6 |  | 11.28 | 12.14 |
| |  | 46 1082 08 | granit 13.5 x 14.5 x 41 cm | 6 |  | 11.— | 11.84 |
| |  | 46 1082 11 | orange 13.5 x 14.5 x 41 cm | 6 |  | 11.— | 11.84 |
| |  | 46 1082 12 | weiss transparent <i>blanc transparent</i> 13.5 x 14.5 x 41 cm | 6 |  | 11.— | 11.84 |
| |  | 46 1082 41 | weiss <i>blanc</i> 13.5 x 14.5 x 41 cm | 6 |  | 11.— | 11.84 |
| |  | 46 1082 53 | pink 13.5 x 14.5 x 41 cm | 6 |  | 11.— | 11.84 |
| |  | 46 1082 56 | blue 13.5 x 14.5 x 41 cm | 6 |  | 11.— | 11.84 |
| |  | 46 1082 58 | gray 13.5 x 14.5 x 41 cm | 6 |  | 11.— | 11.84 |
| |  | 46 1082 70 | yellow 13.5 x 14.5 x 41 cm | 6 |  | 11.— | 11.84 |
| |  | 46 1082 78 | marineblau <i>bleu marine</i> 13.5 x 14.5 x 41 cm | 6 |  | 11.— | 11.84 |
| |  | 46 1082 80 | schwarz <i>noir</i> 13.5 x 14.5 x 41 cm | 6 |  | 10.90 | 11.74 |

Kunststoff
Plastique



ACCESSOIRES - WC-BÜRSTENGARNITUREN









ACCESSOIRES - GARNITURES DE WC

| | EAN-Nr. no EAN | Artikel Nr. no d'article | Beschreibung description | VPE ce | VE ue | UVP pro Stk. PVC CHF excl. | UVP pro Stk. PVC CHF incl. |
|--|-------------------|-----------------------------|-----------------------------|-----------|----------|----------------------------------|----------------------------------|
|--|-------------------|-----------------------------|-----------------------------|-----------|----------|----------------------------------|----------------------------------|

WC-Ersatzbürste mit Randreiniger

Brosse de rechange et rebord



| | | | | | | |
|---|-------------------|--------------------------------------|---|---|-------------|-------------|
|  | 45 0012 08 | granit Ø 80 mm | 5 |  | 5.45 | 5.87 |
|  | 45 0012 41 | weiss blanc Ø 80 mm | 5 |  | 5.45 | 5.87 |
|  | 45 0012 46 | beige Ø 80 mm | 5 |  | 5.45 | 5.87 |
|  | 45 0012 78 | marineblau bleu marine Ø 80 mm | 5 |  | 5.45 | 5.87 |

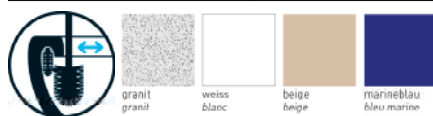



NEW

WC-Ersatzbürste mit Randreiniger

Brosse de rechange et rebord



| | | | | | | |
|--|-------------------|--|---|--|-------------|-------------|
|  | 45 0012 80 | schwarz, mit Randreiniger noir Ø 80 mm | 5 |  | 5.45 | 5.87 |
|--|-------------------|--|---|--|-------------|-------------|







100% recyceltes Polypropylen
100% polypropylène recyclé

WC-Ersatzbürste Typ LAUFEN

Brosse de rechange Type LAUFEN



| | | | | | | |
|---|-------------------|--|---|---|-------------|-------------|
|  | 44 0291 41 | weiss blanc Ø 67 mm | 1 |  | 6.76 | 7.28 |
|  | 44 0101 80 | schwarzer Bürstenkopf tête de brosse noire Ø 67 mm | 1 |  | 6.76 | 7.28 |



mit rostfreiem Edelstahldraht
avec fil de fer en acier inoxydable

ACCESSOIRES - WC-BÜRSTENGARNITUREN

ACCESSOIRES - GARNITURES DE WC

| EAN-Nr. no EAN | Artikel Nr. no d'article | Beschreibung description | VPE ce | VE ue | UVP pro Stk. PVC CHF excl. | UVP pro Stk. PVC CHF incl. |
|-------------------|-----------------------------|-----------------------------|-----------|----------|----------------------------------|----------------------------------|
|-------------------|-----------------------------|-----------------------------|-----------|----------|----------------------------------|----------------------------------|

WC-Ersatzbürste mit Stiel

Brosse de rechange



46 1185 01

verchromt
chromé
Ø 75 mm

100



21.90

23.59

WC-Ersatzbürste

Brosse de rechange



44 0292 41

weiss, mit Randreiniger
blanc, avec brosse rebord
Ø 80 mm

10



6.90

7.43



zu
pour
45 1345 97

ACCESSOIRES - Eimer

ACCESSOIRES - Poubelles

| EAN-Nr. no EAN | Artikel Nr. no d'article | Beschreibung description | VPE ce | VE ue | UVP pro Stk. PVC CHF excl. | UVP pro Stk. PVC CHF incl. |
|-------------------|-----------------------------|-----------------------------|-----------|----------|----------------------------------|----------------------------------|
|-------------------|-----------------------------|-----------------------------|-----------|----------|----------------------------------|----------------------------------|

Schwingdeckeleimer

Poubelle cosmétique





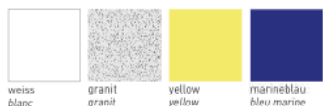









| | | | | | | |
|---|-------------------|--|---|---|--------------|--------------|
|  | 46 2730 01 | weiss <i>blanc</i> 5 l ; Ø 16.9 x 32 cm | 6 |  | 10.72 | 11.54 |
|  | 46 2730 08 | granit <i>gris</i> 5 l ; Ø 16.9 x 32 cm | 6 |  | 10.72 | 11.54 |
|  | 46 2730 70 | yellow <i>jaune</i> 5 l ; Ø 16.9 x 32 cm | 6 |  | 10.72 | 11.54 |
|  | 46 2730 78 | marineblau <i>bleu marine</i> 5 l ; Ø 16.9 x 32 cm | 6 |  | 10.72 | 11.54 |



Schwingdeckeleimer Rio

Poubelle couvercle basc. Rio





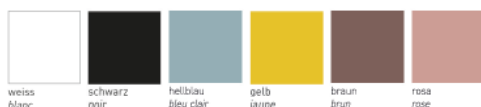

| | | | | | | |
|---|-------------------|--|---|---|--------------|--------------|
|  | 45 1988 41 | weiss <i>blanc</i> 5 l ; 21.8 x 15.2 x 28 cm | 1 |  | 16.87 | 18.17 |
|  | 45 1988 55 | schwarz <i>noir</i> 5 l ; 21.8 x 15.2 x 28 cm | 1 |  | 16.87 | 18.17 |
|  | 45 1988 56 | hellblau <i>bleu clair</i> 5 l ; 21.8 x 15.2 x 28 cm | 1 |  | 16.87 | 18.17 |
|  | 45 1988 70 | gelb <i>jaune</i> 5 l ; 21.8 x 15.2 x 28 cm | 1 |  | 16.87 | 18.17 |
|  | 45 1988 94 | braun <i>brun</i> 5 l ; 21.8 x 15.2 x 28 cm | 1 |  | 16.87 | 18.17 |
|  | 45 1988 95 | rosa <i>rose</i> 5 l ; 21.8 x 15.2 x 28 cm | 1 |  | 16.87 | 18.17 |











ACCESSOIRES - Eimer



ACCESSOIRES - Poubelles

| | EAN-Nr. no EAN | Artikel Nr. no d'article | Beschreibung description | VPE ce | VE ue | UVP pro Stk. PVC CHF excl. | UVP pro Stk. PVC CHF incl. |
|--|-------------------|-----------------------------|-----------------------------|-----------|----------|----------------------------------|----------------------------------|
|--|-------------------|-----------------------------|-----------------------------|-----------|----------|----------------------------------|----------------------------------|

| Treteimer | | Poubelle cosmétique | | | | | |
|---|--|---------------------|-------------------------------------|---|---|--------------|--------------|
|  |  7 611038 007249 | 45 1975 97 | INOX 3 l ; Ø 16.5 x 25 cm | 1 |  | 21.43 | 23.09 |
| |  8 003341 068687 | 45 1977 97 | INOX 5 l ; Ø 20 x 26.5 x 27.8 cm | 1 |  | 47.53 | 51.19 |

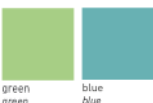
| Treteimer | | Poubelle cosmétique | | | | | |
|--|--|---------------------|---|---|---|--------------|--------------|
|  |  7 611038 177553 | 45 1984 97 | Inox, smoked copper 3 l ; Ø 16.8 x 25.8 cm | 1 |  | 23.30 | 25.09 |

| Treteimer | | Poubelle cosmétique | | | | | |
|---|--|---------------------|---|---|---|--------------|--------------|
|  |  7 611038 167523 | 45 1976 04 | Stahl - green <i>acier - green</i> 5 l ; Ø 21 x 32 cm | 1 |  | 34.48 | 37.14 |
| |  7 611038 167554 | 45 1976 56 | Stahl - blue <i>acier - blue</i> 5 l ; Ø 21 x 32 cm | 1 |  | 34.48 | 37.14 |
| |  | | | | | | |

| Treteimer Oxi | | Poubelle cosmétique Oxi | | | | | |
|---|--|-------------------------|--|---|---|--------------|--------------|
|  |  7 611038 085537 | 45 1971 97 | galvanisiert <i>galvanisé</i> 5 l ; Ø 20 x 32 cm | 1 |  | 29.82 | 32.12 |

ACCESSOIRES - Eimer

ACCESSOIRES - Poubelles

| EAN-Nr. no EAN | Artikel Nr. no d'article | Beschreibung description | VPE ce | VE ue | UVP pro Stk. PVC CHF excl. | UVP pro Stk. PVC CHF incl. |
|-------------------|-----------------------------|-----------------------------|-----------|----------|----------------------------------|----------------------------------|
|-------------------|-----------------------------|-----------------------------|-----------|----------|----------------------------------|----------------------------------|

Treteimer Romance Poubelle à pédale Romance



| | | | | | | |
|--|-------------------|--|---|--|--------------|--------------|
| | 45 1987 34 | sage matt <i>sage</i> 3 l ; Ø 16.8 x 27.5 cm | 1 | | 25.63 | 27.60 |
| | 45 1987 35 | ciel matt <i>ciel</i> 3 l ; Ø 16.8 x 27.5 cm | 1 | | 25.63 | 27.60 |
| | 45 1987 36 | powder matt <i>powder</i> 3 l ; Ø 16.8 x 27.5 cm | 1 | | 25.63 | 27.60 |
| | 45 1987 42 | weiss matt <i>blanc</i> 3 l ; Ø 16.8 x 27.5 cm | 1 | | 25.63 | 27.60 |

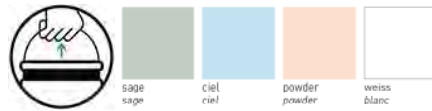

Treteimer Elegance Poubelle à pédale Elegance



| | | | | | | |
|--|-------------------|--|---|--|--------------|--------------|
| | 45 1986 97 | Inox matt, Slow Down 3 l ; Ø 19.1 x 25.9 cm | 1 | | 37.28 | 40.15 |
| | 45 1986 42 | weiss matt, Slow Down <i>blanc, Slow Down</i> 3 l ; Ø 19.1 x 25.9 cm | 1 | | 37.28 | 40.15 |
| | 45 1986 56 | blau matt, Slow Down <i>bleu, Slow Down</i> 3 l ; Ø 19.1 x 25.9 cm | 1 | | 37.28 | 40.15 |
| | 45 1986 57 | anthrazit matt, Slow Down <i>anthrazit, Slow Down</i> 3 l ; Ø 19.1 x 25.9 cm | 1 | | 37.28 | 40.15 |
| | 45 1986 70 | gelb matt, Slow Down <i>jaune, Slow Down</i> 3 l ; Ø 19.1 x 25.9 cm | 1 | | 37.28 | 40.15 |
| | 45 1986 80 | schwarz matt, Slow Down <i>noir, Slow Down</i> 3 l ; Ø 19.1 x 25.9 cm | 1 | | 37.28 | 40.15 |
| | 45 1986 93 | berry matt, Slow Down <i>berry, Slow Down</i> 3 l ; Ø 19.1 x 25.9 cm | 1 | | 37.28 | 40.15 |
| | 45 1986 94 | braun matt, Slow Down <i>brun, Slow Down</i> 3 l ; Ø 19.1 x 25.9 cm | 1 | | 37.28 | 40.15 |

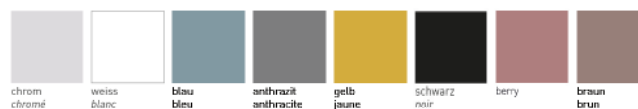

ACCESSOIRES - Eimer

ACCESSOIRES - Poubelles

| EAN-Nr. <i>no EAN</i> | Artikel Nr. <i>no d'article</i> | Beschreibung <i>description</i> | VPE <i>ce</i> | VE <i>ue</i> | UVP pro Stk. <i>PVC</i> CHF excl. | UVP pro Stk. <i>PVC</i> CHF incl. |
|--------------------------|------------------------------------|------------------------------------|------------------|-----------------|---|---|
|--------------------------|------------------------------------|------------------------------------|------------------|-----------------|---|---|

| | |
|----------------------------|---------------------------------|
| Treteimer Slow Down | Poubelle cosm. Slow Down |
|----------------------------|---------------------------------|



| | | | | | | |
|---------------------|-------------------|--|---|--|--------------|--------------|
| 7 611038 180621 | 45 1972 33 | sand 5 l ; Ø 23.5 x 30.5 cm | 1 | | 55.92 | 60.22 |
| 7 611038 180607 | 45 1972 54 | aqua 5 l ; Ø 23.5 x 30.5 cm | 1 | | 55.92 | 60.22 |
| 7 611038 180638 | 45 1972 58 | grau <i>gris</i> 5 l ; Ø 23.5 x 30.5 cm | 1 | | 55.92 | 60.22 |
| 7 611038 180614 | 45 1972 80 | schwarz <i>noir</i> 5 l ; Ø 23.5 x 30.5 cm | 1 | | 55.92 | 60.22 |



ACCESSOIRES - Zahngläser

ACCESSOIRES - Verres à dents

| | EAN-Nr. no EAN | Artikel Nr. no d'article | Beschreibung description | VPE ce | VE ue | UVP pro Stk. PVC CHF excl. | UVP pro Stk. PVC CHF incl. |
|--|-------------------|-----------------------------|-----------------------------|-----------|----------|----------------------------------|----------------------------------|
|--|-------------------|-----------------------------|-----------------------------|-----------|----------|----------------------------------|----------------------------------|

Zahnglas Olbia

Verre à dents Olbia



35 0520 94

glasklar
verre clair
Ø 62 / 53 mm ; 98 mm

6



11.74

12.65



Zahnglas

Verre à dents



35 0500 10

glasklar
verre clair
Ø 75 / 65 mm / 92 mm ; 27 CL

6



5.22

5.62



35 0500 05

rauchtopas
topaze
Ø 75 / 65 mm ; 92 mm

6



5.45

5.87



35 0550 09

weiss frosted
blanc opaque
Ø 75 / 65 mm ; 92 mm

6



13.51

14.55



ACCESSOIRES - Zahngläser

ACCESSOIRES - Verres à dents

| | EAN-Nr. no EAN | Artikel Nr. no d'article | Beschreibung description | VPE ce | VE ue | UVP pro Stk. PVC CHF excl. | UVP pro Stk. PVC CHF incl. |
|--|-------------------|-----------------------------|-----------------------------|-----------|----------|----------------------------------|----------------------------------|
|--|-------------------|-----------------------------|-----------------------------|-----------|----------|----------------------------------|----------------------------------|

Zahnglas de Luxe

Verre à dents de Luxe



Passt zur Serie CHIC von Bodenschatz
Va pour la série CHIC de Bodenschatz



7 611038 350048

35 0505 10

glasklar
verre clair
Ø 82 / 65 mm ; 88 mm

6



5.87

6.32



Zahnglas CHIC 96

Verre à dents CHIC 96



Passt zur Serie CHIC 96
Va pour la série CHIC 96



7 611038 350970

35 0510 10

glasklar
verre clair
Ø 75 / 65 mm ; 85 mm

6



9.79

10.54



Bodenschatz

Zahnglas 07/14 CHIC

Verre à dents CHIC 07/14



Passt zur Serie CHIC 07/14
Va pour la série CHIC 07/14



7 611038 140113

45 2796 75

glasklar
verre claire
Ø 75 / 60 mm ; 95 mm

6



10.90

11.74



Bodenschatz

ACCESSOIRES - Zahngläser

ACCESSOIRES - Verres à dents

| | EAN-Nr. no EAN | Artikel Nr. no d'article | Beschreibung description | VPE ce | VE ue | UVP pro Stk. PVC CHF excl. | UVP pro Stk. PVC CHF incl. |
|--|-------------------|-----------------------------|-----------------------------|-----------|----------|----------------------------------|----------------------------------|
|--|-------------------|-----------------------------|-----------------------------|-----------|----------|----------------------------------|----------------------------------|

Zahnglas universal

Verre à dents universel



35 0515 94

glasklar
verre clair
Ø 77 / 56 mm / 91 mm ; 22 CL

6



4.52

4.87



Passt zu Serien:
Va pour les séries:
Ascona, Bologna, Laguna,
Lugano, Napoli, Roma

Zahnglas

Verre à dents



46 1127 01

glasklar
verre claire
Ø 58 / 67 mm ; 96 mm

6



14.26

15.36



Passt zu Serien:
Tenero, Napoli
Va pour pour les séries:
Tenero, Napoli

Zahnglas Biasca

Verre à dents Biasca



45 6000 32

frosted
Ø 55 / 67 mm ; 96 mm

1



10.81

11.64

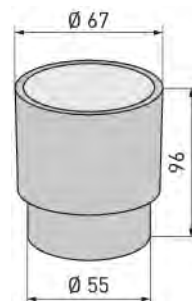

Passt zur Serie:
Biasca
Va pour la série:
Biasca



ACCESSOIRES - Zahngläser

ACCESSOIRES - Verres à dents

| EAN-Nr. no EAN | Artikel Nr. no d'article | Beschreibung description | VPE ce | VE ue | UVP pro Stk. PVC CHF excl. | UVP pro Stk. PVC CHF incl. |
|-------------------|-----------------------------|-----------------------------|-----------|----------|----------------------------------|----------------------------------|
|-------------------|-----------------------------|-----------------------------|-----------|----------|----------------------------------|----------------------------------|

Zahnglas

Verre à dents



| | | | | | | | |
|---|--|-------------------|---------------------------------|---|---|--------------|--------------|
|  |  7 611038 141417 | 45 2707 32 | frosted Ø 55 / 69 mm ; 96 mm | 1 |  | 12.30 | 13.25 |
|---|--|-------------------|---------------------------------|---|---|--------------|--------------|



Passt zur Serie:
Sofia
Va pour la série:
Sofia

Zahnglas Roma

Verre à dents Roma



| | | | | | | | |
|--|--|-------------------|--|----|---|-------------|-------------|
|  |  7 611038 081652 | 45 2704 96 | weiss frosted blanc frosted Ø 55 / 69 mm ; 96 mm | 50 |  | 8.85 | 9.54 |
|--|--|-------------------|--|----|---|-------------|-------------|



Passt zur Serie:
Roma
Va pour la série:
Roma

Ersatzbecher SMART

Gobelet à dents SMART

| | | | | | | | |
|---|--|-------------------|--|---|---|-------------|-------------|
|  |  7 611038 095857 | 45 2027 96 | weiss blanc Ø 74 / 40 mm ; 92 mm | 6 |  | 4.71 | 5.07 |
|---|--|-------------------|--|---|---|-------------|-------------|



ACCESSOIRES - Zahngläser

ACCESSOIRES - Verres à dents

| EAN-Nr. no EAN | Artikel Nr. no d'article | Beschreibung description | VPE ce | VE ue | UVP pro Stk. PVC CHF excl. | UVP pro Stk. PVC CHF incl. |
|-------------------|-----------------------------|-----------------------------|-----------|----------|----------------------------------|----------------------------------|
|-------------------|-----------------------------|-----------------------------|-----------|----------|----------------------------------|----------------------------------|

| | |
|---------------------|----------------------------|
| Ersatzbecher | Gobelet de rechange |
|---------------------|----------------------------|



45 2703 79

weiss
blanc
Ø 71 / 55 mm ; 90 mm

12



4.29

4.62



| | |
|-------------------|----------------------|
| Zahnbecher | Verre à dents |
|-------------------|----------------------|



35 0501 01

Acryl
acrylique
Ø 68 / 56 mm ; 96 mm

1



6.80

7.33



Passt zu Serien:
Va pour les séries:
Biasca, Tenero









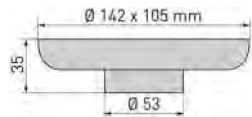

ACCESSOIRES - Seifenschalen

ACCESSOIRES - Porte-savonnettes

| EAN-Nr. no EAN | Artikel Nr. no d'article | Beschreibung description | VPE ce | VE ue | UVP pro Stk. PVC CHF excl. | UVP pro Stk. PVC CHF incl. |
|-------------------|-----------------------------|-----------------------------|-----------|----------|----------------------------------|----------------------------------|
|-------------------|-----------------------------|-----------------------------|-----------|----------|----------------------------------|----------------------------------|

| Seifenschale | Porte-savonnette | | | | | | |
|---|--|-------------------|--|---|---|--------------|--------------|
|  |  7 611038 089023 | 45 2760 30 | glasklar verre claire Ø 53 / 125 mm ; 38 x 98 mm | 6 |  | 16.68 | 17.97 |



| Seifenschale | Porte-savonnette | | | | | | |
|---|--|-------------------|--|---|---|--------------|--------------|
|  |  7 611038 350093 | 35 0600 10 | glasklar verre clair Ø 70 mm ; 125 x 45 mm | 6 |  | 12.30 | 13.25 |
| |  7 611038 350062 | 35 0600 05 | rauchtopas topaze Ø 70 mm ; 125 x 45 mm | 6 |  | 12.30 | 13.25 |
| |  7 611038 053093 | 35 0650 09 | weiss frosted blanc opaque Ø 70 mm / 130 x 40 mm | 6 |  | 19.57 | 21.08 |

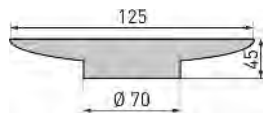
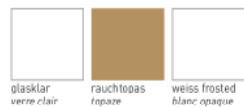

| Seifenschale CHIC 96 | Porte-savonnette CHIC 96 | | | | | | |
|---|--|-------------------|--|---|---|--------------|--------------|
|  |  7 611038 350987 | 35 0610 10 | glasklar verre clair Ø 70 mm ; 135 x 40 mm | 6 |  | 15.56 | 16.76 |

bodenschatz

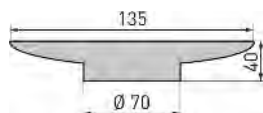

ACCESSOIRES - Seifenschalen

ACCESSOIRES - Porte-savonnettes

| EAN-Nr. no EAN | Artikel Nr. no d'article | Beschreibung description | VPE ce | VE ue | UVP pro Stk. PVC CHF excl. | UVP pro Stk. PVC CHF incl. |
|-------------------|-----------------------------|-----------------------------|-----------|----------|----------------------------------|----------------------------------|
|-------------------|-----------------------------|-----------------------------|-----------|----------|----------------------------------|----------------------------------|

Seifenschale 07/14 CHIC

Porte-savonnette CHIC 07/14



45 2796 80

glasklar
verre clair
8.4 x 14 cm ; 60 mm

6



17.15

18.47

bodenschatz

Passt zur Serie CHIC 07/14
Va pour la série CHIC 07/14

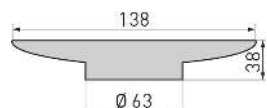

Seifenschale

Porte-savonnette



45 5941 51

glasklar
verre clair
Ø 110 / 60 mm ; 40 mm

48



8.53

9.18

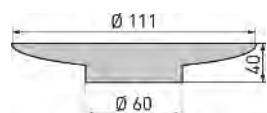

Passt zur Serie:
Tenero
Va pour la série:
Tenero

Seifenschale Biasca

Porte-savonnette Biasca



45 6000 31

frosted
Ø 56 / 111 mm ; 40 mm

1



10.81

11.64

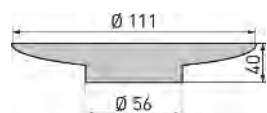

Passt zur Serie:
Biasca
Va pour la série:
Biasca

Seifenschale Sofia

Porte-savonnette Sofia



45 2707 31

frosted

1



16.87

18.17

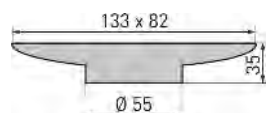

Passt zur Serie:
Sofia
Va pour la série:
Sofia

ACCESSOIRES - Seifenschalen

ACCESSOIRES - Porte-savonnettes

| | EAN-Nr. no EAN | Artikel Nr. no d'article | Beschreibung description | VPE ce | VE ue | UVP pro Stk. PVC CHF excl. | UVP pro Stk. PVC CHF incl. |
|--|-------------------|-----------------------------|-----------------------------|-----------|----------|----------------------------------|----------------------------------|
|--|-------------------|-----------------------------|-----------------------------|-----------|----------|----------------------------------|----------------------------------|

Seifenschale Roma

Porte-savonnette Roma



45 2704 94

weiss frosted
blanc frosted
Ø 55 / 80 x 135 mm ; 35 mm

60



8.85

9.54

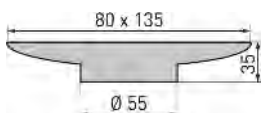

Passt zur Serie:
Roma
Va pour la série:
Roma

Seifenschale

Porte-savonnette



35 0501 02

Acryl
acrylique
Ø 60.81 mm

1



6.80

7.33

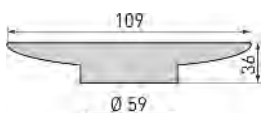

Passt zu Serien:
Biasca, Tenero
Va pour les séries:
Biasca, Tenero

Wannenseifenschale

Porte-savonnette



45 2760 35

Draht verchromt
fil chromé
160 x 88 x 39.75 mm

40



35.88

38.64

Passt zur Serie OLBIA
Va pour la série OLBIA

Wannenseifenschale

Porte-savonnette



45 2760 36

Kunststoff
Plastique
180 x 100 x 45 mm

40



12.49

13.45

Passt zur Serie OLBIA
Va pour la série OLBIA

Wannenseifenschale

Porte-savonnette



35 0700 10

transparent
4.5 x 10.5 x 18.5 cm

6



7.83

8.43



35 0700 05

rauchtopas
topaze
4.5 x 10.5 x 18.5 cm

6



7.83

8.43



transparent
transparent

rauchtopas
topaze

ACCESSOIRES - Seifenschalen



ACCESSOIRES - Porte-savonnettes

| | EAN-Nr. no EAN | Artikel Nr. no d'article | Beschreibung description | VPE ce | VE ue | UVP pro Stk. PVC CHF excl. | UVP pro Stk. PVC CHF incl. |
|--|-------------------|-----------------------------|-----------------------------|-----------|----------|----------------------------------|----------------------------------|
|--|-------------------|-----------------------------|-----------------------------|-----------|----------|----------------------------------|----------------------------------|

Wannenseifenschale CHIC 96

Porte-savonnette CHIC 96



| | | | | | | |
|--|-------------------|--|---|---|--------------|--------------|
|  7 611038 140106 | 45 2796 70 | Draht verchromt <i>fil chromé</i> 18 x 10 x 4 cm | 1 |  | 67.10 | 72.27 |
|--|-------------------|--|---|---|--------------|--------------|

bodenschatz

Seifenablage Spot

Porte-savonnette Spot



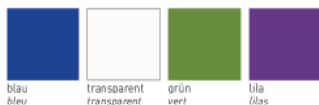

| | | | | | | |
|---|-------------------|---|----|--|-------------|-------------|
|  8 003341 174074 | 41 1528 21 | blau transparent <i>bleu transparent</i> 12.7 x 8.7 x 1.6 cm | 12 |  | 5.13 | 5.52 |
|  8 003341 174081 | 41 1528 22 | transparent 12.7 x 8.7 x 1.6 cm | 12 |  | 5.13 | 5.52 |
|  8 003341 174104 | 41 1528 28 | grün transparent <i>vert transparent</i> 12.7 x 8.7 x 1.6 cm | 12 |  | 5.13 | 5.52 |
|  8 003341 193976 | 41 1528 29 | lila transparent <i>lilas transparent</i> 12.7 x 8.7 x 1.6 cm | 12 |  | 5.13 | 5.52 |



Seifensparer

Porte-savonnette



| | | | | | | |
|--|-------------------|--------------------------------------|---|---|-------------|-------------|
|  7 611038 082666 | 41 1527 41 | weiss <i>blanc</i> 10 x 6.5 cm | 5 |  | 3.03 | 3.26 |
|--|-------------------|--------------------------------------|---|---|-------------|-------------|

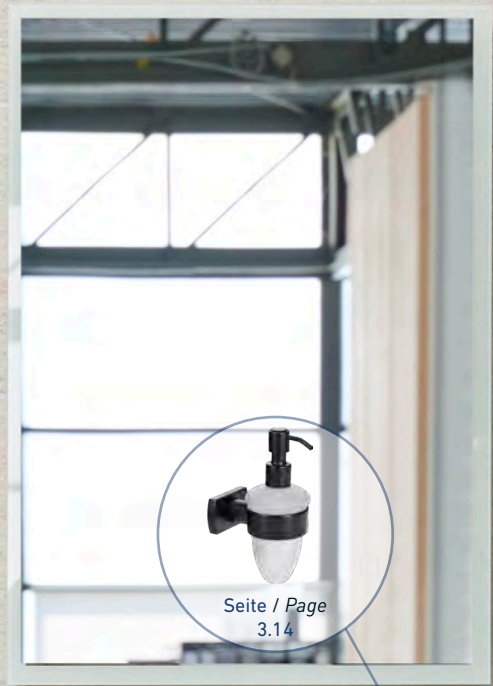

Seite / Page
3.12



Seite / Page
3.12



Seite / Page
3.14



Seite / Page
3.16



Seite / Page
5.28



Seite / Page
1.62



Seite / Page
3.13



Seite / Page
3.11

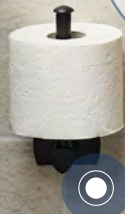

Seite / Page
3.12

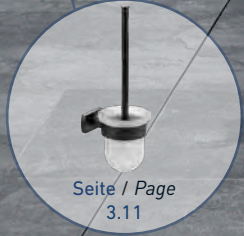

Seite / Page
3.11

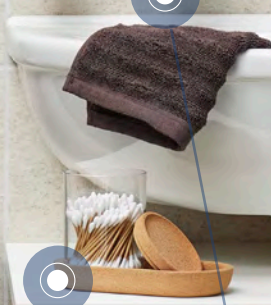



Seite / Page
1.7



Seite / Page
4.53



Seite / Page
2.55



Seite / Page
3.39



Seite / Page
1.60

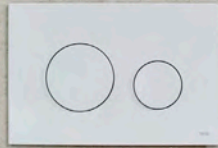

Seite / Page
5.32



Seite / Page
1.70



Seite / Page
1.64



Seite / Page
2.55



Seite / Page
1.38



Seite / Page
2.54



Seite / Page
4.19

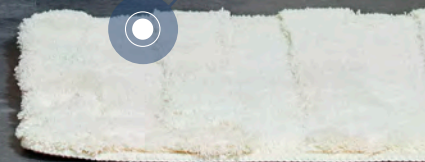

Seite / Page
1.38



Schaumseifenspender

Distributeur de savon mousse

Sparsam Économique



Extrem sparsam durch
Beimischen von Wasser
und Luft.

*Très économe grâce à
l'ajout d'eau et d'air.*

Schaumseife Savon mousse



Beim Herauspumpen der Seife wird diese mit Luft und Wasser gemischt, wodurch ein fülliger Schaum entsteht.

*Lors du pompage du
savon, ce dernier est
mélangé à de l'eau
et de l'air, occasion-
nant ainsi la création
d'une mousse on-
ctueuse.*

Seifenspender mit Sensor

Distributeur de savon avec sensor

Mit Sensor Avec sensor



Automatische und
berührungsfreie Dosie-
rung mittels Infrarot-
Sensor.

*Dosage automatique
et sans contact par
capteur infrarouge.*

Füllstandanzeige

Indicateur de niveau de remplissage



Füllanzeige zeigt auf
den ersten Blick, wie
viel Seife sich noch im
Spender befindet.

*L'indicateur de rem-
plissage montre d'un
coup d'œil la quantité
de savon restant dans le
distributeur.*

Für Seife und Desinfektionsmittel

Pour le savon et les désinfectants



Der Seifenspender
45 1301 47 kann mit
Flüssigseife oder Des-
infektionsmittel befüllt
werden.

*Le distributeur de savon
45 1301 47 peut être
rempli de savon liquide
ou de désinfectant.*

ACCESSOIRES - Seifenspender

ACCESSOIRES - Distributeurs de savon

| | EAN-Nr. no EAN | Artikel Nr. no d'article | Beschreibung description | VPE ce | VE ue | UVP pro Stk. PVC CHF excl. | UVP pro Stk. PVC CHF incl. |
|--|-------------------|-----------------------------|-----------------------------|-----------|----------|----------------------------------|----------------------------------|
|--|-------------------|-----------------------------|-----------------------------|-----------|----------|----------------------------------|----------------------------------|

Schaumseifenspender

Distributeur de savon mousse



45 1300 40

weiss matt
blanc mat
Ø 7.5 x 17 cm

1



20.04

21.58



- Extrem sparsam durch Beimischen von Wasser und Luft.
- Beim Herauspumpen der Seife wird diese mit Luft und Wasser gemischt, wodurch ein fülliger Schaum entsteht
- *Très économe grâce à l'ajout d'eau et d'air*
- *Lors du pompage du savon, ce dernier est mélangé à de l'eau et de l'air, occasionnant ainsi la création d'une mousse onctueuse*

Schaumseifenspender

Distributeur de savon mousse



45 1301 23

weiss
blanc
250 ml

1



22.37

24.09



45 1301 21

schwarz
noir
6.5 x 17 cm ; 250 ml

6



22.37

24.09



- Extrem sparsam durch Beimischen von Wasser und Luft.
- Beim Herauspumpen der Seife wird diese mit Luft und Wasser gemischt, wodurch ein fülliger Schaum entsteht
- Einfache Reinigung und rasches Nachfüllen
- *Très économe grâce à l'ajout d'eau et d'air*
- *Lors du pompage du savon, ce dernier est mélangé à de l'eau et de l'air, occasionnant ainsi la création d'une mousse onctueuse;*
- *Nettoyage simple et remplissage rapide*

ACCESSOIRES - Seifenspender ACCESSOIRES - Distributeurs de savon

| EAN-Nr. no EAN | Artikel Nr. no d'article | Beschreibung description | VPE ce | VE ue | UVP pro Stk. PVC CHF excl. | UVP pro Stk. PVC CHF incl. |
|-------------------|-----------------------------|-----------------------------|-----------|----------|----------------------------------|----------------------------------|
|-------------------|-----------------------------|-----------------------------|-----------|----------|----------------------------------|----------------------------------|

NEW

Schaumseifenspender Sensor

Distrib. savon mousse Sensor



45 1301 43

weiss
blanc
9.5 x 6.7 x 20.5 cm ; 250 ml

1



40.07

43.16



- Automatische und berührungsfreie Dosierung mittels Infrarot-Sensor
- Inhalt für 250ml Flüssigseife
- *dosage automatique et sans contact par capteur infrarouge*
- *Réservoir de 250ml de savon liquide*

NEW

Seifenspender Sensor

Distributeur savon Sensor



45 1301 47

weiss
blanc
11.6 x 7 x 21.4 cm ; 400 ml

1



51.26

55.20



- Automatische und berührungsfreie Dosierung mittels Infrarot-Sensor
- Inhalt für Flüssigseife oder Desinfektionsmittel
- *dosage automatique et sans contact par capteur infrarouge*
- *Réservoir de 400ml pour savon liquide ou désinfectant*

ACCESSOIRES - Seifenspender

ACCESSOIRES - Distributeurs de savon

| EAN-Nr. no EAN | Artikel Nr. no d'article | Beschreibung description | VPE ce | VE ue | UVP pro Stk. PVC CHF excl. | UVP pro Stk. PVC CHF incl. |
|-------------------|-----------------------------|-----------------------------|-----------|----------|----------------------------------|----------------------------------|
|-------------------|-----------------------------|-----------------------------|-----------|----------|----------------------------------|----------------------------------|

Wandseifenspender Smart

Distributeur de savon Smart



45 1301 00

weiss
blanc
500 ml ; 8,5 x 10,5 x 15 cm

6



18.64

20.07



Einfache Befestigung, nach Wahl zum Kleben oder Schrauben.

Fixation facile, au choix à coller ou à visser

Wandseifenspender Compact

Distributeur de savon Compact



45 1301 02

weiss
blanc
1 x 450 ml ; 7 x 6 x 19 cm

6



18.64

20.07



Einfache Befestigung, nach Wahl zum Kleben oder Schrauben.

Fixation facile, au choix à coller ou à visser.

Wandseifenspender Compact

Distributeur de savon Compact



45 1301 04

weiss
blanc
2 x 450 ml ; 7 x 12 x 19 cm

6



33.08

35.63

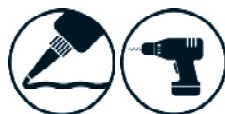

Einfache Befestigung, nach Wahl zum Kleben oder Schrauben.

Fixation facile, au choix à coller ou à visser.

ACCESSOIRES - Seifenspender

ACCESSOIRES - Distributeurs de savon

| EAN-Nr. no EAN | Artikel Nr. no d'article | Beschreibung description | VPE ce | VE ue | UVP pro Stk. PVC CHF excl. | UVP pro Stk. PVC CHF incl. |
|-------------------|-----------------------------|-----------------------------|-----------|----------|----------------------------------|----------------------------------|
|-------------------|-----------------------------|-----------------------------|-----------|----------|----------------------------------|----------------------------------|

Seifenspender mit Kst-Pumpe

Distrib. savon pompe plastique



35 0800 09

weiss frosted/chrom
blanc opaque/chromé
7.8 x 17 cm

6



27.96

30.11



Glas
Passt zur Serie CHIC von
Bodenschatz
Verre
Va pour la série CHIC de
Bodenschatz

Seifenspender mit Metallpumpe

Distrib. savon pompe métalliq.



35 0810 09

weiss frosted/chrom
blanc opaque/chromé
7.8 x 17 cm

1



39.14

42.16



35 0810 17

blau frosted/chrom
bleu opaque/chromé
7.8 x 17 cm

1



39.14

42.16

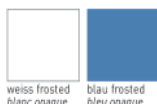

Glas
Passt zur Serie CHIC von
Bodenschatz
Verre
Va pour la série CHIC de
Bodenschatz



Ersatzpumpe

Pompe de rechange



35 0800 18

Kunststoff verchromt
plastique chromé

1



12.58

13.55



35 0800 19

Metall verchromt
métal chromé

1



28.89

31.12

ACCESSOIRES

| | EAN-Nr. no EAN | Artikel Nr. no d'article | Beschreibung description | VPE ce | VE ue | UVP pro Stk. PVC CHF excl. | UVP pro Stk. PVC CHF incl. |
|--|-------------------|-----------------------------|-----------------------------|-----------|----------|----------------------------------|----------------------------------|
|--|-------------------|-----------------------------|-----------------------------|-----------|----------|----------------------------------|----------------------------------|

Duschmittelhalter Drip

Support produit douche Drip



45 2028 10

weiss / 2 Stück
blanc / 2 pièces

24



8.25

8.88



Handwaschbürste

Brosse à mains



42 0946 41

weiss
blanc
3 x 5 x 10.5 cm

3



5.13

5.52



40 0946 78

marineblau
bleu marine
3 x 5 x 10.5 cm

3



5.13

5.52



40 0946 79

anthrazit
3 x 5 x 10.5 cm

3



5.13

5.52



40 0946 80

taupe
3 x 5 x 10.5 cm

3



5.13

5.52



Duschwischer

Raclette de douche



42 0228 97

verchromt
chromé
24.5 x 2.5 x 16.4 cm

1



45.67

49.18



ACCESSOIRES

| EAN-Nr. no EAN | Artikel Nr. no d'article | Beschreibung description | VPE ce | VE ue | UVP pro Stk. PVC CHF excl. | UVP pro Stk. PVC CHF incl. |
|-------------------|-----------------------------|-----------------------------|-----------|----------|----------------------------------|----------------------------------|
|-------------------|-----------------------------|-----------------------------|-----------|----------|----------------------------------|----------------------------------|

Duschwischer Silikon Scala

Raclette de douche Scala



| | | | | | | |
|--|-------------------|---|---|--|--------------|--------------|
|  7 611038 181314 | 42 0227 98 | anthrazit, inkl. Halterung <i>anthracite, avec support</i> 24.3 x 17.3 cm | 1 |  1 | 34.02 | 36.64 |
|--|-------------------|---|---|--|--------------|--------------|

Duschwischer Vio

Raclette de douche Vio



| | | | | | | |
|---|-------------------|--|---|---|--------------|--------------|
|  7 611038 183943 | 42 0224 98 | aqua 20.0 x 16.5 cm | 1 |  1 | 26.56 | 28.61 |
|  7 611038 183844 | 42 0225 98 | hellblau <i>ciel claire</i> 20.0 x 16.5 cm | 1 |  1 | 26.56 | 28.61 |
|  7 611038 183837 | 42 0226 98 | weiss <i>blanc</i> 20.0 x 16.5 cm | 1 |  1 | 26.56 | 28.61 |



Duschwischer SMART

Nett. cabines douche SMART







| | | | | | | |
|--|-------------------|--|---|--|--------------|--------------|
|  7 611038 096182 | 45 2027 13 | weiss / mit Tesa Powerstrips <i>blanc / avec Tesa Powerstrips</i> 18 x 5 x 28 cm | 3 |  1 | 11.46 | 12.35 |
|--|-------------------|--|---|--|--------------|--------------|



Einfache Befestigung ohne zu bohren und spurlos ablösbar, dank der Tesa Powerstrips® Technologie

Fixation facile sans avoir à effectuer de perçage et facilement détachable grâce à la technologie Tesa Powerstrips®

ACCESSOIRES

| | EAN-Nr. no EAN | Artikel Nr. no d'article | Beschreibung description | VPE ce | VE ue | UVP pro Stk. PVC CHF excl. | UVP pro Stk. PVC CHF incl. |
|---|--|-----------------------------------|--|-----------|---|----------------------------------|----------------------------------|
| Hygiene-Bag Spender 2-teilig | | Distributeur "Hygiene-Bag" | | | | | |
|  |  4 024009 002205 | 37 0326 01 | verchromt chromé 13.5 x 9.5 x 2.7 cm | 1 |  | 35.88 | 38.64 |
|  | | | | | | | |
| Hygiene-Bag Ersatzbeutel | | Sachets de rechange | | | | | |
| |  7 611038 370220 | 37 0306 00 | Schachtel à 30 Beutel Boîte avec 30 sachets | 25 |  | 10.81 | 11.64 |
| Hocker | | Tabouret | | | | | |
|  |  7 611038 085148 | 41 2898 41 | weiss blanc 42.5 x 37 x 43 cm | 15 |  | 66.17 | 71.26 |
| Reserverollenhalter | | Réserve pour papier WC | | | | | |
|  |  7 611038 048808 | 45 1996 97 | verchromt chromé 15 x 40 cm | 1 |  | 36.35 | 39.14 |
| rostfrei inoxydable | | | | | | | |



ACCESSOIRES

| | EAN-Nr. no EAN | Artikel Nr. no d'article | Beschreibung description | VPE ce | VE ue | UVP pro Stk. PVC CHF excl. | UVP pro Stk. PVC CHF incl. |
|--|-------------------|-----------------------------|-----------------------------|-----------|----------|----------------------------------|----------------------------------|
|--|-------------------|-----------------------------|-----------------------------|-----------|----------|----------------------------------|----------------------------------|

Kosmetikeimer m. Schwingdeckel

Poubelle cosmétique





| | | | | | | |
|---|------------|---|---|---|-------|-------|
|  | 45 1221 21 | inox matt couvercle basculant, inox mat 1.25 L ; Ø 12 x 16.5 cm | 1 |  | 18.08 | 19.47 |
|---|------------|---|---|---|-------|-------|

Kosmetikeimer

Poubelle cosmétique



| | | | | | | |
|---|------------|---------------------------------------|---|---|-------|-------|
|  | 45 1221 22 | inox matt inox mat Ø 12 x 14 cm | 1 |  | 18.08 | 19.47 |
|---|------------|---------------------------------------|---|---|-------|-------|

Feuchttuchbox Trend Inox

Boîte à serviettes Trend Inox

| | | | | | | |
|--|------------|---|----|---|-------|-------|
|  | 45 1633 97 | INOX matt INOX mat 14.5 x 12 x 6.8 cm | 36 |  | 45.20 | 48.68 |
|--|------------|---|----|---|-------|-------|

Papiertuchspender Trend Inox



Distrib. serviettes Trend Inox

| | | | | | | |
|---|------------|---|----|---|-------|-------|
|  | 45 1622 97 | INOX matt INOX mat 26 x 13 x 9 cm | 12 |  | 48.46 | 52.19 |
|---|------------|---|----|---|-------|-------|

Papiertuchspender

Distributeur serviettes Bambou





| | | | | | | |
|---|------------|------------------------------------|---|---|-------|-------|
|  | 45 1221 20 | weiss blanc 26 x 13 x 7.2 cm | 1 |  | 15.94 | 17.16 |
|---|------------|------------------------------------|---|---|-------|-------|

NEW

Papiertuchspender Bambou

Distrib. de serviettes Bambou



| | | | | | | |
|---|------------|------------------------------------|---|---|-------|-------|
|  | 45 1221 35 | Bambus bambou 25 x 13 x 9 cm | 1 |  | 17.61 | 18.97 |
|---|------------|------------------------------------|---|---|-------|-------|



100% Bambus
100% bambou

ACCESSOIRES

| | EAN-Nr. no EAN | Artikel Nr. no d'article | Beschreibung description | VPE ce | VE ue | UVP pro Stk. PVC CHF excl. | UVP pro Stk. PVC CHF incl. |
|--|-------------------|-----------------------------|-----------------------------|-----------|----------|----------------------------------|----------------------------------|
|--|-------------------|-----------------------------|-----------------------------|-----------|----------|----------------------------------|----------------------------------|

Badewannenablage

Plateau de baignoire



45 1221 23

ausziehbar, Bambus
extensible, bambou
75-109 x 23.4 x 4.5 cm

1



54.99

59.22



Badewannenablage

Plateau de baignoire



45 1221 24

ausziehbar, verchromt
extensible, chromé
63-77.5 x 15.5 x 5 cm

1



16.22

17.46



Föhnhalter

Support sèche-cheveux



45 2134 98

verchromt
chromé
11 x 15.5 x 15 cm

4



55.92

60.22





Bis 10 kg belastbar.
Résiste jusqu'à 10 kg.

ACCESSOIRES

| | EAN-Nr. <i>no EAN</i> | Artikel Nr. <i>no d'article</i> | Beschreibung <i>description</i> | VPE <i>ce</i> | VE <i>ue</i> | UVP pro Stk. <i>PVC</i> CHF excl. | UVP pro Stk. <i>PVC</i> CHF incl. |
|--|--------------------------|------------------------------------|------------------------------------|------------------|-----------------|---|---|
|--|--------------------------|------------------------------------|------------------------------------|------------------|-----------------|---|---|

Föhnhalter mit Saugnapf













Sup. sèche-cheveux a. ventouse

| | | | | | | | |
|---|--|-------------------|---|---|--|--------------|--------------|
|  |  8 003341 193563 | 45 2133 98 | verchromt <i>chromé</i> 10.7 x 12 x 22 cm | 4 |  1 | 25.16 | 27.10 |
|---|--|-------------------|---|---|--|--------------|--------------|









Bis 5 kg belastbar.
Résiste jusqu'à 5 kg.

ACCESSOIRES



| | EAN-Nr. no EAN | Artikel Nr. no d'article | Beschreibung description | VPE ce | VE ue | UVP pro Stk. PVC CHF excl. | UVP pro Stk. PVC CHF incl. |
|---|---|--------------------------------------|--|-----------|---|----------------------------------|----------------------------------|
| Zahnbürstenhalter Basic | | Porte-brosse à dents Basic | | | | | |
|  |  | 45 2350 20 | aqua & rose | 12 |  | 8.53 | 9.18 |
| Zahnbürstenhalter Fun animal | | Porte-brosse dents Fun animal | | | | | |
|  |  | 45 2350 70 | Giraffe <i>Girafe</i> 4.1 x 4.0 x 5.4 cm | 12 |  | 8.53 | 9.18 |
| Zahnbürstenhalter Fun animal | | Porte-brosse dents Fun animal | | | | | |
|  |  | 45 2350 71 | Elefant <i>Éléphant</i> 4.1 x 4.0 x 5.4 cm | 12 |  | 8.53 | 9.18 |
| Zahnbürstenhalter Fun animal | | Porte-brosse dents Fun animal | | | | | |
|  |  | 45 2350 72 | Löwe <i>Lion</i> 4.1 x 4.0 x 5.4 cm | 12 |  | 8.53 | 9.18 |
| Zahnbürstenhalter Fun animal | | Porte-brosse dents Fun animal | | | | | |
|  |  | 45 2350 73 | Panda 4.1 x 4.0 x 5.4 cm | 12 |  | 8.53 | 9.18 |

ACCESSOIRES

| | EAN-Nr. <i>no EAN</i> | Artikel Nr. <i>no d'article</i> | Beschreibung <i>description</i> | VPE <i>ce</i> | VE <i>ue</i> | UVP pro Stk. <i>PVC</i> CHF excl. | UVP pro Stk. <i>PVC</i> CHF incl. |
|---|--|------------------------------------|------------------------------------|------------------|---|---|---|
| Rasiererhalter Mizo | | Porte-rasoir Mizo | | | | | |
|  |  9 555038 903423 | 45 2360 00 | blau <i>bleu</i> | 12 |  | 11.09 | 11.94 |

| | | | | | | | |
|---|--|--------------------------|--|---|---|-------------|-------------|
| Rasiererhalter | | Support de rasoir | | | | | |
|  |  7 611038 162450 | 35 7018 01 | weiss <i>blanc</i> 30 x 25 x 10 x 3 mm | 5 |  | 6.66 | 7.18 |

NEW

| | | | | | | | |
|---|--|-----------------------------------|---|---|---|--------------|--------------|
| Kosmetikflaschen 3er Set | | Set de Flacons cosmétiques | | | | | |
|  |  7 611038 692667 | 45 1221 32 | assortiert grau, aqua, mint <i>assortis, gris, aqua, mint</i> Ø 4.5 x 8 cm, 59 ml ; 3STK / 3PCS | 1 |  | 15.80 | 17.01 |

100% Silikon
100% Silicone



Geeignet für Shampoo, Duschmittel, Gels, Crème, Desinfektionsmittel
Convient pour les produits de douche, les gels, les crèmes, les désinfectants



Handgepäcktauglich, ideal für Reisen
Peut être emporté en bagage à main - idéal pour les voyages



Auslaufsicher
Anti-fuite



Wiederbefüllbar
Rechargeable

ACCESSOIRES

| EAN-Nr. no EAN | Artikel Nr. no d'article | Beschreibung description | VPE ce | VE ue | UVP pro Stk. PVC CHF excl. | UVP pro Stk. PVC CHF incl. |
|-------------------|-----------------------------|-----------------------------|-----------|----------|----------------------------------|----------------------------------|
|-------------------|-----------------------------|-----------------------------|-----------|----------|----------------------------------|----------------------------------|

Wasserhahnverlängerung Kids

Rallonge de robinet Kids



| | | | | | | |
|---|-------------------|--|---|---|-------------|-------------|
|  | 45 2360 10 | Dolphie, gelb/blau <i>Dolphie, jaune/bleu</i> | 1 |  | 5.87 | 6.32 |
|  | 45 2360 11 | Dolphie, gelb/pink <i>Dolphie, jaune/pink</i> | 1 |  | 5.87 | 6.32 |



Wasserhahnverlängerung Kids

Rallonge de robinet Kids



| | | | | | | |
|--|-------------------|--|---|--|-------------|-------------|
|  | 45 2360 13 | Bastie, gelb/pink <i>Bastie, jaune/pink</i> | 1 |  | 5.87 | 6.32 |
|  | 45 2360 12 | Bastie, gelb/blau <i>Bastie, jaune/bleu</i> | 1 |  | 5.87 | 6.32 |





Seite / Page
1.15



Seite / Page
4.53



Seite / Page
2.55



Seite / Page
3.39



Seite / Page
1.60

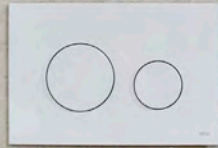

Seite / Page
5.52



Seite / Page
1.70



Seite / Page
1.64



Seite / Page
1.38



Seite / Page
2.54



Seite / Page
4.19

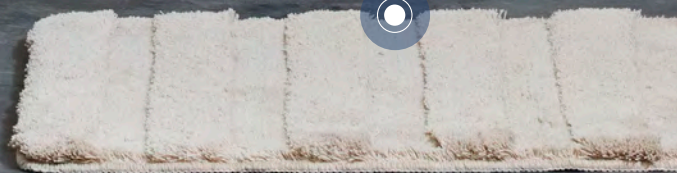
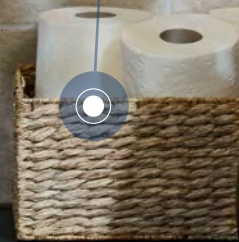



Flugzeug Trolley

Chariot avion

Vielseitig einsetzbar

Polyvalent



Als Aufbewahrungslösung für Bad, Küche oder Wohnzimmer, als Minibar oder Home-Office.

Utilisable de multiples façons, comme solution de rangement pour la salle de bains, la cuisine ou la chambre, comme mini-bar ou bureau à domicile.

Robustes Material

Matériau robuste

Echte Airline Ausführung aus robustem Aluprofil, rundum isoliert.

Design Airline en profilé alu grande robustesse et isolation envelop-pante.

Zubehör

Accessoires



Inklusive zwei Kunststoffschubladen, drei Kunststoffablaren und einem kleinen Fach ganz oben passend für Dokumente oder Ähnliches.

Comprend deux tiroirs en plastique, trois étagères en plastique et un petit compartiment tout en haut pour les documents ou autres.

Doppelrollen mit Feststellbremse

Roulettes doubles freinées



Swissair Logo

Logo de Swissair



Zwei verschiedene Varianten erhältlich: mit oder ohne Original Swissair Logo.

Deux variantes disponibles: avec ou sans le logo original de Swissair.

ACCESSOIRES - Trolley









| EAN-Nr. no EAN | Artikel Nr. no d'article | Beschreibung description | VPE ce | VE ue | UVP pro Stk. PVC CHF excl. | UVP pro Stk. PVC CHF incl. |
|-------------------|-----------------------------|-----------------------------|-----------|----------|----------------------------------|----------------------------------|
|-------------------|-----------------------------|-----------------------------|-----------|----------|----------------------------------|----------------------------------|

NEW

Flugzeug Trolley

Trolley d'avion



| | | | | | | |
|--|-------------------|--|---|---|----------------|----------------|
|  7 611038 179953 | 46 0000 97 | weiss blanc 30.15 x 40.5 x 103 cm | 1 |  | 945.93 | 1018.77 |
|  7 611038 388720 | 46 0000 98 | anthrazit anthracite 30.15 x 40.5 x 103 cm | 1 |  | 945.93 | 1018.77 |
|  7 611038 177614 | 46 0001 97 | weiss mit Swissair-Logo blanc avec logo Swissair 30.15 x 40.5 x 103 cm | 1 |  | 1027.94 | 1107.10 |
|  7 611038 388737 | 46 0001 98 | anthrazit, Swissair-Logo anthracite, logo Swissair 30.15 x 40.5 x 103 cm | 1 |  | 1027.94 | 1107.10 |



- Echte Airline Ausführung aus robustem Aluprofil, rundum isoliert
- Doppelrollen mit Feststellbremsen
- Design Airline en profilé alu grande robustesse et isolation enveloppante
- Roulettes doubles freinées

Inklusive 2 Kunststoffschubladen und 3 Kunststoffablaren
2 tiroirs et 3 étagères plastique compris à la livraison



Als Aufbewahrungslösung vielseitig einsetzbar
Utilisable de multiples façons.

Dekoration nicht im Verpackungsumfang inbegriffen!
La décoration n'est pas comprise dans l'emballage!

Schublade zu Flugzeug Trolley

Tiroir pour trolley d'avion



| | | | | | | |
|--|-------------------|------------------------------------|---|---|--------------|--------------|
|  7 611038 182335 | 46 0000 96 | transparent 38 x 27.3 x 10.6 cm | 1 |  | 25.63 | 27.60 |
|--|-------------------|------------------------------------|---|---|--------------|--------------|

ACCESSOIRES - Trolley

| | EAN-Nr. <i>no EAN</i> | Artikel Nr. <i>no d'article</i> | Beschreibung <i>description</i> | VPE <i>ce</i> | VE <i>ue</i> | UVP pro Stk. <i>PVC</i> CHF excl. | UVP pro Stk. <i>PVC</i> CHF incl. |
|--|--------------------------|------------------------------------|------------------------------------|------------------|-----------------|---|---|
|--|--------------------------|------------------------------------|------------------------------------|------------------|-----------------|---|---|

Tablar zu Flugzeug Trolley

Étagère pour trolley d'avion



46 0000 94

grau
gris
38 x 27.3 x 1.4 cm

1



17.61

18.97

ACCESSOIRES - LED Spiegel

ACCESSOIRES - LED Miroirs

| EAN-Nr. <i>no EAN</i> | Artikel Nr. <i>no d'article</i> | Beschreibung <i>description</i> | VPE <i>ce</i> | VE <i>ue</i> | UVP pro Stk. <i>PVC</i> CHF excl. | UVP pro Stk. <i>PVC</i> CHF incl. |
|--------------------------|------------------------------------|------------------------------------|------------------|-----------------|---|---|
|--------------------------|------------------------------------|------------------------------------|------------------|-----------------|---|---|

LED Lichtspiegel Porto

LED Miroir Porto



7 611038 182250

44 0261 94

Alu
aluminium
60 x 80 x 3.3 cm

1



389.56

419.55

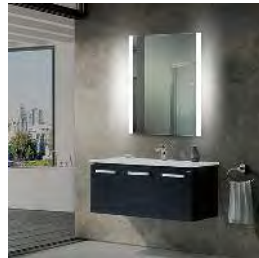

- Robuster Alurahmen, 5 mm Spiegelglas
- Zweiseitig gefrosteter Rand 20 mm
- Mit LED beleuchtetem Acrylrahmen in zwei Farbtönen 4000/6000K
- Montage wahlweise vertikal oder horizontal
- Spiegel läuft nicht an dank Antibeschlag-Technik
- Berührungssensor zum Ein- und Ausschalten
- *Cadre robuste en aluminium, glace miroir de 5 mm*
- *Bord dépoli de 20 mm sur deux côtés*
- *Cadre acrylique bicolore éclairé par des LED 4000/6000 K*
- *Pose verticale ou horizontale au choix*
- *Le miroir reste toujours net grâce à un traitement anti-buée*
- *Capteur tactile pour la mise en marche et l'arrêt*

ACCESSOIRES - LED Spiegel

ACCESSOIRES - LED Miroirs

| EAN-Nr. no EAN | Artikel Nr. no d'article | Beschreibung description | VPE ce | VE ue | UVP pro Stk. PVC CHF excl. | UVP pro Stk. PVC CHF incl. |
|-------------------|-----------------------------|-----------------------------|-----------|----------|----------------------------------|----------------------------------|
|-------------------|-----------------------------|-----------------------------|-----------|----------|----------------------------------|----------------------------------|

LED Lichtspiegel FARO

LED Miroir Faro



- Robuster Alurahmen, 5 mm Spiegelglas
- Gefrosteter Rand 20 mm
- Mit LED beleuchtetem Acrylrahmen in zwei Farbtönen 4000/6000K
- Montage wahlweise vertikal oder horizontal
- Spiegel läuft nicht an dank Antibeschlag-Technik
- Berührungssensor zum Ein- und Ausschalten
- Cadre robuste en aluminium, glace miroir de 5 mm
- Bord dépoli de 20 mm
- Cadre acrylique bicolore éclairé par des LED 4000/6000 K
- Pose verticale ou horizontale au choix
- Le miroir reste toujours net grâce à un traitement anti-buée
- Capteur tactile pour la mise en marche et l'arrêt

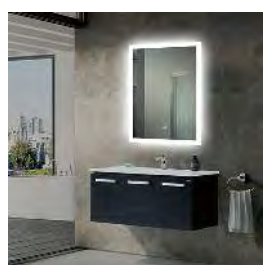

| | | | | | | |
|--|-------------------|---------------------------------------|---|--|---------------|---------------|
| | 44 0262 94 | Alu aluminium 50 x 70 x 3.3 cm | 1 | | 416.58 | 448.66 |
| | 44 0263 94 | Alu aluminium 100 x 70 x 3.3 cm | 1 | | 617.89 | 665.46 |
| | 44 0265 94 | Alu aluminium 60 x 70 x 3.3 cm | 1 | | 468.77 | 504.87 |
| | 44 0266 94 | Alu aluminium 90 x 70 x 3.3 cm | 1 | | 580.61 | 625.31 |
| | 44 0267 94 | Alu aluminium 120 x 70 x 3.3 cm | 1 | | 698.97 | 752.79 |



ACCESSOIRES - LED Spiegel

ACCESSOIRES - LED Miroirs

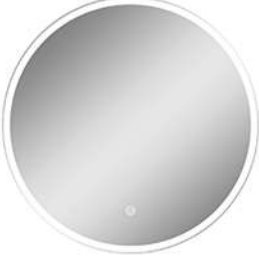
| EAN-Nr. <i>no EAN</i> | Artikel Nr. <i>no d'article</i> | Beschreibung <i>description</i> | VPE <i>ce</i> | VE <i>ue</i> | UVP pro Stk. <i>PVC</i> CHF excl. | UVP pro Stk. <i>PVC</i> CHF incl. |
|--------------------------|------------------------------------|------------------------------------|------------------|-----------------|---|---|
|--------------------------|------------------------------------|------------------------------------|------------------|-----------------|---|---|

| LED Lichtspiegel Lures | | LED Miroir Lures | | | | |
|---|--|-------------------|-----------------------------------|---|---|-----------------------------|
|  |  7 611038 182281 | 44 0264 94 | Alu aluminium Ø 60 x 3.3 cm | 1 |  | 399.81 430.59 |



- Robuster Alurahmen, 5 mm Spiegelglas
- Gefrosteter Rand 20 mm
- Mit LED beleuchtetem Acrylrahmen in zwei Farbtönen 4000/6000K
- Spiegel läuft nicht an dank Antibeslag-Technik
- Berührungssensor zum Ein- und Ausschalten
- *Cadre robuste en aluminium, glace miroir de 5 mm*
- *Bord dépoli de 20 mm*
- *Cadre acrylique bicolore éclairé par des LED 4000/6000 K*
- *Le miroir reste toujours net grâce à un traitement anti-buée*
- *Capteur tactile pour la mise en marche et l'arrêt*







ACCESSOIRES - Spiegel

ACCESSOIRES - Miroirs

| EAN-Nr. no EAN | Artikel Nr. no d'article | Beschreibung description | VPE ce | VE ue | UVP pro Stk. PVC CHF excl. | UVP pro Stk. PVC CHF incl. |
|-------------------|-----------------------------|-----------------------------|-----------|----------|----------------------------------|----------------------------------|
|-------------------|-----------------------------|-----------------------------|-----------|----------|----------------------------------|----------------------------------|

LED Kosmetik-Wandspiegel Nelas





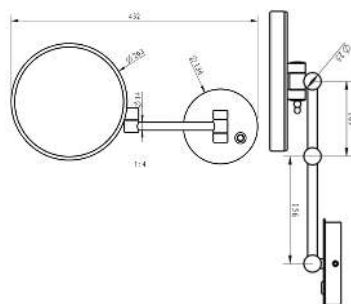

Miroir murale cosm. LED Nelas

| | | | | | | | |
|---|---|-------------------|---|---|---|---------------|---------------|
|  <ul style="list-style-type: none"> - für Wandmontage mit Direktanschluss - mit frei drehbarem Spiegelarm - Vergrößerungsfaktor: 3x - Farbton: 5500 K / weiss - Schutzklasse: IP 44 - Netzanschluss: 230V / 50-60Hz - pour montage mural avec raccordement mural - avec bras articulé - Facteur d'agrandissement: 3x - Température de couleur: 5500 K / blanc - Indice de protection: IP 44 - Tension électrique: 230V / 50-60Hz |  | 44 0301 01 | Messing verchromt, ohne Kabel <i>laiton chromé, sans cable</i> Ø 20 cm ; 3X | 1 |  | 435.22 | 468.73 |
| |  | 44 0301 02 | weiss, ohne Kabel <i>blanc, sans cable</i> Ø 20 cm ; 3X | 1 |  | 455.73 | 490.82 |
| |  | 44 0301 03 | schwarz, Wandmontage <i>noir, sans cable</i> Ø 20 cm ; 3X | 1 |  | 455.73 | 490.82 |



LED Kosmetik-Wandspiegel Nelas

Miroir murale cosm. LED Nelas

| | | | | | | | |
|---|---|-------------------|--|---|---|---------------|---------------|
|  <ul style="list-style-type: none"> - für Wandmontage mit Kabel - mit frei drehbarem Spiegelarm - Vergrößerungsfaktor: 3x - Farbton: 5500 K / weiss - Schutzklasse: IP 44 - Netzanschluss: 230V / 50-60Hz - pour montage mural avec câble en spirale - avec bras articulé - Facteur d'agrandissement: 3x - Température de couleur: 5500 K / blanc - Indice de protection: IP 44 - Tension électrique: 230V / 50-60Hz |  | 44 0301 04 | Messing verchromt, mit Kabel <i>laiton chromé, avec cable</i> Ø 20 cm ; 3X | 1 |  | 455.73 | 490.82 |
| |  | 44 0301 05 | weiss, mit Kabel <i>white, avec cable</i> Ø 20 cm ; 3X | 1 |  | 484.62 | 521.93 |
| |  | 44 0301 06 | schwarz, mit Kabel <i>noir, avec cable</i> Ø 20 cm ; 3X | 1 |  | 484.62 | 521.93 |

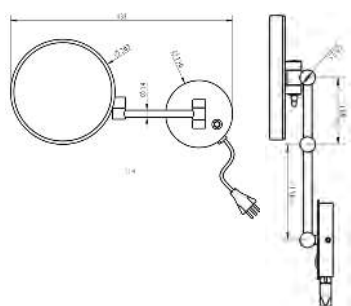

ACCESSOIRES - Spiegel

ACCESSOIRES - Miroirs

| EAN-Nr. no EAN | Artikel Nr. no d'article | Beschreibung description | VPE ce | VE ue | UVP pro Stk. PVC CHF excl. | UVP pro Stk. PVC CHF incl. |
|-------------------|-----------------------------|-----------------------------|-----------|----------|----------------------------------|----------------------------------|
|-------------------|-----------------------------|-----------------------------|-----------|----------|----------------------------------|----------------------------------|

LED Kosmetik-Wandspiegel Ferro

Miroir murale cosm. LED Ferro

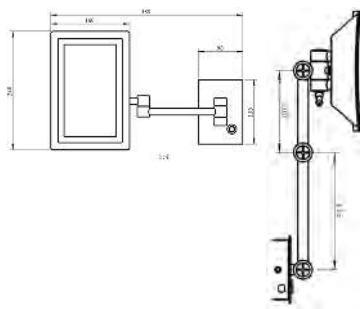

| | | | | | | | |
|---|---|-------------------|--|---|---|---------------|---------------|
|  |  | 44 0302 01 | Messing verchromt, ohne Kabel <i>laiton chromé, sans cable</i> 16 x 24 cm ; 3X | 1 |  | 435.22 | 468.73 |
|---|---|-------------------|--|---|---|---------------|---------------|

- für Wandmontage mit Direktanschluss
- mit frei drehbarem Spiegelarm
- Vergrößerungsfaktor: 3x
- Farbton: 5500 K / weiss
- Schutzklasse: IP 44
- Netzanschluss: 230V / 50-60Hz
- pour montage mural avec raccordement mural
- avec bras articulé
- Facteur d'agrandissement: 3x
- Température de couleur: 5500 K / blanc
- Indice de protection: IP 44
- Tension électrique: 230V / 50-60Hz



LED Kosmetik-Wandspiegel Ferro

Miroir murale cosm. LED Ferro

| | | | | | | | |
|---|---|-------------------|---|---|---|---------------|---------------|
|  |  | 44 0302 04 | Messing verchromt, mit Kabel <i>laiton chromé, avec cable</i> 16 x 24 cm ; 3X | 1 |  | 445.47 | 479.78 |
|---|---|-------------------|---|---|---|---------------|---------------|

- für Wandmontage mit Kabel
- mit frei drehbarem Spiegelarm
- Vergrößerungsfaktor: 3x
- Farbton: 5500 K / weiss
- Schutzklasse: IP 44
- Netzanschluss: 230V / 50-60Hz
- pour montage mural avec câble en spirale
- avec bras articulé
- Facteur d'agrandissement: 5x
- Température de couleur: 5500 K / blanc
- Indice de protection: IP 44
- Tension électrique: 230V / 50-60Hz

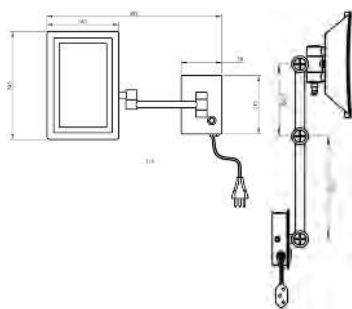

ACCESSOIRES - Spiegel







ACCESSOIRES - Miroirs

| EAN-Nr. no EAN | Artikel Nr. no d'article | Beschreibung description | VPE ce | VE ue | UVP pro Stk. PVC CHF excl. | UVP pro Stk. PVC CHF incl. |
|-------------------|-----------------------------|-----------------------------|-----------|----------|----------------------------------|----------------------------------|
|-------------------|-----------------------------|-----------------------------|-----------|----------|----------------------------------|----------------------------------|

LED Kosmetikspiegel Maia

Miroir cosmétique LED Maia



| | | | | | | |
|---|-------------------|--|---|---|---------------|---------------|
|  | 44 0303 01 | Messing verchromt, mit Kabel <i>laiton chromé, avec cable</i> Ø 20 cm ; 3X | 1 |  | 361.60 | 389.44 |
|  | 44 0303 02 | weiss, mit Kabel <i>blanc, avec cable</i> Ø 20 cm ; 3X | 1 |  | 383.03 | 412.53 |
|  | 44 0303 03 | schwarz, mit Kabel <i>noir, avec cable</i> Ø 20 cm ; 3X | 1 |  | 383.03 | 412.53 |

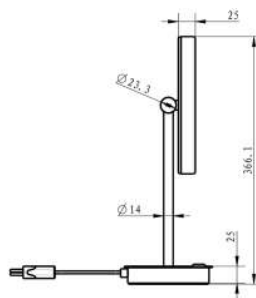
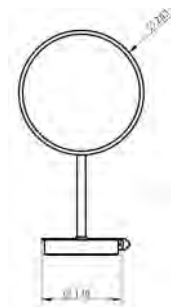
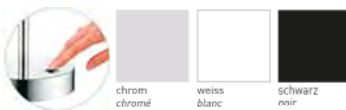

- Standmodell mit Kabel
- Vergrößerungsfaktor: 3x
- Farbton: 5500 K / weiss
- Schutzklasse: IP 44
- Netzanschluss: 230V / 50-60Hz
- *Modèle à poser avec câble*
- *Facteur d'agrandissement: 3x*
- *Température de couleur: 5500 K / blanc*
- *Indice de protection: IP 44*
- *Tension électrique: 230V / 50-60Hz*



Kosmetikspiegel Vizelo

Miroir cosmétique Vizelo



| | | | | | | |
|---|-------------------|---|---|---|---------------|---------------|
|  | 44 0304 01 | verchromt <i>chromé</i> 16.0 x 24.0 cm ; 3X | 1 |  | 157.50 | 169.63 |
|---|-------------------|---|---|---|---------------|---------------|

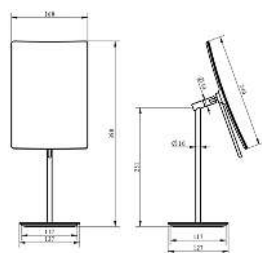

- Vergrößerungsfaktor: 3x
- *Facteur d'agrandissement: 3x*

ACCESSOIRES - Spiegel

ACCESSOIRES - Miroirs

| EAN-Nr. no EAN | Artikel Nr. no d'article | Beschreibung description | VPE ce | VE ue | UVP pro Stk. PVC CHF excl. | UVP pro Stk. PVC CHF incl. |
|-------------------|-----------------------------|-----------------------------|-----------|----------|----------------------------------|----------------------------------|
|-------------------|-----------------------------|-----------------------------|-----------|----------|----------------------------------|----------------------------------|

Kosmetikspiegel Vagos

Miroir cosmétique Vagos



- Vergrößerungsfaktor: 3x
- Facteur d'agrandissement: 3x



44 0305 01

verchromt
chromé
Ø 20 cm ; 3X

1



163.09

175.65

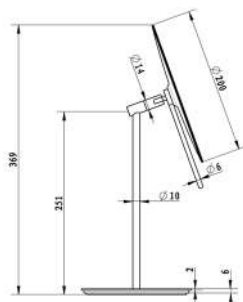

Kosmetikspiegel schwenkbar

Miroir cosmétique pivotant



mit Vergrößerungsspiegel
Vergrößerungsfaktor 1:3
avec miroir grossissant
facteur grossissant 1:3



45 1055 96

Messing verchromt
laiton chromé
Ø 18.7 cm ; FAKTOR 1:3

1



243.24

261.97

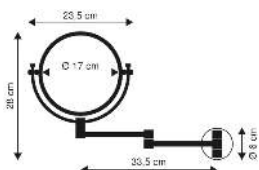

Spiegel rund mit Vergrößerung

Miroir rond agrandissant



mit Vergrößerungsspiegel
Vergrößerungsfaktor 1:2
avec miroir grossissant
facteur grossissant 1:2



45 1054 96

verchromt
chromé
Ø 17 cm

12



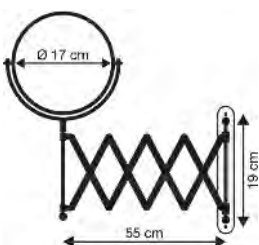

38.21

41.15



ACCESSOIRES - Spiegel

ACCESSOIRES - Miroirs

| | EAN-Nr. <i>no EAN</i> | Artikel Nr. <i>no d'article</i> | Beschreibung <i>description</i> | VPE <i>ce</i> | VE <i>ue</i> | UVP pro Stk. <i>PVC</i> CHF excl. | UVP pro Stk. <i>PVC</i> CHF incl. |
|---|---|------------------------------------|---|------------------|---|---|---|
| Kosmetikspiegel | | Miroir cosmétique | | | | | |
|  |  | 45 2027 20 | weiss / mit Tesa Powerstrips <i>blanc / avec Tesa Powerstrips</i> Ø 15CM ; 8 cm | 6 |  | 20.50 | 22.08 |























Einfache Befestigung ohne zu bohren und spurlos ablösbar, dank der Tesa Powerstrips® Technologie

Fixation facile sans avoir à effectuer de perçage et facilement détachable grâce à la technologie Tesa Powerstrips®

ACCESSOIRES - Duschablagen

ACCESSOIRES - Bacs à douche

| | EAN-Nr. no EAN | Artikel Nr. no d'article | Beschreibung description | VPE ce | VE ue | UVP pro Stk. PVC CHF excl. | UVP pro Stk. PVC CHF incl. |
|---|--|---------------------------------------|--|-----------|---|----------------------------------|----------------------------------|
| Duschablage rechteckig | | Bac à douche rectangulaire | | | | | |
|  |  7 611038 173371 | 45 1061 96 | Inox poliert <i>inox poli</i> 12.3 x 29 x 5.6 cm | 1 |  | 54.99 | 59.22 |
| |  | | | | | | |
| Duschablage dreieckig | | Bac à douche triangulaire | | | | | |
|  |  7 611038 173388 | 45 1061 97 | Inox poliert <i>inox poli</i> 20.6 x 20.6 x 5.6 cm | 1 |  | 58.71 | 63.23 |
| |  | | | | | | |
| Drahtkorb m.Saugnapf oval kurz | | Corb.en fil ovale courte vent. | | | | | |
|  |  7 611038 045432 | 45 2151 96 | verchromt <i>chromé</i> 25.5 x 11 x 4 cm | 1 |  | 27.49 | 29.61 |
| Stahl Acier |  | | | | | | |
| Drahtkorb rechteckig | | Corbeille file rectangulaire | | | | | |
|  |  8 003341 193549 | 45 2130 98 | verchromt / mit Saugnapf <i>chromé / avec ventouse</i> 27.5 x 13.6 x 12 cm | 4 |  | 35.88 | 38.64 |
| |  | | | | | | |
| Drahtkorb dreieckig | | Corbeille file triangulaire | | | | | |
|  |  8 003341 193556 | 45 2131 98 | verchromt / mit Saugnapf <i>chromé / avec ventouse</i> 19 x 19 x 10 cm | 4 |  | 33.08 | 35.63 |
| |  | | | | | | |

ACCESSOIRES - Duschablagen

ACCESSOIRES - Bacs à douche

| | EAN-Nr. no EAN | Artikel Nr. no d'article | Beschreibung description | VPE ce | VE ue | UVP pro Stk. PVC CHF excl. | UVP pro Stk. PVC CHF incl. |
|--|-------------------|-----------------------------|-----------------------------|-----------|----------|----------------------------------|----------------------------------|
|--|-------------------|-----------------------------|-----------------------------|-----------|----------|----------------------------------|----------------------------------|

Doppelhaken mit Saugnapf

Crochet double avec ventouse



45 2132 98

verchromt
chromé
6.3 x 3.5 x 10.8 cm

8



15.56

16.76



Eckregal mit 2 Ablagen

Etagère triang. à 2 étages



45 1051 96

Messing verchromt
Laiton chromé
18 x 18 x 18.5 x 26 cm

1



119.29

128.48

Eckregal mit 2 Ablagen

Etagère triang. à 2 étages



45 1051 97

Messing verchromt
Laiton chromé
18.8 x 18.8 x 25.8 x 36 cm

1



119.29

128.48

mit Wandhalterung
avec support murale





ACCESSOIRES - Duschablagen
ACCESSOIRES - Bacs à douche

| | EAN-Nr. <i>no EAN</i> | Artikel Nr. <i>no d'article</i> | Beschreibung <i>description</i> | VPE <i>ce</i> | VE <i>ue</i> | UVP pro Stk. <i>PVC</i> CHF excl. | UVP pro Stk. <i>PVC</i> CHF incl. |
|--|--------------------------|------------------------------------|------------------------------------|------------------|-----------------|---|---|
|--|--------------------------|------------------------------------|------------------------------------|------------------|-----------------|---|---|

Duschregal **Etagère salle de bain**



mit 4 Ablagen
à 4 étages



| | | | | | | |
|---|-------------------|--|---|---|--------------|--------------|
|  | 45 2310 40 | verchromt <i>chromé</i> 180 - 260 cm | 6 |  | 38.21 | 41.15 |
|  | 45 2310 41 | weiss <i>blanc</i> 180 - 260 cm | 6 |  | 34.48 | 37.14 |

ACCESSOIRES - TÜRGARDEROBEN

ACCESSOIRES - GARDEROBES POUR PORTE

| | EAN-Nr. no EAN | Artikel Nr. no d'article | Beschreibung description | VPE ce | VE ue | UVP pro Stk. PVC CHF excl. | UVP pro Stk. PVC CHF incl. |
|--|-------------------|-----------------------------|-----------------------------|-----------|----------|----------------------------------|----------------------------------|
|--|-------------------|-----------------------------|-----------------------------|-----------|----------|----------------------------------|----------------------------------|

| Türgarderobe | Garderobe pour porte | | | | | | |
|--------------|----------------------|--|--|--|--|--|--|
|--------------|----------------------|--|--|--|--|--|--|

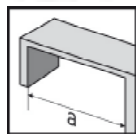

| | | | | | | | |
|---|--|-------------------|---------------------------------------|----|---|--------------|--------------|
|  |  7 611038 113698 | 45 2016 97 | verchromt chromé 61 x 12 x 6 cm | 36 |  | 27.96 | 30.11 |
|---|--|-------------------|---------------------------------------|----|---|--------------|--------------|



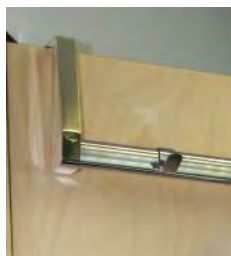

a = 1.8cm





| Ersatzhaken zu Türgarderobe | Crochets de rechange | | | | | | |
|-----------------------------|----------------------|--|--|--|--|--|--|
|-----------------------------|----------------------|--|--|--|--|--|--|

| | | | | | | | |
|--|--|-------------------|----------------------------------|---|---|-------------|--------------|
|  |  7 611038 088606 | 45 2016 98 | verchromt chromé 5 Stk/pcs | 5 |  | 9.97 | 10.74 |
|--|--|-------------------|----------------------------------|---|---|-------------|--------------|

| | | | | | | | |
|--|--|-------------------|-------------------------------|---|---|--------------|--------------|
|  |  7 611038 088613 | 45 2017 98 | farbig coloré 5 Stk/pcs | 5 |  | 10.62 | 11.44 |
|--|--|-------------------|-------------------------------|---|---|--------------|--------------|

| Türgarderobe | Garderobe pour porte | | | | | | |
|--------------|----------------------|--|--|--|--|--|--|
|--------------|----------------------|--|--|--|--|--|--|

| | | | | | | | |
|---|--|-------------------|----------------------------------|----|---|--------------|--------------|
|  |  7 611038 113704 | 45 2018 97 | weiss blanc 61 x 12 x 6 cm | 36 |  | 19.11 | 20.58 |
|---|--|-------------------|----------------------------------|----|---|--------------|--------------|

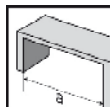

a = 1.8cm



ACCESSOIRES - TÜRGARDEROBEN

ACCESSOIRES - GARDEROBES POUR PORTE

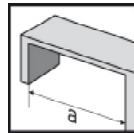

| EAN-Nr. no EAN | Artikel Nr. no d'article | Beschreibung description | VPE ce | VE ue | UVP pro Stk. PVC CHF excl. | UVP pro Stk. PVC CHF incl. |
|-------------------|-----------------------------|-----------------------------|-----------|----------|----------------------------------|----------------------------------|
|-------------------|-----------------------------|-----------------------------|-----------|----------|----------------------------------|----------------------------------|

| Türgarderobe Mann + Frau | | Garderobe porte homme + femme | | | | | |
|---|--|-------------------------------|--|---|---|--------------|--------------|
|  |  7 611038 045289 | 45 2011 97 | verchromt <i>chromé</i> 19 x 22 cm | 1 |  | 20.50 | 22.08 |



a = 2.2cm

Stahl
Acier

| Türgarderobe Familie | | Garderobe pour porte "famille" | | | | | |
|--|--|--------------------------------|--|---|---|--------------|--------------|
|  |  7 611038 045272 | 45 2010 97 | verchromt <i>chromé</i> 39.5 x 22 cm | 1 |  | 32.15 | 34.63 |

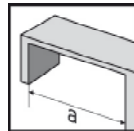

a = 2.2cm



Stahl
Acier

ACCESSOIRES - TÜRSCHILDER

ACCESSOIRES - PLAQUES POUR PORTE

| | EAN-Nr. no EAN | Artikel Nr. no d'article | Beschreibung description | VPE ce | VE ue | UVP pro Stk. PVC CHF excl. | UVP pro Stk. PVC CHF incl. |
|--|-------------------|-----------------------------|-----------------------------|-----------|----------|----------------------------------|----------------------------------|
|--|-------------------|-----------------------------|-----------------------------|-----------|----------|----------------------------------|----------------------------------|



Türschild Mann Plaque porte homme

| | | | | | | | |
|---|--|------------|--|---|---|-------|-------|
|  |  7 611038 049010 | 45 2020 01 | matt gebürstet <i>mat brossé</i> 8.2 cm ; 1 Stk/pc | 5 |  | 10.81 | 11.64 |
|---|--|------------|--|---|---|-------|-------|

Selbstklebend
Autocollant





Türschild Frau Plaque porte femme

| | | | | | | | |
|---|--|------------|--|----|---|-------|-------|
|  |  7 611038 049027 | 45 2020 02 | matt gebürstet <i>mat brossé</i> 8.2 cm ; 1 Stk/pc | 10 |  | 10.81 | 11.64 |
|---|--|------------|--|----|---|-------|-------|

Selbstklebend
Autocollant





Türschild Mann + Frau Plaque. porte homme+femme

| | | | | | | | |
|--|---|------------|--|---|--|-------|-------|
|  |  7 611038 049034 | 45 2020 03 | matt gebürstet <i>mat brossé</i> 8.2 cm ; 1 Stk/pc | 5 |  | 10.81 | 11.64 |
|--|---|------------|--|---|--|-------|-------|

Selbstklebend
Autocollant



Türschild Stehen verboten Plaque. porte debout interdit

| | | | | | | | |
|---|--|------------|--|---|---|-------|-------|
|  |  7 611038 049058 | 45 2020 05 | matt gebürstet <i>mat brossé</i> 8.2 cm ; 1 Stk/pc | 5 |  | 10.81 | 11.64 |
|---|--|------------|--|---|---|-------|-------|

Selbstklebend
Autocollant



ACCESSOIRES - HAKEN

ACCESSOIRES - CROCHETS

| | EAN-Nr. no EAN | Artikel Nr. no d'article | Beschreibung description | VPE ce | VE ue | UVP pro Stk. PVC CHF excl. | UVP pro Stk. PVC CHF incl. |
|--|-------------------|-----------------------------|-----------------------------|-----------|----------|----------------------------------|----------------------------------|
|--|-------------------|-----------------------------|-----------------------------|-----------|----------|----------------------------------|----------------------------------|

Hakenleiste mit 4 Haken

Barre à 4 crochets



35 56270 10

verchromt
chromé
20 cm ; 1 Stk/pc

5



12.12

13.05



35 56251 41

weiss
blanc
20 cm ; 1 Stk/pc

5



7.27

7.83

Selbstklebend oder zum
Schrauben
Autocollant ou à visser



Hakenleiste mit 5 Haken

Barre à 5 crochets



35 1011 96

weiss
blanc
18 cm ; 1 Stk/pc

5



17.52

18.87



35 1012 96

verchromt
chromé
18 cm ; 1 Stk/pc

5



23.76

25.59

Selbstklebend oder zum
Schrauben
Autocollant ou à visser



Hakenleiste mit 5 Haken

Barre à 5 crochets



35 1010 98

Messing verchromt
laiton chromé
24 cm ; 1 Stk/pc

5



30.29

32.62

Original Schweizer Ausführung
Modèle originale Suisse
Zum Schrauben
À visser

Haken Herz

Crochet coeur



35 7016 10

Inox matt
Inox mat
6.2 x 6 cm ; 1 Stk/pc

5



10.07

10.84







Selbstklebend
Autocollant





ACCESSOIRES - HAKEN

ACCESSOIRES - CROCHETS





| | EAN-Nr. no EAN | Artikel Nr. no d'article | Beschreibung description | VPE ce | VE ue | UVP pro Stk. PVC CHF excl. | UVP pro Stk. PVC CHF incl. |
|--|-------------------|-----------------------------|-----------------------------|-----------|----------|----------------------------------|----------------------------------|
|--|-------------------|-----------------------------|-----------------------------|-----------|----------|----------------------------------|----------------------------------|

| Haken Butterfly | | Crochet Butterfly | | | | | |
|---|--|-------------------|---|---|--|--------------|--------------|
|  |  7 611038 108625 | 35 7016 11 | Inox matt <i>Inox mat</i> 7 x 5 cm ; 1 Stk/pc | 5 |  1 | 11.28 | 12.14 |
| |  | | | | | | |

Selbstklebend
Autocollant

| Haken Seestern | | Crochet étoile de mer | | | | | |
|--|--|-----------------------|---|---|--|--------------|--------------|
|  |  7 611038 087333 | 35 7016 12 | Inox matt <i>Inox mat</i> 6.2 x 6 cm ; 1 Stk/pc | 5 |  1 | 11.28 | 12.14 |
| |  | | | | | | |

















Selbstklebend
Autocollant

| Haken Dorie | | Crochet Dorie | | | | | |
|---|--|-------------------|---|---|--|--------------|--------------|
|  |  7 611038 087425 | 35 7016 13 | Inox matt <i>Inox mat</i> 6.6 x 6 cm ; 1 Stk/pc | 5 |  1 | 11.28 | 12.14 |
| |  | | | | | | |

Selbstklebend
Autocollant

ACCESSOIRES - HAKEN





ACCESSOIRES - CROCHETS

| | EAN-Nr. no EAN | Artikel Nr. no d'article | Beschreibung description | VPE ce | VE ue | UVP pro Stk. PVC CHF excl. | UVP pro Stk. PVC CHF incl. |
|---|--|-----------------------------|--|-----------|---|----------------------------------|----------------------------------|
| Haken Hand | | Crochet main | | | | | |
|  |  7 611038 087845 | 35 7016 16 | Inox matt <i>Inox mat</i> 7 x 8.5 cm ; 1 Stk/pc | 5 |  | 7.97 | 8.58 |
| |  | | | | | | |
| Selbstklebend <i>Autocollant</i> | | | | | | | |
| Haken Fisch | | Crochet Poisson | | | | | |
|  |  7 611038 082970 | 35 60772 11 | Inox matt <i>Inox mat</i> 3.5 x 4 cm ; 2 Stk/pcs | 10 |  | 9.60 | 10.34 |
| |  | | | | | | |
| Selbstklebend <i>Autocollant</i> | | | | | | | |
| Haken Muschel | | Crochet coquillage | | | | | |
|  |  7 611038 088422 | 35 7016 22 | Inox matt <i>Inox mat</i> 2 Stk/pcs | 5 |  | 9.60 | 10.34 |
| |  | | | | | | |
| Selbstklebend <i>Autocollant</i> | | | | | | | |
| Haken rund | | Crochet rond | | | | | |
|  |  7 611038 056971 | 35 60872 11 | Inox matt <i>Inox mat</i> 3.5 x 3.8 cm ; 2 Stk/pcs | 5 |  | 9.60 | 10.34 |
| |  | | | | | | |
| Selbstklebend <i>Autocollant</i> | | | | | | | |





ACCESSOIRES - HAKEN

ACCESSOIRES - CROCHETS





| | EAN-Nr. no EAN | Artikel Nr. no d'article | Beschreibung description | VPE ce | VE ue | UVP pro Stk. PVC CHF excl. | UVP pro Stk. PVC CHF incl. |
|--|-------------------|-----------------------------|-----------------------------|-----------|----------|----------------------------------|----------------------------------|
|--|-------------------|-----------------------------|-----------------------------|-----------|----------|----------------------------------|----------------------------------|

| Haken oval | Crochet ovale | | | | | | |
|---|--|--------------------|--|---|---|-------------|--------------|
|  |  7 611038 056964 | 35 60972 11 | Inox matt <i>Inox mat</i> 2.8 x 4.5 cm ; 2 Stk/pcs | 5 |  | 9.60 | 10.34 |
| |  | | | | | | |

Selbstklebend
Autocollant

| Kleiderhaken 1-fach | Patère simple | | | | | | |
|--|--|-------------------|---|---|---|-------------|-------------|
|  |  7 611038 088453 | 35 7016 24 | verchromt <i>chromé</i> 2 Stk/pcs | 5 |  | 8.53 | 9.18 |
| |  | | | | | | |

Zum Schrauben
À visser

| Kleiderhaken 2-fach | Patère double | | | | | | |
|---|--|-------------------|---|---|---|-------------|-------------|
|  |  7 611038 088439 | 35 7016 23 | verchromt <i>chromé</i> 2 Stk/pcs | 5 |  | 8.81 | 9.49 |
| |  | | | | | | |

Zum Schrauben
À visser

ACCESSOIRES - HAKEN

ACCESSOIRES - CROCHETS

| | EAN-Nr. no EAN | Artikel Nr. no d'article | Beschreibung description | VPE ce | VE ue | UVP pro Stk. PVC CHF excl. | UVP pro Stk. PVC CHF incl. |
|--|-------------------|-----------------------------|-----------------------------|-----------|----------|----------------------------------|----------------------------------|
|--|-------------------|-----------------------------|-----------------------------|-----------|----------|----------------------------------|----------------------------------|

NEW

1er- Klemmhaken

1-Crochet-pince



45 1634 97

INOX matt
INOX mat
5 x 8 cm ; 1 Stk/pc

5



8.01

8.63

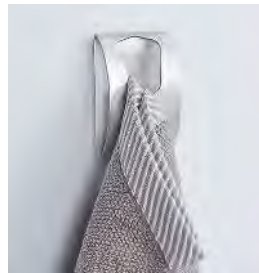

Selbstklebend
Autocollant

NEW

3er- Klemmhaken

3-Crochet-pince



45 1635 97

INOX matt
INOX mat
15 cm ; 1 Stk/pc

6



11.65



12.55



Selbstklebend oder zum
Schrauben
Autocollant ou à visser

ACCESSOIRES - HAKEN

ACCESSOIRES - CROCHETS

| | EAN-Nr. no EAN | Artikel Nr. no d'article | Beschreibung description | VPE ce | VE ue | UVP pro Stk. PVC CHF excl. | UVP pro Stk. PVC CHF incl. |
|---|--|-------------------------------------|--|-----------|---|----------------------------------|----------------------------------|
| Doppelhaken mit Saugnapf | | Crochet double avec ventouse | | | | | |
|  |  8 003341 193105 | 45 2132 98 | verchromt <i>chromé</i> 6.3 x 3.5 x 10.8 cm | 8 |  | 15.56 | 16.76 |
| |  | | | | | | |
| Saughaken | | Crochet ventouse | | | | | |
|  |  7 612693 630858 | 35 63085 01 | Draht, transparent <i>Fil, transparent</i> 4.2 x 4.2 cm ; 2 Stk/pcs | 5 |  | 2.89 | 3.11 |
| |  | | | | | | |
| Saughaken | | Crochet ventouse | | | | | |
|  |  7 611038 090180 | 35 7016 39 | Kunststoff, transparent <i>Plastique, transparent</i> 4.2 x 4.7 cm ; 2 Stk/pcs | 5 |  | 2.89 | 3.11 |
| |  | | | | | | |
| Hebelsauger | | Crochet ventouse | | | | | |
|  |  7 612693 632517 | 35 63251 41 | weiss <i>blanc</i> 6.3 x 4.7 cm ; 1 Stk/pc | 5 |  | 4.19 | 4.52 |
| |  | | | | | | |

ACCESSOIRES - HAKEN





ACCESSOIRES - CROCHETS

| | EAN-Nr. no EAN | Artikel Nr. no d'article | Beschreibung description | VPE ce | VE ue | UVP pro Stk. PVC CHF excl. | UVP pro Stk. PVC CHF incl. |
|--|-------------------|-----------------------------|-----------------------------|-----------|----------|----------------------------------|----------------------------------|
|--|-------------------|-----------------------------|-----------------------------|-----------|----------|----------------------------------|----------------------------------|

| | |
|----------------------------|--------------------------------|
| Lichterkettensauger | Ventouse pour guirlande |
|----------------------------|--------------------------------|

| | | | | | | | |
|---|--|---|---------------------------|---|---|-------------|-------------|
|  |  7 611038 115340 | 35 7010 01 | transparent 15 Stk/pcs | 5 |  | 8.15 | 8.78 |
| |  |  | | | | | |





| | |
|----------------------|-------------------------|
| Saugnapfhaken | Crochet ventouse |
|----------------------|-------------------------|

| | | | | | | | |
|---|---|-------------------|-------|---|--|-------------|-------------|
|  |  7 611038 140847 | 35 7017 50 | Panda | 1 |  | 5.92 | 6.37 |
| |  | | | | | | |

| | |
|----------------------|-------------------------|
| Saugnapfhaken | Crochet ventouse |
|----------------------|-------------------------|

| | | | | | | | |
|---|--|-------------------|-------|---|---|-------------|-------------|
|  |  7 611038 141127 | 35 7017 51 | Hippo | 1 |  | 5.92 | 6.37 |
| |  | | | | | | |

| | |
|----------------------|-------------------------|
| Saugnapfhaken | Crochet ventouse |
|----------------------|-------------------------|

| | | | | | | | |
|---|--|-------------------|----------------------|---|---|-------------|-------------|
|  |  7 611038 141134 | 35 7017 52 | Frosch Grenouille | 1 |  | 5.92 | 6.37 |
| |  | | | | | | |









ACCESSOIRES - HAKEN

ACCESSOIRES - CROCHETS

| EAN-Nr. no EAN | Artikel Nr. no d'article | Beschreibung description | VPE ce | VE ue | UVP pro Stk. PVC CHF excl. | UVP pro Stk. PVC CHF incl. |
|-------------------|-----------------------------|-----------------------------|-----------|----------|----------------------------------|----------------------------------|
|-------------------|-----------------------------|-----------------------------|-----------|----------|----------------------------------|----------------------------------|

Minihaken oval









Microchets ovale

| | | | | | | | |
|--|--|--------------------|--|---|---|-------------|-------------|
|  <p>Selbstklebend Autocollant</p> |  7 612693 504517 | 35 50451 41 | weiss <i>blanc</i> 2.5 x 1.5 cm ; 6 Stk/pcs | 5 |  | 4.57 | 4.92 |
| |  7 612693 504548 | 35 50454 08 | granit 2.5 x 1.5 cm ; 6 Stk/pcs | 5 |  | 4.57 | 4.92 |
| |  7 611038 082956 | 35 50455 01 | transparent <i>transparente</i> 2.5 x 1.5 cm ; 6 Stk/pcs | 5 |  | 5.45 | 5.87 |
| |  7 611038 057176 | 35 50740 10 | verchromt <i>chromé</i> 2.5 x 1.5 cm ; 6 Stk/pcs | 5 |  | 5.82 | 6.27 |



Haken oval mittel





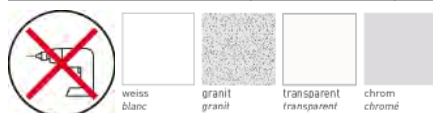



Crochets ovale medium

| | | | | | | | |
|---|--|--------------------|--|---|---|-------------|-------------|
|  <p>Selbstklebend Autocollant</p> |  7 612693 503510 | 35 50351 41 | weiss <i>blanc</i> 4.2 x 2.6 cm ; 3 Stk/pcs | 5 |  | 3.91 | 4.22 |
| |  7 612693 503541 | 35 50354 08 | granit 4.2 x 2.6 cm ; 3 Stk/pcs | 5 |  | 3.91 | 4.22 |
| |  7 611038 057220 | 35 50385 01 | transparent 4.2 x 2.6 cm ; 3 Stk/pcs | 5 |  | 3.91 | 4.22 |
| |  7 611038 083922 | 35 50351 10 | chrom <i>chromé</i> 4.2 x 2.6 cm ; 3 Stk/pcs | 5 |  | 5.13 | 5.52 |



Haken oval gross

Crochets ovale grands

| | | | | | | | |
|--|--|--------------------|--|---|---|-------------|-------------|
|  <p>Selbstklebend Autocollant</p> |  7 612693 509512 | 35 50951 41 | weiss <i>blanc</i> 5.1 x 4.3 cm ; 2 Stk/pcs | 5 |  | 5.36 | 5.77 |
| |  7 612693 509543 | 35 50954 08 | granit 5.1 x 4.3 cm ; 2 Stk/pcs | 5 |  | 5.27 | 5.67 |
| |  7 611038 082963 | 35 50955 01 | transparent 5.1 x 4.3 cm ; 2 Stk/pcs | 5 |  | 5.36 | 5.77 |
| |  7 611038 115456 | 35 50950 10 | verchromt <i>chromé</i> 5.1 x 4.3 cm ; 2 Stk/pcs | 5 |  | 6.20 | 6.67 |



ACCESSOIRES - HAKEN

ACCESSOIRES - CROCHETS





| | EAN-Nr. no EAN | Artikel Nr. no d'article | Beschreibung description | VPE ce | VE ue | UVP pro Stk. PVC CHF excl. | UVP pro Stk. PVC CHF incl. |
|--|-------------------|-----------------------------|-----------------------------|-----------|----------|----------------------------------|----------------------------------|
|--|-------------------|-----------------------------|-----------------------------|-----------|----------|----------------------------------|----------------------------------|

Haken oval

Crochets ovale



Selbstklebend
Autocollant

| | | | | | | |
|---|--------------------|--|---|---|-------------|-------------|
|  | 35 50251 41 | weiss <i>blanc</i> 5.5 x 3.4 cm ; 2 Stk/pcs | 5 |  | 4.66 | 5.02 |
|  | 35 50270 10 | chrom <i>chromé</i> 5.5 x 3.4 cm ; 2 Stk/pcs | 5 |  | 5.82 | 6.27 |

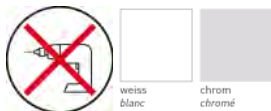





Haken rund

Crochets rond



Selbstklebend
Autocollant

| | | | | | | |
|---|--------------------|--|---|---|-------------|-------------|
|  | 35 50051 41 | weiss <i>blanc</i> 3.6 x 3.6 cm ; 2 Stk/pcs | 5 |  | 4.66 | 5.02 |
|  | 35 50070 09 | chrom <i>chromé</i> 3.6 x 3.6 cm ; 2 Stk/pcs | 5 |  | 5.36 | 5.77 |

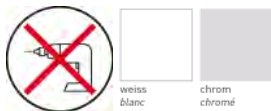





Lotushaken

Crochets Lotus



Selbstklebend
Autocollant

| | | | | | | |
|---|--------------------|--|---|---|-------------|-------------|
|  | 35 50651 41 | weiss <i>blanc</i> 4.3 x 4.4 cm ; 2 Stk/pcs | 5 |  | 4.57 | 4.92 |
|  | 35 50670 10 | chrom <i>chromé</i> 4.3 x 4.4 cm ; 2 Stk/pcs | 5 |  | 5.82 | 6.27 |





Klemmhaken

Crochet-pince



Selbstklebend
Autocollant

| | | | | | | |
|---|--------------------|---|---|---|-------------|-------------|
|  | 35 58751 41 | weiss <i>blanc</i> 4.8 x 3.4 cm ; 2 Stk/pcs | 5 |  | 3.68 | 3.96 |
|---|--------------------|---|---|---|-------------|-------------|



ACCESSOIRES - HAKEN

ACCESSOIRES - CROCHETS

| | EAN-Nr. no EAN | Artikel Nr. no d'article | Beschreibung description | VPE ce | VE ue | UVP pro Stk. PVC CHF excl. | UVP pro Stk. PVC CHF incl. |
|--|-------------------|-----------------------------|-----------------------------|-----------|----------|----------------------------------|----------------------------------|
|--|-------------------|-----------------------------|-----------------------------|-----------|----------|----------------------------------|----------------------------------|

Gardinenhaken

Crochets pour rideau



Selbstklebend
Autocollant



7 612693 582515

35 58251 41

weiss
blanc
2.8 x 1.9 cm ; 4 Stk/pcs

5



4.66

5.02



Clip Haken

Crochet clip



7 612693 763518

35 76351 41

weiss
blanc
4.0 x 2.4 cm ; 5 Stk/pcs

5



3.59

3.86

NEW

Haken mit 2 Armen

Crochet avec 2 bras



Selbstklebend
Autocollant



7 611038 249632

35 5826 97

weiss
blanc
4.5 x 3 x 7.5 cm ; 1 Stk/pc

5



5.92

6.37

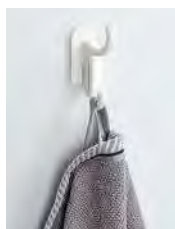

Klipp-Klapp Haken

Crochet Klipp-Klapp



7 612693 762504

35 76250 00

assortiert
assorti
5.5 x 1.6 cm ; 5 Stk/pcs

5



3.08

3.31

ACCESSOIRES - HAKEN

ACCESSOIRES - CROCHETS

| EAN-Nr. <i>no EAN</i> | Artikel Nr. <i>no d'article</i> | Beschreibung <i>description</i> | VPE <i>ce</i> | VE <i>ue</i> | UVP pro Stk. <i>PVC</i> CHF excl. | UVP pro Stk. <i>PVC</i> CHF incl. |
|--------------------------|------------------------------------|------------------------------------|------------------|-----------------|---|---|
|--------------------------|------------------------------------|------------------------------------|------------------|-----------------|---|---|

Haken für Heizkörper

Crochet pour radiateur

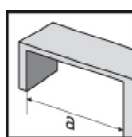

| | | | | | | | |
|---|--|-------------------|---|---|---|-------|-------|
|  |  7 611038 130435 | 35 7017 02 | weiss <i>blanc</i> 3.2 x 6.7 x 12 cm ; 1 Stk/pc | 4 |  | 12.02 | 12.95 |
| |  7 611038 130459 | 35 7017 14 | schwarz <i>noir</i> 3.2 x 6.7 x 12 cm ; 1 Stk/pc | 4 |  | 12.02 | 12.95 |
| |  7 611038 130466 | 35 7017 20 | pink transparent <i>rose vif transparent</i> 3.2 x 6.7 x 12 cm ; 1 Stk/pc | 4 |  | 12.02 | 12.95 |
| |  7 611038 130473 | 35 7017 21 | blau transparent <i>bleu transparent</i> 3.2 x 6.7 x 12 cm ; 1 Stk/pc | 4 |  | 12.02 | 12.95 |
| |  7 611038 142766 | 35 7017 24 | orange transparent 3.2 x 6.7 x 12 cm ; 1 Stk/pc | 4 |  | 12.02 | 12.95 |
| |  7 611038 130497 | 35 7017 28 | grün transparent <i>vert transparent</i> 3.2 x 6.7 x 12 cm ; 1 Stk/pc | 4 |  | 12.02 | 12.95 |
| |  7 611038 130503 | 35 7017 29 | lila transparent <i>lilas transparent</i> 3.2 x 6.7 x 12 cm ; 1 Stk/pc | 4 |  | 12.02 | 12.95 |
| |  7 611038 129538 | 35 7017 00 | transparent 3.2 x 6.7 x 12 cm ; 1 Stk/pc | 4 |  | 12.02 | 12.95 |
| |  7 611038 130442 | 35 7017 13 | verchromt <i>chromé</i> 3.2 x 6.7 x 12 cm ; 1 Stk/pc | 4 |  | 12.77 | 13.75 |



a = 2.6cm

Türhaken

Crochet pour la porte

| | | | | | | | |
|---|--|-------------------|---|---|---|------|------|
|  |  7 611038 056773 | 35 7014 41 | weiss <i>blanc</i> 1.1 x 8 cm ; 4 Stk/pcs | 5 |  | 3.96 | 4.27 |
|---|--|-------------------|---|---|---|------|------|

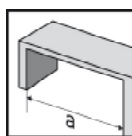



a = 2.0cm



ACCESSOIRES - HAKEN

ACCESSOIRES - CROCHETS

| | EAN-Nr. <i>no EAN</i> | Artikel Nr. <i>no d'article</i> | Beschreibung <i>description</i> | VPE <i>ce</i> | VE <i>ue</i> | UVP pro Stk. <i>PVC</i> CHF excl. | UVP pro Stk. <i>PVC</i> CHF incl. |
|--|--------------------------|------------------------------------|------------------------------------|------------------|-----------------|---|---|
|--|--------------------------|------------------------------------|------------------------------------|------------------|-----------------|---|---|

| Ausziehbare Wäscheleine | | Sèche linge retractable | | | | | |
|---|--|-------------------------|---|---|---|--------------|--------------|
|  |  8 003341 105689 | 35 5628 97 | Edelstahl <i>acier inoxydable</i> Ø 9 x 6 cm ; GESAMTLÄNGE 270CM | 8 |  | 38.68 | 41.65 |

Ausziehbar bis 2.7 Meter
Maximale Traglast 2 KG
extensible jusqu'à 2.7 mètres
charge maximale: 2 kg

| Fensterhaken | | Crochet de fenêtre | | | | | |
|---|--|--------------------|--|---|---|-------------|-------------|
|  |  7 611038 163273 | 35 7020 98 | weiss <i>blanc</i> 2 x 1.6 x 3.5 cm ; 4 Stk/pc | 5 |  | 4.47 | 4.82 |

ACCESSOIRES Steckschlüssel

ACCESSOIRES - Clé à tube

| EAN-Nr. <i>no EAN</i> | Artikel Nr. <i>no d'article</i> | Beschreibung <i>description</i> | VPE <i>ce</i> | VE <i>ue</i> | UVP pro Stk. <i>PVC</i> CHF excl. | UVP pro Stk. <i>PVC</i> CHF incl. |
|--------------------------|------------------------------------|------------------------------------|------------------|-----------------|---|---|
|--------------------------|------------------------------------|------------------------------------|------------------|-----------------|---|---|

Steckschlüssel

Clé à tube



35 63261 41

Messing vernickelt
Laiton nicklé
7.5 mm

5



19.11

20.58

Heizkörperschlüssel

Clés pour radiateur



35 51116 80

verzinkt
zingué
5.0 mm ; 2 Stk/pcs

5



6.20

6.67

ACCESSOIRES - Badeenten

ACCESSOIRES - Canards de bain

| | EAN-Nr. no EAN | Artikel Nr. no d'article | Beschreibung description | VPE ce | VE ue | UVP pro Stk. PVC CHF excl. | UVP pro Stk. PVC CHF incl. |
|--|-------------------|-----------------------------|-----------------------------|-----------|----------|----------------------------------|----------------------------------|
|--|-------------------|-----------------------------|-----------------------------|-----------|----------|----------------------------------|----------------------------------|

Froschkönig

Roi grenouille



35 7460 94

grün
vert
7 x 7 x 8 cm

6



9.27

9.99

100% Naturkautschuk
100% caoutchouc naturel

Badeente mit Herz

Canard de bain avec coeur



35 7461 94

gelb
jaune
9 x 8 x 7.5 cm

6



9.27

9.99

100% Naturkautschuk
100% caoutchouc naturel

Krokodil

Crocodile



35 7462 94

grün
vert
5.5 x 7 x 2 cm

6



9.27

9.99

100% Naturkautschuk
100% caoutchouc naturel

Badeente I like

Canard de bain I like



35 7463 94

gelb
jaune
8 x 8 x 9 cm

6



9.27

9.99

100% Naturkautschuk
100% caoutchouc naturel



ACCESSOIRES - Badeenten

ACCESSOIRES - Canards de bain

| EAN-Nr. no EAN | Artikel Nr. no d'article | Beschreibung description | VPE ce | VE ue | UVP pro Stk. PVC CHF excl. | UVP pro Stk. PVC CHF incl. |
|-------------------|-----------------------------|-----------------------------|-----------|----------|----------------------------------|----------------------------------|
|-------------------|-----------------------------|-----------------------------|-----------|----------|----------------------------------|----------------------------------|

Badeente Putzfrau Canard de bain femme de ménage





| | | | | | | |
|--|-------------------|-------------------------------|---|---|--------------|--------------|
|  8 424678 008298 | 35 7464 94 | gelb jaune 8 x 8 x 9 cm | 6 |  | 11.74 | 12.65 |
|--|-------------------|-------------------------------|---|---|--------------|--------------|

100% Naturkautschuk
100% caoutchouc naturel

Badeente "Bunny" Canard de bain Bunny





| | | | | | | |
|--|-------------------|-------------------------------|---|---|--------------|--------------|
|  8 424678 008397 | 35 7465 94 | gelb jaune 8 x 8 x 9 cm | 6 |  | 11.74 | 12.65 |
|--|-------------------|-------------------------------|---|---|--------------|--------------|

100% Naturkautschuk
100% caoutchouc naturel

Badeente Koch Canard de bain cuisinier





| | | | | | | |
|--|-------------------|-------------------------------|---|---|--------------|--------------|
|  8 424678 008540 | 35 7467 94 | gelb jaune 8 x 8 x 9 cm | 6 |  | 11.74 | 12.65 |
|--|-------------------|-------------------------------|---|---|--------------|--------------|

100% Naturkautschuk
100% caoutchouc naturel

Badeente Regenwetter Canard de bain temps pluvieux



| | | | | | | |
|--|-------------------|-------------------------------|---|---|--------------|--------------|
|  8 424678 008618 | 35 7468 94 | gelb jaune 8 x 8 x 9 cm | 6 |  | 11.74 | 12.65 |
|--|-------------------|-------------------------------|---|---|--------------|--------------|



100% Naturkautschuk
100% caoutchouc naturel

4.80

ACCESSOIRES - Badeenten

ACCESSOIRES - Canards de bain



| EAN-Nr. no EAN | Artikel Nr. no d'article | Beschreibung description | VPE ce | VE ue | UVP pro Stk. PVC CHF excl. | UVP pro Stk. PVC CHF incl. |
|-------------------|-----------------------------|-----------------------------|-----------|----------|----------------------------------|----------------------------------|
|-------------------|-----------------------------|-----------------------------|-----------|----------|----------------------------------|----------------------------------|

| Badeente Fussball | | Canard de bain football | | | | | |
|---|--|-------------------------|-------------------------------|---|---|--------------|--------------|
|  |  8 424678 008939 | 35 7469 94 | gelb jaune 8 x 8 x 9 cm | 6 |  | 11.74 | 12.65 |



100% Naturkautschuk
100% caoutchouc naturel

| Badeente Miss Liberty | | Canard de bain Miss Liberty | | | | | |
|--|--|-----------------------------|-------------------------------|---|---|--------------|--------------|
|  |  8 424678 009462 | 35 7470 94 | gelb jaune 8 x 8 x 9 cm | 6 |  | 11.74 | 12.65 |

100% Naturkautschuk
100% caoutchouc naturel

| Badeente Krankenschwester | | Canard de bain infirmière | | | | | |
|---|--|---------------------------|-------------------------------|---|---|--------------|--------------|
|  |  8 424678 009486 | 35 7471 94 | gelb jaune 8 x 8 x 9 cm | 6 |  | 11.74 | 12.65 |

100% Naturkautschuk
100% caoutchouc naturel



| Badeente Hawaii | | Canard de bain Hawaii | | | | | |
|---|--|-----------------------|-------------------------------|---|---|--------------|--------------|
|  |  8 424678 008045 | 35 7472 94 | gelb jaune 8 x 8 x 9 cm | 6 |  | 13.14 | 14.15 |

100% Naturkautschuk
100% caoutchouc naturel



ACCESSOIRES - Badeenten

ACCESSOIRES - Canards de bain



| | EAN-Nr. no EAN | Artikel Nr. no d'article | Beschreibung description | VPE ce | VE ue | UVP pro Stk. PVC CHF excl. | UVP pro Stk. PVC CHF incl. |
|--|-------------------|-----------------------------|-----------------------------|-----------|----------|----------------------------------|----------------------------------|
|--|-------------------|-----------------------------|-----------------------------|-----------|----------|----------------------------------|----------------------------------|

| Badeente Urlaub | | Canard de bain vacances | | | | | |
|---|--|-------------------------|-------------------------------|---|---|-------|-------|
|  |  8 424678 008434 | 35 7473 94 | gelb jaune 8 x 8 x 9 cm | 6 |  | 13.14 | 14.15 |



100% Naturkautschuk
100% caoutchouc naturel

| Badeente Ali Baba | | Canard de bain Ali Baba | | | | | |
|--|--|-------------------------|--------------------------------|---|---|-------|-------|
|  |  8 424678 008069 | 35 7474 94 | gelb jaune 8 x 8 x 10 cm | 6 |  | 13.14 | 14.15 |

100% Naturkautschuk
100% caoutchouc naturel

| Badeente Skifahrer | | Canard de bain skieur | | | | | |
|---|--|-----------------------|-------------------------------|---|---|-------|-------|
|  |  8 424678 008779 | 35 7475 94 | gelb jaune 8 x 8 x 9 cm | 6 |  | 13.14 | 14.15 |

100% Naturkautschuk
100% caoutchouc naturel



| Badeente Handwerker | | Canard de bain artisan | | | | | |
|---|--|------------------------|-------------------------------|---|---|-------|-------|
|  |  8 424678 008984 | 35 7476 94 | gelb jaune 8 x 8 x 9 cm | 6 |  | 13.14 | 14.15 |

100% Naturkautschuk
100% caoutchouc naturel



ACCESSOIRES - Badeenten

ACCESSOIRES - Canards de bain



| | EAN-Nr. no EAN | Artikel Nr. no d'article | Beschreibung description | VPE ce | VE ue | UVP pro Stk. PVC CHF excl. | UVP pro Stk. PVC CHF incl. |
|--|-------------------|-----------------------------|-----------------------------|-----------|----------|----------------------------------|----------------------------------|
|--|-------------------|-----------------------------|-----------------------------|-----------|----------|----------------------------------|----------------------------------|

| Badeente Pool Chill | | Canard de bain piscine | | | | | |
|---|--|------------------------|--------------------------------|---|---|-------|-------|
|  |  8 424678 009523 | 35 7477 94 | gelb jaune 6 x 12 x 7 cm | 6 |  | 15.84 | 17.06 |



100% Naturkautschuk
100% caoutchouc naturel

| Badeente "Au Vin" | | Canard de bain Au vin | | | | | |
|--|--|-----------------------|-------------------------------|---|---|-------|-------|
|  |  8 424678 009271 | 35 7478 94 | gelb jaune 8 x 8 x 9 cm | 6 |  | 13.14 | 14.15 |

100% Naturkautschuk
100% caoutchouc naturel

| Badeente Ahoi | | Canard de bain Ahoi | | | | | |
|---|--|---------------------|----------------------------------|---|---|-------|-------|
|  |  8 424678 010437 | 35 7479 94 | gelb jaune 13 x 13 x 10 cm | 6 |  | 15.84 | 17.06 |

100% Naturkautschuk
100% caoutchouc naturel



| Badeente Buch | | Canard de bain Livre | | | | | |
|---|--|----------------------|-------------------------------|---|---|-------|-------|
|  |  8 424678 008533 | 35 7480 94 | gelb jaune 8 x 8 x 9 cm | 6 |  | 11.74 | 12.65 |

100% Naturkautschuk
100% caoutchouc naturel



ACCESSOIRES - Badeenten

ACCESSOIRES - Canards de bain



| | EAN-Nr. no EAN | Artikel Nr. no d'article | Beschreibung description | VPE ce | VE ue | UVP pro Stk. PVC CHF excl. | UVP pro Stk. PVC CHF incl. |
|--|-------------------|-----------------------------|-----------------------------|-----------|----------|----------------------------------|----------------------------------|
|--|-------------------|-----------------------------|-----------------------------|-----------|----------|----------------------------------|----------------------------------|

| Badeente Baby | | Canard de bain Baby | | | | | |
|---|--|---------------------|---------------------------------|---|---|------|------|
|  |  8 424678 007086 | 35 7481 94 | gelb jaune 8 x 6 x 5.5 cm | 6 |  | 9.27 | 9.99 |



100% Naturkautschuk
100% caoutchouc naturel

| Badeente Classic | | Canard de bain Classic | | | | | |
|--|--|------------------------|-------------------------------|---|---|------|------|
|  |  8 424678 008052 | 35 7482 94 | gelb jaune 8 x 9 x 6 cm | 6 |  | 9.27 | 9.99 |

100% Naturkautschuk
100% caoutchouc naturel

| Badeente Taucher | | Canard de bain plongeur | | | | | |
|---|--|-------------------------|-------------------------------|---|---|------|------|
|  |  8 424678 007154 | 35 7485 94 | gelb jaune 6 x 7 x 4 cm | 6 |  | 9.27 | 9.99 |

100% Naturkautschuk
100% caoutchouc naturel

| Badeente Alphorn | | Canard de bain cor des alpes | | | | | |
|---|--|------------------------------|------------------------------------|---|---|-------|-------|
|  |  8 424678 009578 | 35 7486 94 | gelb jaune 14 x 6.5 x 9.0 cm | 6 |  | 13.14 | 14.15 |

100% Naturkautschuk
100% caoutchouc naturel

ACCESSOIRES - Badeenten

ACCESSOIRES - Canards de bain



| EAN-Nr. <i>no EAN</i> | Artikel Nr. <i>no d'article</i> | Beschreibung <i>description</i> | VPE <i>ce</i> | VE <i>ue</i> | UVP pro Stk. <i>PVC</i> CHF excl. | UVP pro Stk. <i>PVC</i> CHF incl. |
|--------------------------|------------------------------------|------------------------------------|------------------|-----------------|---|---|
|--------------------------|------------------------------------|------------------------------------|------------------|-----------------|---|---|

Badeente Wilhelm Tell

Canard de bain Guillome Tell



100% Naturkautschuk
100% caoutchouc naturel



| | | | | | | |
|--|-------------------|---|---|---|--------------|--------------|
|  8 424678 009585 | 35 7487 94 | gelb <i>jaune</i> 7.5 x 6.8 x 10.0 cm | 6 |  | 13.14 | 14.15 |
|--|-------------------|---|---|---|--------------|--------------|

Badeente Dracula

Canard de bain Dracula

















100% Naturkautschuk
100% caoutchouc naturel

| | | | | | | |
|--|-------------------|---|---|---|--------------|--------------|
|  8 424678 008199 | 35 7488 94 | gelb <i>jaune</i> 8.0 x 7.0 x 8.0 | 6 |  | 11.74 | 12.65 |
|--|-------------------|---|---|---|--------------|--------------|

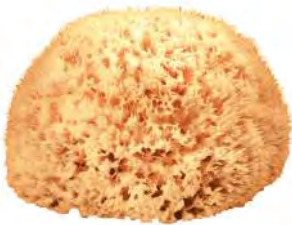













ACCESSOIRES - Croll & Denecke

| | EAN-Nr. no EAN | Artikel Nr. no d'article | Beschreibung description | VPE ce | VE ue | UVP pro Stk. PVC CHF excl. | UVP pro Stk. PVC CHF incl. |
|---|---|--|--------------------------------------|-----------|---|----------------------------------|----------------------------------|
| Massagegurt Sisal fein | | Ceinture de Massage Sisal fin | | | | | |
|  |  | 47 0120 10 | | 1 |  | 31.69 | 34.13 |
| Flachsgurt | | Ceinture en lin | | | | | |
|  |  | 47 0120 08 | 21.5 x 14 x 5.5 cm | 1 |  | 35.41 | 38.14 |
| Massagegurt | | Ceinture massage Sisal&Frotté | | | | | |
|  |  | 47 0120 19 | Sisal und Frottée Sisal et Frotté | 1 |  | 36.81 | 39.65 |
| Flachshandschuh | | Gant en lin | | | | | |
|  |  | 47 0120 09 | 32 x 1 x 15 cm | 1 |  | 23.76 | 25.59 |
| Badehandschuh | | Gant de bain | | | | | |
|  |  | 47 0120 24 | Luffa 21 x 16 x 1 cm | 1 |  | 17.43 | 18.77 |



















ACCESSOIRES - Croll & Denecke

| | EAN-Nr. no EAN | Artikel Nr. no d'article | Beschreibung description | VPE ce | VE ue | UVP pro Stk. PVC CHF excl. | UVP pro Stk. PVC CHF incl. |
|---|--|--------------------------------------|--|-----------|---|----------------------------------|----------------------------------|
| Massagehandschuh | | Gant de massage | | | | | |
|  |  4 009463 600136 | 47 0120 20 | Sisal und Frotté <i>Sisal et Frotté</i> 32 x 1 x 15 cm | 1 |  | 23.30 | 25.09 |
| Massagehandschuh Sisal fein | | Gant de Massage Sisal fin | | | | | |
|  |  4 009463 600150 | 47 0120 11 | 14 x 4 x 26 cm | 1 |  | 26.56 | 28.61 |
| Baumwollhandschuh mit Leinen | | Gants cotton avec lin | | | | | |
|  |  4 009463 600303 | 47 0120 13 | 14 x 4 x 26 cm | 1 |  | 25.63 | 27.60 |
| Naturschwamm | | Éponge nature | | | | | |
|  |  4 009463 401306 | 47 0120 16 | 13 cm | 1 |  | 30.75 | 33.12 |
| Badebürste Stiel abnehmbar | | Brosse bain manche démontable | | | | | |
|  |  4 009463 600709 | 47 0120 28 | Luffa 41 cm | 1 |  | 15.75 | 16.96 |















ACCESSOIRES - Croll & Denecke

| | EAN-Nr. no EAN | Artikel Nr. no d'article | Beschreibung description | VPE ce | VE ue | UVP pro Stk. PVC CHF excl. | UVP pro Stk. PVC CHF incl. |
|---|--|-------------------------------------|---|-----------|---|----------------------------------|----------------------------------|
| Badebürste | | Brosse de bain | | | | | |
|  |  4 009463 600716 | 47 0120 58 | mit Wildschweinborsten <i>avec poils de sanglier</i> 42.5 cm | 1 |  | 17.89 | 19.27 |
| Badebürste mit Massagenoppen | | Brosse avec dentures massage | | | | | |
|  |  4 009463 600969 | 47 0120 94 | kurzer Stiel <i>manche court</i> 20 cm | 1 |  | 23.30 | 25.09 |
| Badebürste | | Brosse | | | | | |
|  |  4 009463 600693 | 47 0120 88 | Bambus mit Kokosborsten <i>Bambou avec poils de coco</i> 36 cm | 1 |  | 26.09 | 28.10 |
| Saunabürste | | Brosse de bain sauna | | | | | |
|  |  4 009463 600730 | 47 0120 59 | Ahorn mit Wildschweinborsten <i>Érable avec poils de sanglier</i> 37 cm | 1 |  | 25.63 | 27.60 |
| Badebürste mit gebogenem Stiel | | Brosse de bain manche courbé | | | | | |
|  |  4 009463 600761 | 47 0120 29 | mit Wildschweinborsten <i>avec poils de sanglier</i> 48 cm | 1 |  | 26.09 | 28.10 |















ACCESSOIRES - Croll & Denecke

| | EAN-Nr. no EAN | Artikel Nr. no d'article | Beschreibung description | VPE ce | VE ue | UVP pro Stk. PVC CHF excl. | UVP pro Stk. PVC CHF incl. |
|---|--|---------------------------------------|---|-----------|---|----------------------------------|----------------------------------|
| Badebürste, abnehmbarer Kopf | | Brosse bain, manche démontable | | | | | |
|  |  4 009463 600976 | 47 0120 62 | mit Wildschweinborsten avec poils de sanglier 45.5 cm | 1 |  | 29.82 | 32.12 |
| Massagebürste | | Brosse de massage | | | | | |
|  |  4 009463 604899 | 47 0120 26 | Sisal 38.5 cm | 1 |  | 31.69 | 34.13 |
| Cellulite-Bürste | | Brosse anti-cellulite | | | | | |
|  |  4 009463 600808 | 47 0120 48 | mit Holznoppen avec picots en bois 43.5 cm | 1 |  | 26.09 | 28.10 |
| Handmassagebürste | | Brosse de massage à mains | | | | | |
|  |  4 009463 600952 | 47 0120 63 | mit Holzknauf avec poignée centrale Ø 11 x 7.5 cm | 1 |  | 15.19 | 16.36 |
| Cellulite-Handbürste | | Brosse à main anti-cellulite | | | | | |
|  |  4 009463 600983 | 47 0120 61 | mit Holznoppen avec picots en bois 13.5 x 9 x 7 cm | 1 |  | 17.43 | 18.77 |
| Badebürste eckig | | Brosse de bain angulaire | | | | | |
|  |  4 009463 600747 | 47 0120 27 | mit Wildschweinborsten avec poils de sanglier 20 cm | 1 |  | 17.43 | 18.77 |

ACCESSOIRES - Croll & Denecke

| | EAN-Nr. no EAN | Artikel Nr. no d'article | Beschreibung description | VPE ce | VE ue | UVP pro Stk. PVC CHF excl. | UVP pro Stk. PVC CHF incl. |
|---|--|------------------------------|--|-----------|---|----------------------------------|----------------------------------|
| Badebürste rund | | Brosse de bain ronde | | | | | |
|  |  4 009463 600754 | 47 0120 92 | mit Wildschweinborsten <i>avec poils de sanglier</i> 25 cm | 1 |  | 19.11 | 20.58 |
| Cellulite-Handbürste | | Brosse anti-cellulite | | | | | |
|  |  4 009463 600938 | 47 0120 95 | mit Holzknoppen <i>avec picots en bois</i> | 1 |  | 19.11 | 20.58 |
| Gesichtsbürste | | Brosse de visage | | | | | |
|  |  4 009463 202507 | 47 0120 98 | mit Naturborsten <i>avec soies naturelles</i> | 1 |  | 10.53 | 11.34 |
| Nagelbürste | | Brosse à ongles | | | | | |
|  |  4 009463 202408 | 47 0120 99 | mit Naturborsten <i>avec soies naturelles</i> | 1 |  | 10.25 | 11.04 |
| Nagelbürste | | Brosse à ongles | | | | | |
|  |  4 009463 202101 | 47 0121 22 | mit Naturbimsstein <i>avec pierre ponce</i> | 1 |  | 7.69 | 8.28 |

ACCESSOIRES - Croll & Denecke

| | EAN-Nr. no EAN | Artikel Nr. no d'article | Beschreibung description | VPE ce | VE ue | UVP pro Stk. PVC CHF excl. | UVP pro Stk. PVC CHF incl. |
|---|--|--------------------------------------|---|-----------|---|----------------------------------|----------------------------------|
| Bimsblock mit Kordel | | Pierre ponce avec corde | | | | | |
|  |  4 009463 202309 | 47 0120 17 | 15.4 x 2 x 5 cm | 1 |  | 7.08 | 7.63 |
| Fussmassageroller | | Rouleau de massage pour pieds | | | | | |
|  |  4 009463 202729 | 47 0120 69 | mit 1x3 Holzrollen avec 1x3 rouleaux en bois 16.5 x 12.5 x 5 cm | 1 |  | 16.96 | 18.27 |
| Fussmassageroller | | Rouleau de massage pour pieds | | | | | |
|  |  4 009463 202736 | 47 0120 70 | mit 2x4 Rollen avec 2x4 rouleaux 23 x 18 x 5 cm | 1 |  | 42.87 | 46.17 |
| Massagehandroller gross | | Rouleau de massage grand | | | | | |
|  |  4 009463 202750 | 47 0120 45 | 15.5 x 11.5 x 7 cm | 1 |  | 12.77 | 13.75 |
| Sauna-Aufgusskübel | | Seau sauna | | | | | |
|  |  4 009463 135003 | 47 0120 76 | Kiefer pin Ø 26.5 x 17 cm | 1 |  | 80.15 | 86.32 |



ACCESSOIRES - Croll & Denecke

| | EAN-Nr. no EAN | Artikel Nr. no d'article | Beschreibung description | VPE ce | VE ue | UVP pro Stk. PVC CHF excl. | UVP pro Stk. PVC CHF incl. |
|--|-------------------|-----------------------------|-----------------------------|-----------|----------|----------------------------------|----------------------------------|
|--|-------------------|-----------------------------|-----------------------------|-----------|----------|----------------------------------|----------------------------------|

Sauna-Aufgusskelle

Cuillère sauna





| | | | | | | |
|--|-------------------|--------------------------|---|---|--------------|--------------|
|  4 009463 135010 | 47 0120 75 | Kiefer pin 42.5 cm | 1 |  | 21.43 | 23.09 |
|--|-------------------|--------------------------|---|---|--------------|--------------|

Massageball gross

Balle de massage grand





| | | | | | | |
|--|-------------------|--|---|---|-------------|-------------|
|  4 009463 601003 | 47 0120 82 | weiss transparent blanc transparent Ø 8 cm | 1 |  | 5.96 | 6.42 |
|--|-------------------|--|---|---|-------------|-------------|

Tüllschwamm

Eponge fleur



| | | | | | | |
|--|-------------------|------------------------------|---|---|-------------|-------------|
|  4 009463 205003 | 47 0120 46 | farbig assortiert assorti | 1 |  | 3.17 | 3.41 |
|--|-------------------|------------------------------|---|---|-------------|-------------|

















ACCESSOIRES - Croll & Denecke

| EAN-Nr. no EAN | Artikel Nr. no d'article | Beschreibung description | VPE ce | VE ue | UVP pro Stk. PVC CHF excl. | UVP pro Stk. PVC CHF incl. |
|-------------------|-----------------------------|-----------------------------|-----------|----------|----------------------------------|----------------------------------|
|-------------------|-----------------------------|-----------------------------|-----------|----------|----------------------------------|----------------------------------|

Peelinghandschuhe

Gants de gommage





| | | | | | | |
|--|-------------------|--|---|---|-------------|-------------|
|  | 47 0124 04 | green - Set à 2 Stk. green - set à 2 pièces | 1 |  | 7.27 | 7.83 |
|  | 47 0124 11 | orange - Set à 2 Stk. orange - set à 2 pièces | 1 |  | 7.27 | 7.83 |
|  | 47 0124 41 | weiss - Set à 2 Stk. blanc - set à 2 pièces | 1 |  | 7.27 | 7.83 |
|  | 47 0124 53 | pink - Set à 2 Stk. pink - set à 2 pièces | 1 |  | 7.27 | 7.83 |
|  | 47 0124 56 | blue - Set à 2 Stk. blue - set à 2 pièces | 1 |  | 7.27 | 7.83 |
|  | 47 0124 58 | gray - Set à 2 Stk. gray - set à 2 pièces | 1 |  | 7.27 | 7.83 |
|  | 47 0124 70 | yellow - Set à 2 Stk. yellow - set à 2 pièces | 1 |  | 7.27 | 7.83 |



Wellnessset im Holzbottich

Set wellness dans baquet bois



| | | | | | | |
|---|-------------------|--------------|---|---|--------------|--------------|
|  | 47 0120 39 | Ø 16 x 15 cm | 1 |  | 29.82 | 32.12 |
|---|-------------------|--------------|---|---|--------------|--------------|

Inhalt:

- Sisal-Frottéschwamm
- Nagelbürste
- Tüllschwamm
- Bimsstein
- Handroller
- Haarbürste

Contenu:

- Éponge Sisal/Frotté
- Brosse à ongles
- Éponge fleur
- Pierre ponce
- Rouleau de massage
- Brosse à cheveux



ACCESSOIRES - Croll & Denecke

| | EAN-Nr. <i>no EAN</i> | Artikel Nr. <i>no d'article</i> | Beschreibung <i>description</i> | VPE <i>ce</i> | VE <i>ue</i> | UVP pro Stk. <i>PVC</i> CHF excl. | UVP pro Stk. <i>PVC</i> CHF incl. |
|--|--------------------------|------------------------------------|------------------------------------|------------------|-----------------|---|---|
|--|--------------------------|------------------------------------|------------------------------------|------------------|-----------------|---|---|

Wellnessset im Bambusbottich

Set wellness baquet bambou



| | | | | | | |
|---|-------------------|--------------|---|---|--------------|--------------|
|  | 47 0120 40 | Ø 16 x 15 cm | 1 |  | 33.08 | 35.63 |
|---|-------------------|--------------|---|---|--------------|--------------|

Inhalt:

- Tüllschwamm
- Badebürste
- Nagelbürste aus Bambusholz
- dunkler Bimsstein
- Massagehandschuh aus Baumwolle

Contenu:

- Éponge fleur
- Brosse de bain
- Brosse à ongles en bois bambou
- Pierre ponce sombre
- Gant de massage en coton



OWL you need
is **LOVE**





WC-Sitze

Sièges de WC

Kapitel 5 - Inhaltsverzeichnis

Chapitre 5 - Sommaire

| | |
|---|------|
| Polypropylen <i>Polypropylène</i> | 5.8 |
| Duroplast <i>Plastique dur</i> | 5.22 |
| Wood <i>Wood</i> | 5.52 |
| Polypropylen, mit Motiv <i>Polypropylène, avec motif</i> | 5.61 |
| Duroplast, mit Motiv <i>Plastique dur, avec motif</i> | 5.67 |
| Wood, mit Motiv <i>Wood, avec motif</i> | 5.97 |



Erklärung der Piktogramme *Explications des pictogrammes*



Strong Fix

WC-Sitz mit Metallbefestigung für einen dauerhaften und festen Halt

Siège de WC à renfort métallique pour plus de durabilité et de solidité



Fast to Fix

WC-Sitz mit Schnellbefestigung

Siège de WC à fixation rapide



Easy Cleaning

WC-Sitz mit einfacher Reinigungsmöglichkeit

Siège de WC à nettoyage simplifié



Easy Cleaning Push

WC-Sitz per Knopfdruck zum Reinigen abnehmbar

Démontage aisé du siège de WC pour nettoyage en appuyant sur un bouton



Anti-Bacterial

WC-Sitz mit minimaler Verkeimung

Siège de WC à faible risque de contamination



Wash and Clean

WC-Sitz mit Duschfunktion

Siège de WC avec fonction de douche



FSC®-zertifizierte Produkte hergestellt aus Holz aus Wäldern mit verantwortungsbewusster Waldwirtschaft

Produits certifiés FSC®, fabriqués à partir de bois provenant de forêts gérées de manière responsable



Shiny

WC-Sitz mit Brillanz-Effekt

Siège de WC avec effet brillant



3D

WC-Sitz mit 3D-Effekt

Siège de WC avec effet de 3D



Relief

WC-Sitz mit Relief-Oberfläche

Siège de WC avec surface en relief



Slow Down

WC-Sitz mit Absenkautomatik für mehr Ruhe

Siège de WC à abaissement automatique pour plus de silence



LED

WC-Sitz mit integrierter LED-Funktion

Siège de WC avec fonction LED intégrée



Recycling

Hergestellt aus recyceltem Material

Fabriqués à partir de matériaux recyclés













Made in Europe

In Europa hergestellt

Fabriqués en Europe

Funktionen WC-Sitz

Fonctions siège de WC

| Modell/ Model | Material/ Matériel | TopFix BVO* | Light LED | FastFix  | Strong Fix  | Easy Cleaning  | Easy Cleaning PUSH  | Anti-Bac  | WASH and CLEAN  | Shiny  | 3D  | Relief  | Slow Down  |  |
|-----------------------|-----------------------|----------------|--------------|--|---|--|--|--|--|--|---|---|--|---|
| Avignon | Duroplast | | | | x | x | | | | | | | x | |
| Barbana | Duroplast | {x} | | | x | | x | | | | | | x | |
| Brest | Duroplast | | | | x | | x | x | | | | | x | |
| Clichy | Duroplast | | | | x | | x | | | | | | x | |
| Comfort | Duroplast | | | | x | | | x | | | | | x | |
| ComfortPlus | Duroplast | | | | | | | | | | | | x | |
| Dijon | Duroplast | | | | x | | x | | | | | | x | |
| Derval | Duroplast | | | | x | | | | | | | | x | |
| Evia | Duroplast | | | | x | x | | | | | | | x | |
| Formica | Duroplast | | | | x | x | | | | | | | x | |
| Hollywood | Duroplast | | | | x | x | | | | | | | x | |
| Laval | Duroplast | | | x | | x | | | | | | | x | |
| Lavalino | Duroplast | | | | x | | x | | x | | | | x | |
| Lille | Duroplast | | | | x | | x | | | | | | x | |
| Malaga | Duroplast | | | x | | | | | | | | | | |
| Martano | Duroplast | | | | x | | x | | | | | | x | |
| Move | Duroplast | | | x | | | | | | | | | | |
| Nancy | Duroplast | | | | x | | x | | | | | | x | |
| Nice | Duroplast | | | | x | | x | | | | | | x | |
| Perth | Duroplast | | x | | x | | x | | | | | | x | |
| Pike | Duroplast | | | x | | x | | | | | | | x | |
| Plain | Duroplast | | | | x | | x | | | | | | x | |
| Race | Duroplast | | | | x | | x | | | | | | x | |
| Rennes | Duroplast | | | | | | | | | | | | x | |
| Rouen | Duroplast | | | | x | x | | | | | | | x | |
| Sidney | Duroplast | | x | | x | | x | | | | | | x | |
| Toulon | Duroplast | | | | x | | x | | | | | | x | |
| Verona | Duroplast | | | x | | | | | | | | | | |
| Vienna | Duroplast | | | | x | | x | | | | | | x | |
| Lyon Dark Bamboo | Massivholz | | | | x | | | | | | | | x | |
| Brillant | MDF | | | | x | | | | | x | | | x | 100% |
| Forest | MDF | | | | x | | | | | | | | x | 100% |
| KAN 2001 | MDF | | | | | x | | | | | | | | MIX |
| Lyon | MDF | | | | x | | | | | | | | x | 100% |
| Madrid | MDF | | | | x | | | | | | | | x | 100% |
| Mobello | MDF | x | | | | | | | | | | | | |
| Paris 3D | MDF | | | | x | | | | | | x | | x | 100% |
| Arles | Polypropylen | x | | | | x | | | | | | | x | |
| Arolla Lux | Polypropylen | x | | | | | | | | | | | | |
| Medico Festscharnier | Polypropylen | | | | | | | | | | | | | |
| Medico Steckscharnier | Polypropylen | | | | | x | | | | | | | | |
| Metz | Polypropylen | | | | x | | x | | | | | | x | |
| Neolux® | Polypropylen | | | | | x | | | | | | | | |
| Neosit® | Polypropylen | | | | | x | | | | | | | | |
| Neosit® Prestige | Polypropylen | | | | | x | | | | | | | | |
| O'3000 | Polypropylen | | | | | x | | | | | | | | |
| Perca | Polypropylen | | | x | | x | | | | | | | x | |
| Ravenna | Polypropylen | | | | x | x | | | | | | | x | |
| Salvador | Polypropylen | | | | x | | x | | | | | | x | |
| Spotline | Polypropylen | | | | | x | | | | | | | | |
| Tino | Polypropylen | | | | x | | x | | | | | | x | |

* x = BVO (Befestigung von oben) standard / Fixation par dessus standard

{x} = BVO (Befestigung von oben) optional / Fixation par dessus en option



WC-Sitze Sièges de WC

Polypropylen Polypropylène



Besonders elastisches Material, welches dadurch sehr belastbar und bruchstabil ist. Überträgt die eigene Körperwärme schnell.

Matériau particulièrement élastique, ce qui le rend très résistant à la charge et à la rupture. Transmet rapidement la propre chaleur du corps.

Duroplast Plastique dur



WC-Sitze aus extrem harten und robustem Material, die gegen Kratzer sowie UV-Strahlen resistent sind. Verliert selbst nach jahrelangem Gebrauch nichts von seiner Strahlkraft.

Sièges WC en matériau extrêmement dur et robuste, résistant aux rayures ainsi qu'aux rayons UV. Ne perd rien de son éclat, même après des années d'utilisation.

Holz Bois



Die Sitze aus Holzfasertafeln (MDF) bieten eine bequeme und warme Sitzfläche. Die meisten WC-Sitze aus Holz sind FSC®-zertifiziert.

Les abattants en panneaux de fibres de bois (MDF) offrent une assise confortable et chaleureuse. La plupart des abattants de WC en bois sont certifiés FSC®.

Mit Duschfunktion Avec fonction douche



Der WC-Sitz Lavalino hat eine eingebaute Duschfunktion für die Hygiene des Intimbereichs.

Le siège de WC Lavalino a une fonction de douche intégrée pour l'hygiène des parties intimes.

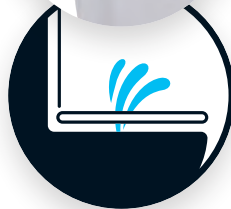

Mit LED Avec LED



Mittels eines Audiosensors und nur bei Dunkelheit wird die LED-Funktion des WC-Sitzes Menton eingeschaltet. Ohne Geräusche erlischt das LED-Licht nach wenigen Minuten automatisch.

La fonction LED du siège de WC Menton s'allume au moyen d'un capteur audio et uniquement dans l'obscurité. Sans aucun bruit, la lumière LED s'éteint automatiquement après quelques minutes.



WC-Sitz Comfort Siège WC Comfort

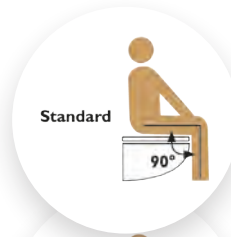

Standard

90°



COMFORT

+5 cm

98°

Für höchste Ansprüche an Komfort und Hygiene. Dank der erhöhten Sitzposition von 5 cm kann man sich bequem hinsetzen und aufstehen.

Pour répondre aux exigences les plus élevées en matière de confort et d'hygiène. Grâce à la position d'assise surélevée de 5 cm, on peut s'asseoir et se lever facilement.

Polypropylen - Arolla Lux

| EAN-Nr. <i>no EAN</i> | Artikel Nr. <i>no d'article</i> | Beschreibung <i>description</i> | VPE <i>ce</i> | VE <i>ue</i> | UVP pro Stk. <i>PVC</i> CHF excl. | UVP pro Stk. <i>PVC</i> CHF incl. |
|--------------------------|------------------------------------|------------------------------------|------------------|-----------------|---|---|
|--------------------------|------------------------------------|------------------------------------|------------------|-----------------|---|---|

| | |
|---------------------------|-------------------------------|
| WC-Sitz Arolla Lux | Siège de WC Arolla Lux |
|---------------------------|-------------------------------|



31 1936 41

alpinweiss
blanc alpin
43.5 x 37 cm

5



130.47

140.52

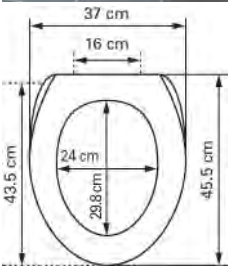

aus Polypropylen
steckbar / verstellbar
en polypropylène
enfichable / ajustable

| | |
|-----------------------------|------------------------|
| Befestigungsgarnitur | Jeu de fixation |
|-----------------------------|------------------------|



31 1930 30

alpinweiss
blanc alpin

1



29.82

32.12

| | |
|------------------|--------------------|
| Pufferset | Set butoirs |
|------------------|--------------------|



31 1930 09

alpinweiss
blanc alpin

1



8.71



9.38

2 Sitzpuffer
2 butoirs pour lunette

Polypropylen - Medico

| EAN-Nr. no EAN | Artikel Nr. no d'article | Beschreibung description | VPE ce | VE ue | UVP pro Stk. PVC CHF excl. | UVP pro Stk. PVC CHF incl. |
|-------------------|-----------------------------|-----------------------------|-----------|----------|----------------------------------|----------------------------------|
|-------------------|-----------------------------|-----------------------------|-----------|----------|----------------------------------|----------------------------------|

| | |
|---------------------------------------|------------------------------|
| WC-Ringsitz Medico Festscharn. | Lunette WC Medico fix |
|---------------------------------------|------------------------------|

| | | | | | | | |
|---|--|-------------------|---|----|---|--------------|--------------|
|  |  7 611038 011178 | 31 1940 41 | edelweiss blanc edelweiss 42.5-44.5 x 38.5 cm | 5 |  | 51.26 | 55.20 |
| |  7 611038 011185 | 31 1940 46 | beige 42.5-44.5 x 38.5 cm | 10 |  | 51.26 | 55.20 |

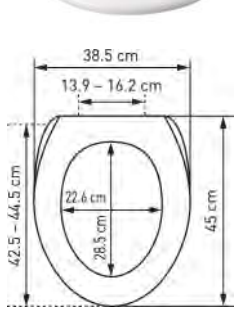

Hitzebeständig bis ca. 130 °C
 Resiste à la chaleur
 jusqu'à env. 130 °C

| | |
|----------------------|-----------------------|
| Festscharnier | Charnières fix |
|----------------------|-----------------------|





| | | | | | | | |
|---|--|-------------------|------------------------------|---|---|--------------|--------------|
|  |  7 611038 011239 | 31 1930 62 | edelweiss blanc edelweiss | 1 |  | 20.50 | 22.08 |
| |  7 611038 011222 | 31 1930 63 | beige | 1 |  | 20.50 | 22.08 |

zu Medico Festscharnier
 pour Medico fix

Polypropylen - Medico

| EAN-Nr. no EAN | Artikel Nr. no d'article | Beschreibung description | VPE ce | VE ue | UVP pro Stk. PVC CHF excl. | UVP pro Stk. PVC CHF incl. |
|-------------------|-----------------------------|-----------------------------|-----------|----------|----------------------------------|----------------------------------|
|-------------------|-----------------------------|-----------------------------|-----------|----------|----------------------------------|----------------------------------|

| WC-Ringsitz Medico Steckscharn | Lunette WC Medico enfichable |
|--------------------------------|------------------------------|
|--------------------------------|------------------------------|

| | | | | | | | |
|---|---|-------------------|---|----|---|--------------|--------------|
|  |  | 32 3010 41 | edelweiss blanc edelweiss 42.5-44.5 x 38.5 cm | 10 |  | 67.10 | 72.27 |
| |  | 32 3010 46 | beige 42.5-44.5 x 38.5 cm | 10 |  | 67.10 | 72.27 |

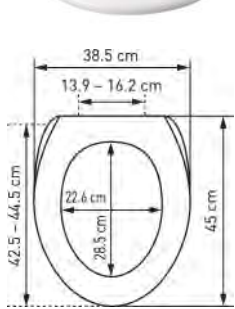

Hitzebeständig bis ca. 130 °C
Resiste à la chaleur
jusqu'à env. 130 °C

| Steckscharnier | Charnière enfichable |
|----------------|----------------------|
|----------------|----------------------|



| | | | | | | | |
|---|---|-------------------|------------------------------|---|---|--------------|--------------|
|  |  | 32 3015 96 | edelweiss blanc edelweiss | 1 |  | 19.57 | 21.08 |
| |  | 32 3016 96 | beige | 1 |  | 19.57 | 21.08 |

zu Medico Steckscharnier
pour Medico enfichable

Polypropylen - NEOLUX®

| | EAN-Nr. <i>no EAN</i> | Artikel Nr. <i>no d'article</i> | Beschreibung <i>description</i> | VPE <i>ce</i> | VE <i>ue</i> | UVP pro Stk. <i>PVC</i> CHF excl. | UVP pro Stk. <i>PVC</i> CHF incl. |
|--|--------------------------|------------------------------------|------------------------------------|------------------|-----------------|---|---|
|--|--------------------------|------------------------------------|------------------------------------|------------------|-----------------|---|---|

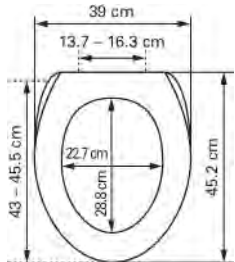

WC-Sitz Neolux® Siège de WC Neolux®

| | | | | | | | |
|---|--|-------------------|--|---|---|--------------|--------------|
|  |  7 610955 036714 | 30 3000 41 | edelweiss <i>blanc (edelweiss)</i> 43-44.5 x 39 cm | 5 |  | 53.12 | 57.21 |
|---|--|-------------------|--|---|---|--------------|--------------|





aus Polypropylen
en polypropylène

Befestigungsgarnitur Jeu de fixation

| | | | | | | | |
|--|---|-------------------|--|---|--|--------------|--------------|
|  |  7 611038 300067 | 30 2241 98 | edelweiss <i>blanc edelweiss</i> 5 | 2 |  | 21.43 | 23.09 |
|--|---|-------------------|--|---|--|--------------|--------------|

Polypropylen - O'3000

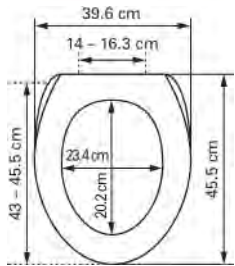

| EAN-Nr. <i>no EAN</i> | Artikel Nr. <i>no d'article</i> | Beschreibung <i>description</i> | VPE <i>ce</i> | VE <i>ue</i> | UVP pro Stk. <i>PVC</i> CHF excl. | UVP pro Stk. <i>PVC</i> CHF incl. |
|--------------------------|------------------------------------|------------------------------------|------------------|-----------------|---|---|
|--------------------------|------------------------------------|------------------------------------|------------------|-----------------|---|---|

| WC-Sitz O'3000 | | Siège de WC O'3000 | | | | | |
|---|---|--------------------|---|---|---|-------|-------|
|  |  | 31 1931 41 | alpinweiss <i>blanc alpin</i> 43-45.5 x 39.6 cm | 5 |  | 47.53 | 51.19 |
| | | | | | | | |





aus Polypropylen
Passend zu Stand-WC Pascha
von Laufon oder ähnliche
Typen. Nicht geeignet für
Laufon Moderna resp. für
hinten breiter geformte
WC-Typen.

en polypropylène
S'adapte au modèle Pascha de
Laufon ou type similaire.
Ne convient pas sur le type
Moderna de Laufon et sur les
types de cuvettes élargie
à l'arrière.

| Befestigungsgarnitur | | Jeu de fixation | | | | | |
|---|---|-----------------|----------------------------------|---|---|-------|-------|
|  |  | 31 1930 83 | alpinweiss <i>blanc alpin</i> | 1 |  | 19.57 | 21.08 |
| | | | | | | | |





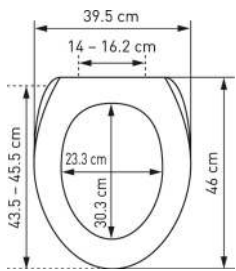

Polypropylen - NEOSIT®

| EAN-Nr. <i>no EAN</i> | Artikel Nr. <i>no d'article</i> | Beschreibung <i>description</i> | VPE <i>ce</i> | VE <i>ue</i> | UVP pro Stk. <i>PVC</i> CHF excl. | UVP pro Stk. <i>PVC</i> CHF incl. |
|--------------------------|------------------------------------|------------------------------------|------------------|-----------------|---|---|
|--------------------------|------------------------------------|------------------------------------|------------------|-----------------|---|---|

| WC-Sitz Neosit® | | Siège de WC Neosit® | | | | | |
|---|--|---------------------|--|----|---|--------------|--------------|
|  |  7 610955 013005 | 30 1000 41 | edelweiss <i>blanc (edelweiss)</i> 43.5-45.5 x 39.5 cm | 10 |  | 42.40 | 45.67 |



aus Polypropylen
kompatibel zu Sanaform Lux
en polypropylène
compatible au Sanaform Lux

| Befestigungsgarnitur | | Jeu de fixation | | | | | |
|---|--|-------------------|--|---|---|--------------|--------------|
|  |  7 611038 300067 | 30 2241 98 | edelweiss <i>blanc edelweiss</i> 5 | 2 |  | 21.43 | 23.09 |
|  |  7 611038 300012 | 30 2246 98 | beige 5 | 2 |  | 21.43 | 23.09 |

Polypropylen - NEOSIT® Prestige

| EAN-Nr. <i>no EAN</i> | Artikel Nr. <i>no d'article</i> | Beschreibung <i>description</i> | VPE <i>ce</i> | VE <i>ue</i> | UVP pro Stk. <i>PVC</i> CHF excl. | UVP pro Stk. <i>PVC</i> CHF incl. |
|--------------------------|------------------------------------|------------------------------------|------------------|-----------------|---|---|
|--------------------------|------------------------------------|------------------------------------|------------------|-----------------|---|---|

WC-Sitz Neosit® Prestige

Siège de WC Neosit® Prestige



aus Polypropylen
kompatibel zu Sanaform Lux
en polypropylène
compatible au Sanaform Lux

| | | | | | | |
|--|-------------------|--|---|--|--------------|--------------|
| | 30 1201 41 | edelweiss <i>blanc edelweiss</i> 43-44.5 x 38.5 cm ; 7 | 7 | | 32.15 | 34.63 |
| | 30 1201 46 | beige 43-44.5 x 38.5 cm | 7 | | 32.15 | 34.63 |
| | 30 1201 78 | marineblau <i>bleu marine</i> 43-44.5 x 38.5 cm | 7 | | 31.22 | 33.62 |
| | 30 1201 08 | granit 43-44.5 x 38.5 cm | 1 | | 32.15 | 34.63 |



Befestigungsgarnitur



Jeu de fixation



| | | | | | | |
|--|-------------------|--|---|--|--------------|--------------|
| | 31 1950 98 | edelweiss <i>blanc edelweiss</i> 7 | 2 | | 22.83 | 24.59 |
|--|-------------------|--|---|--|--------------|--------------|



Polypropylen - Spotline

| EAN-Nr. no EAN | Artikel Nr. no d'article | Beschreibung description | VPE ce | VE ue | UVP pro Stk. PVC CHF excl. | UVP pro Stk. PVC CHF incl. |
|-------------------|-----------------------------|-----------------------------|-----------|----------|----------------------------------|----------------------------------|
|-------------------|-----------------------------|-----------------------------|-----------|----------|----------------------------------|----------------------------------|

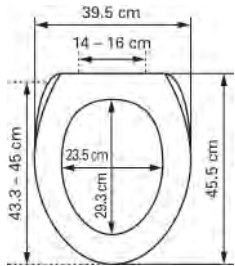
| WC-Sitz Spotline | | Siège de WC Spotline | | | | | |
|---|--|----------------------|---|---|---|--------------|--------------|
|  |  7 611038 180584 | 49 6302 41 | edelweiss blanc (edelweiss) 43.3-45 x 39.5 cm ; 5 | 7 |  | 26.56 | 28.61 |



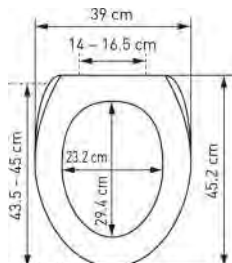

aus Polypropylen
en polypropylène

| Kinder WC-Sitz | | Siège de WC pour enfant | | | | | |
|--|---|-------------------------|---|---|--|--------------|--------------|
|  |  7 611038 052102 | 30 4000 98 | edelweiss blanc edelweiss 43.5-45 x 39 cm | 8 |  | 61.51 | 66.25 |



aus Polypropylen
en polypropylène



| Befestigungsgarnitur | | Jeu de fixation | | | | | |
|---|--|-------------------|-----------------------------------|---|---|--------------|--------------|
|  |  7 611038 300067 | 30 2241 98 | edelweiss blanc edelweiss 5 | 2 |  | 21.43 | 23.09 |

Polypropylen - Spotline

| EAN-Nr. <i>no EAN</i> | Artikel Nr. <i>no d'article</i> | Beschreibung <i>description</i> | VPE <i>ce</i> | VE <i>ue</i> | UVP pro Stk. <i>PVC</i> CHF excl. | UVP pro Stk. <i>PVC</i> CHF incl. |
|--------------------------|------------------------------------|------------------------------------|------------------|-----------------|---|---|
|--------------------------|------------------------------------|------------------------------------|------------------|-----------------|---|---|

WC-Sitz Baby-Soft

Siège de WC Baby-Soft

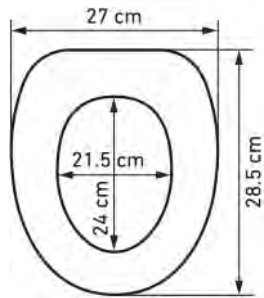

| | | | | | | |
|--|-------------------|-------------------------------------|----|---|--------------|--------------|
|  7 611038 073091 | 31 6116 90 | bunt <i>coloré</i> 29 x 28 cm | 12 |  | 33.55 | 36.13 |
|--|-------------------|-------------------------------------|----|---|--------------|--------------|



mit Spritzschutz
avec protection contre les éclaboussures



Polypropylen - Tino

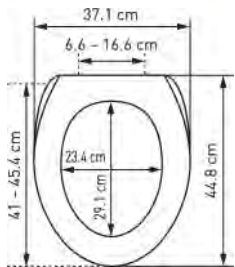

| EAN-Nr. no EAN | Artikel Nr. no d'article | Beschreibung description | VPE ce | VE ue | UVP pro Stk. PVC CHF excl. | UVP pro Stk. PVC CHF incl. |
|-------------------|-----------------------------|-----------------------------|-----------|----------|----------------------------------|----------------------------------|
|-------------------|-----------------------------|-----------------------------|-----------|----------|----------------------------------|----------------------------------|

| Family WC-Sitz Tino Slow Down | | Siège WC Family Tino Slow Down | | | | | |
|---|--|--------------------------------|--|---|---|--------------|--------------|
|  |  7 611038 182298 | 31 1608 41 | weiss blanc 41-45.4 x 37.1 cm ; 33 | 5 |  | 34.48 | 37.14 |



- WC-Sitz für Gross und Klein!
 - Normaler WC-Ring für Erwachsene mit spezieller Einlage für Kinder
 - mit Magnet am Deckel- somit kein lästiges Zurückfallen der Kindersitzeinlage
 - Kindersitzeinlage abnehmbar
Un siège de WC pour les petits et les grands!
 - Lunette de WC normale pour adultes avec insert spécial pour enfants
 - Couvercle à aimants permettant d'éviter que le siège enfant ne retombe inopportunément
 - Insert siège enfant démontable



| Befestigungsgarnitur ab 2020 | | Jeu de fixation dès 2020 | | | | | |
|---|--|--------------------------|----|---|---|--------------|--------------|
|  |  7 611038 691899 | 31 1670 98 | 33 | 2 |  | 18.08 | 19.47 |

| Pufferset | | Set butoirs | | | | | |
|---|--|-------------------|----------------------|---|---|--|--|
|  |  7 611038 162603 | 31 1689 96 | weiss blanc 14 | 1 |  | | |

- 2 Deckelpuffer & 4 Sitzpuffer
 2 butoirs pour couvercle &
 4 butoirs pour lunette



Polypropylen - Metz

| EAN-Nr. no EAN | Artikel Nr. no d'article | Beschreibung description | VPE ce | VE ue | UVP pro Stk. PVC CHF excl. | UVP pro Stk. PVC CHF incl. |
|-------------------|-----------------------------|-----------------------------|-----------|----------|----------------------------------|----------------------------------|
|-------------------|-----------------------------|-----------------------------|-----------|----------|----------------------------------|----------------------------------|

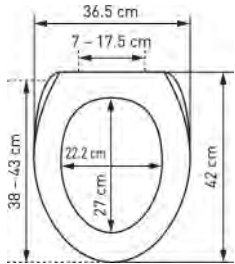
| WC-Sitz Metz Slow Down | | Siège de WC Metz Slow Down | | | | |
|---|--|----------------------------|--|---|---|---------------------------|
|  |  7 611038 099893 | 31 1639 41 | weiss blanc 38-43 x 36.5 cm ; 36 | 5 |  | 52.19 56.21 |





aus Polypropylen
mit Absenkautomatik
en polypropylène
abaissement automatique

| Ringpuffer | | Butoirs pour couvercle | | | | |
|---|--|------------------------|--------------------|---|---|-------------------------|
|  |  7 611038 136628 | 31 1639 96 | grau gris 36 | 1 |  | 8.15 8.78 |

4 Sitzpuffer
4 butoirs pour lunette



Polypropylen - Perca

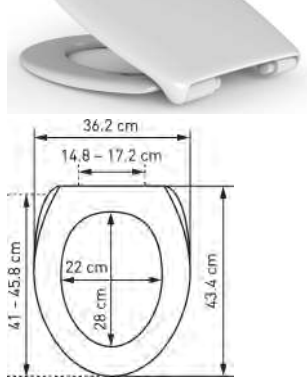

| EAN-Nr. <i>no EAN</i> | Artikel Nr. <i>no d'article</i> | Beschreibung <i>description</i> | VPE <i>ce</i> | VE <i>ue</i> | UVP pro Stk. <i>PVC</i> CHF excl. | UVP pro Stk. <i>PVC</i> CHF incl. |
|--------------------------|------------------------------------|------------------------------------|------------------|-----------------|---|---|
|--------------------------|------------------------------------|------------------------------------|------------------|-----------------|---|---|

| WC-Sitz Perca Slow Down | | Siège de WC Perca Slow Down | | | | | |
|---|--|-----------------------------|---|---|---|--------------|--------------|
|  |  7 611038 166540 | 31 1640 41 | weiss <i>blanc</i> 41-45.8 x 36.2 cm ; 29 | 7 |  | 45.67 | 49.18 |



aus Polypropylen
mit Absenkautomatik
en polypropylène
abaissement automatique

| Excenterscharnier Eco | | Charnière excentrique Eco | | | | | |
|---|--|---------------------------|-------------|---|---|--------------|--------------|
|  |  4 016959 129156 | 31 1640 96 | Nylon 29 | 1 |  | 24.70 | 26.60 |

| Pufferset | | Set butoirs | | | | | |
|---|--|-------------------|-----------------------|---|---|--------------|--------------|
|  |  7 611038 166786 | 31 1640 94 | weiss <i>blanc</i> | 1 |  | 12.30 | 13.25 |

4 Sitzpuffer
4 butoirs pour lunette

Polypropylen - Ravenna

| EAN-Nr. no EAN | Artikel Nr. no d'article | Beschreibung description | VPE ce | VE ue | UVP pro Stk. PVC CHF excl. | UVP pro Stk. PVC CHF incl. |
|-------------------|-----------------------------|-----------------------------|-----------|----------|----------------------------------|----------------------------------|
|-------------------|-----------------------------|-----------------------------|-----------|----------|----------------------------------|----------------------------------|

NEW

WC-Sitz Ravenna Slow Down

Siège de WC Ravenna Slow Down



31 1685 41

Recyclat - weiss
Recyclé - blanc
41 - 46 x 36.5 cm ; 29

7



46.55

50.14



100% recyceltes
Polypropylen
100% polypropylène recyclé

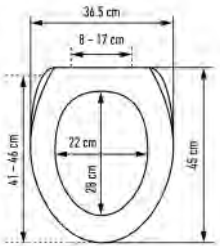

aus Polypropylen
mit Absenkautomatik
en polypropylène
abaissement automatique

Excenterscharnier Eco

Charnière excentrique Eco



31 1640 98

Nylon
29

3





25.16

27.10



Polypropylen - Salvador

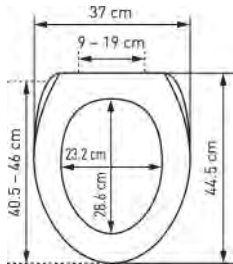

| EAN-Nr. no EAN | Artikel Nr. no d'article | Beschreibung description | VPE ce | VE ue | UVP pro Stk. PVC CHF excl. | UVP pro Stk. PVC CHF incl. |
|-------------------|-----------------------------|-----------------------------|-----------|----------|----------------------------------|----------------------------------|
|-------------------|-----------------------------|-----------------------------|-----------|----------|----------------------------------|----------------------------------|

| WC-Sitz Salvador Slow Down | | Siège de WC Salvador Slow Down | | | | | |
|---|--|--------------------------------|--|---|---|-------|-------|
|  |  7 611038 142513 | 31 1600 41 | weiss blanc 40.5-46 x 37 cm ; 28 | 5 |  | 34.48 | 37.14 |



aus Polypropylen
mit Absenkautomatik
en polypropylène
abaissement automatique



| Befestigungsgarnitur | | Jeu de fixation | | | | | |
|---|--|-----------------|----|---|---|-------|-------|
|  |  7 611038 142537 | 31 1600 94 | 28 | 1 |  | 26.09 | 28.10 |

| Pufferset | | Set butoirs | | | | | |
|---|--|-------------|----------------------|---|---|-------|-------|
|  |  7 611038 142520 | 31 1600 96 | weiss blanc 28 | 1 |  | 11.84 | 12.75 |

2 Deckelpuffer & 4 Sitzpuffer
2 butoirs pour couvercle &
4 butoirs pour lunette

Duroplast - Lavalino

| EAN-Nr. <i>no EAN</i> | Artikel Nr. <i>no d'article</i> | Beschreibung <i>description</i> | VPE <i>ce</i> | VE <i>ue</i> | UVP pro Stk. <i>PVC CHF excl.</i> | UVP pro Stk. <i>PVC CHF incl.</i> |
|--------------------------|------------------------------------|------------------------------------|------------------|-----------------|--|--|
|--------------------------|------------------------------------|------------------------------------|------------------|-----------------|--|--|

| WC-Sitz Lavalino Slow Down | | Siège de WC Lavalino Slow Down | | | | |
|---|-------------------|--|---|---|---------------|---------------|
|  | 31 1696 41 | weiss / mit Duschfunktion <i>blanc / avec fonction de douche</i> 42.5 - 44.5 x 37 cm | 3 |  | 273.99 | 295.09 |

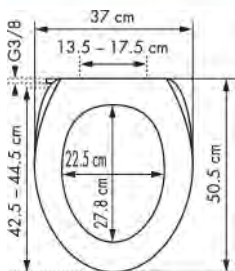

aus Duroplast
mit Absenkautomatik
*en plastique dur
abaissement automatique*



- WC-Sitz mit Duschfunktion WASH and CLEAN für den Intimbereich
 - Regelbarer Wasserstrahl (Kaltwasseranschluss)
 - Kein Stromanschluss erforderlich
 - Passt auf alle handelsüblichen WC-Anlagen
 - Erfüllt höchste Hygieneansprüche nach DIN EN 1717, KTW-A und W270 geprüft
 - Bewährte Komponenten von führenden Herstellern (Düse, Absicherung und Ventil)
 - inkl. T-Stück 3/8" zur Wasserentnahme am Eckventil
- Siège de WC avec fonction de nettoyage WASH and CLEAN pour les zones intimes
 - Jet d'eau réglable (eau froide)
 - Compatible avec toutes les installations de WC disponible sur le marché
 - Satisfait aux plus hautes exigences en matière d'hygiène selon la norme DIN EN 1717, certifié KTW-A & W270
 - Composants éprouvés par les grands fabricants (buse, sécurité, vanne)
 - Incl. pièce en T 3/8" pour la prise d'eau sur la vanne coudée

| Wasseranschlusset | | Set de raccordement d'eau | | | | |
|---|-------------------|--------------------------------------|---|---|---------------|---------------|
|  | 58 3560 96 | für Lavalino <i>pour Lavalino</i> | 1 |  | 190.12 | 204.76 |



Duroplast - Lavalino

| EAN-Nr. <i>no EAN</i> | Artikel Nr. <i>no d'article</i> | Beschreibung <i>description</i> | VPE <i>ce</i> | VE <i>ue</i> | UVP pro Stk. <i>PVC</i> CHF excl. | UVP pro Stk. <i>PVC</i> CHF incl. |
|--------------------------|------------------------------------|------------------------------------|------------------|-----------------|---|---|
|--------------------------|------------------------------------|------------------------------------|------------------|-----------------|---|---|

| | |
|-----------------------------|------------------------|
| Befestigungsgarnitur | Jeu de fixation |
|-----------------------------|------------------------|



| | | | | | | |
|--|-------------------|--|---|---|--------------|--------------|
|  7 611038 161217 | 31 1696 94 | | 1 |  | 19.57 | 21.08 |
|--|-------------------|--|---|---|--------------|--------------|

| | |
|--------------------------------------|----------------------------|
| Befestigungsgarnitur von oben | Fixation par dessus |
|--------------------------------------|----------------------------|



| | | | | | | |
|--|-------------------|-----|---|---|--------------|--------------|
|  7 611038 161262 | 31 1696 95 | BVO | 1 |  | 19.11 | 20.58 |
|--|-------------------|-----|---|---|--------------|--------------|

| | |
|------------------|-------------------------------|
| Pufferset | Set butoir de rechange |
|------------------|-------------------------------|



| | | | | | | |
|--|-------------------|---------------------|---|---|--------------|--------------|
|  7 611038 161200 | 31 1696 96 | grau <i>gris</i> | 1 |  | 11.18 | 12.04 |
|--|-------------------|---------------------|---|---|--------------|--------------|

2 Deckpuffer & 4 Sitzpuffer
 2 *butoirs pour couvercle* &
 4 *butoirs pour lunette*



WC-Sitz ComfortPlus Slow Down

ComfortPlus Slow Down

| EAN-Nr. no EAN | Artikel Nr. no d'article | Beschreibung description | VPE ce | VE ue | UVP pro Stk. PVC CHF excl. | UVP pro Stk. PVC CHF incl. |
|-------------------|-----------------------------|-----------------------------|-----------|----------|----------------------------------|----------------------------------|
|-------------------|-----------------------------|-----------------------------|-----------|----------|----------------------------------|----------------------------------|

WC-Sitz ComfortPlus Slow Down

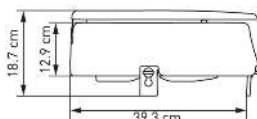
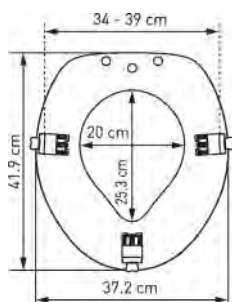

Siège WC ComfortPlus Slow Down

| | | | | | | | |
|---|--|-------------------|----------------------------------|---|---|---------------|---------------|
|  |  7 611038 174569 | 31 1691 41 | weiss blanc 41.9 x 37.2 cm | 1 |  | 109.04 | 117.43 |
| | | | | | | | |



Befestigungsset

Fixation



| | | | | | | | |
|--|---|-------------------|--|---|--|--------------|--------------|
|  |  7 611038 174675 | 31 1691 96 | | 1 |  | 12.21 | 13.15 |
| | | | | | | | |

Duroplast - Comfort

| | | | | | | | |
|--|--------------------------|------------------------------------|------------------------------------|------------------|-----------------|---|---|
| | EAN-Nr. <i>no EAN</i> | Artikel Nr. <i>no d'article</i> | Beschreibung <i>description</i> | VPE <i>ce</i> | VE <i>ue</i> | UVP pro Stk. <i>PVC</i> CHF excl. | UVP pro Stk. <i>PVC</i> CHF incl. |
|--|--------------------------|------------------------------------|------------------------------------|------------------|-----------------|---|---|

WC-Sitz Comfort Slow Down

Siège de WC Comfort Slow Down

| | | | | | | | |
|---|--|------------|--|---|---|--------|--------|
|  |  7 611038 098889 | 31 1690 41 | weiss <i>blanc</i> 42 - 44 x 37 cm ; 8 | 4 |  | 130.47 | 140.52 |
| | | | | | | | |



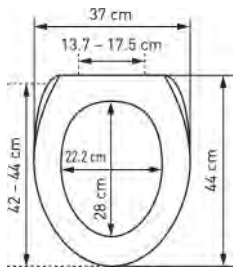

Bequemerer Sitzwinkel durch erhöhte Sitzposition.
Angle d'assise plus confortable grâce au siège surélevé.



aus Duroplast
mit Absenkautomatik
Um 5cm erhöhte Sitzposition
en plastique dur
abaissement automatique
Position assise augmenté de 5cm



Befestigungsgarnitur

Jeu de fixation

| | | | | | | | |
|---|--|------------|---|---|---|-------|------|
|  |  7 611038 176372 | 31 1690 98 | 8 | 2 |  | 28.78 | 31.— |
| | | | | | | | |

Pufferset



Set butoirs

| | | | | | | | |
|---|--|------------|----------------------------|---|---|-------|-------|
|  |  7 611038 142384 | 31 1690 96 | weiss <i>blanc</i> 8 | 1 |  | 13.98 | 15.06 |
| | | | | | | | |

2 Deckelpuffer & 2 Sitzpuffer
2 butoirs pour couvercle &
2 butoirs pour lunette

Duroplast - Perth LED

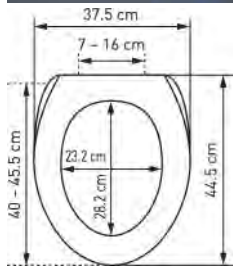

| EAN-Nr. <i>no EAN</i> | Artikel Nr. <i>no d'article</i> | Beschreibung <i>description</i> | VPE <i>ce</i> | VE <i>ue</i> | UVP pro Stk. <i>PVC</i> CHF excl. | UVP pro Stk. <i>PVC</i> CHF incl. |
|--------------------------|------------------------------------|------------------------------------|------------------|-----------------|---|---|
|--------------------------|------------------------------------|------------------------------------|------------------|-----------------|---|---|

| WC-Sitz Perth LED Slow Down | | Siège WC Perth LED Slow Down | | | | |
|---|-------------------|---|---|---|--------------|---------------|
|  | 31 1762 97 | weiss <i>blanc</i> 40-45.5 x 37.5 cm ; 19 | 5 |  | 94.13 | 101.38 |





- WC-Sitz mit zwei seitlichen LED Leuchten
- Licht schaltet durch Audiosensor und nur bei Dunkelheit ein und leuchtet ca. 2 Minuten
- Funktioniert mittels Batterien (2 x Typ AAA, LR03, 1.5V, nicht im Packungsinhalt)

aus Duroplast
mit Absenkautomatik
en plastique dur avec
abaissement automatique

| Befestigungsgarnitur | | Jeu de fixation | | | | |
|---|-------------------|-----------------|---|---|--------------|--------------|
|  | 31 1762 98 | 19 | 2 |  | 42.40 | 45.67 |





| Pufferset | | Set butoirs | | | | |
|---|-------------------|---------------------------|---|---|--------------|--------------|
|  | 31 1762 96 | grau <i>gris</i> 19 | 1 |  | 12.02 | 12.95 |



2 Deckelpuffer & 4 Sitzpuffer
2 butoirs pour couvercle &
4 butoirs pour lunette

Duroplast - Sidney LED

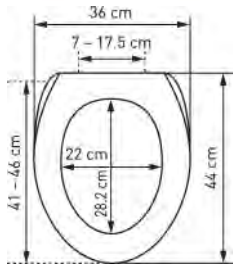

| EAN-Nr. no EAN | Artikel Nr. no d'article | Beschreibung description | VPE ce | VE ue | UVP pro Stk. PVC CHF excl. | UVP pro Stk. PVC CHF incl. |
|-------------------|-----------------------------|-----------------------------|-----------|----------|----------------------------------|----------------------------------|
|-------------------|-----------------------------|-----------------------------|-----------|----------|----------------------------------|----------------------------------|

| WC-Sitz Sidney LED Slow Down | | Siège WC Sidney LED Slow Down | | | | |
|---|-------------------|---|---|---|--------------|--------------|
|  | 31 1763 41 | weiss blanc 39.5-44.5 x 36 cm ; 9 | 5 |  | 86.67 | 93.35 |





aus Duroplast
mit Absenkautomatik
en plastique dur avec
abaissement automatique

- WC-Sitz mit LED Beleuchtung auf der Deckel Innen- und Aussenseite
- Licht schaltet durch Audiosensor und nur bei Dunkelheit ein und leuchtet ca. 2 Minuten
- Funktioniert mittels Batterien (2 x Typ AAA, LR03, 1.5V, nicht im Packungsinhalt)

| Befestigungsgarnitur | | Jeu de fixation | | | | |
|---|-------------------|-----------------|---|---|--------------|--------------|
|  | 31 1636 98 | 9 | 2 |  | 30.29 | 32.62 |



| Pufferset | | Set butoirs | | | | |
|---|-------------------|-------------------|---|---|--------------|--------------|
|  | 31 1636 96 | grau gris 9 | 1 |  | 12.02 | 12.95 |







2 Deckelpuffer & 4 Sitzpuffer
2 butoirs pour couvercle &
4 butoirs pour lunette

Duroplast - Race

| EAN-Nr. no EAN | Artikel Nr. no d'article | Beschreibung description | VPE ce | VE ue | UVP pro Stk. PVC CHF excl. | UVP pro Stk. PVC CHF incl. |
|-------------------|-----------------------------|-----------------------------|-----------|----------|----------------------------------|----------------------------------|
|-------------------|-----------------------------|-----------------------------|-----------|----------|----------------------------------|----------------------------------|

WC-Sitz Race Slow Down Siège de WC Race Slow Down

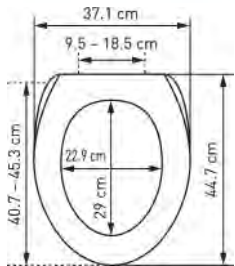

| | | | | | | | |
|---|--|-------------------|---|---|---|---------------|---------------|
|  |  7 611038 163051 | 31 1648 42 | weiss matt <i>blanc mat</i> 40.7-45.3 x 37.1 cm ; 24 | 5 |  | 101.58 | 109.40 |
| |  7 611038 188887 | 31 1648 79 | schwarz matt <i>noir mat</i> 40.7-45.3 x 37.1 cm ; 24 | 5 |  | 94.13 | 101.38 |



aus Duroplast
mit Absenkautomatik
en plastique dur
abaissement automatique



Befestigungsgarnitur Jeu de fixation

| | | | | | | | |
|---|--|-------------------|---------------------------------------|---|---|--------------|--------------|
|  |  7 611038 163235 | 31 1648 94 | bis 2023 <i>jusqu'à 2023</i> 24 | 1 |  | 28.89 | 31.12 |
|---|--|-------------------|---------------------------------------|---|---|--------------|--------------|



Pufferset Set butoirs

| | | | | | | | |
|---|--|-------------------|-----------------------|---|---|--------------|--------------|
|  |  7 611038 163242 | 31 1648 96 | weiss <i>blanc</i> | 1 |  | 12.02 | 12.95 |
|---|--|-------------------|-----------------------|---|---|--------------|--------------|

2 Deckelpuffer & 4 Sitzpuffer
2 butoirs pour couvercle &
4 butoirs pour lunette



Duroplast - Brest & Lille

| EAN-Nr. no EAN | Artikel Nr. no d'article | Beschreibung description | VPE ce | VE ue | UVP pro Stk. PVC CHF excl. | UVP pro Stk. PVC CHF incl. |
|-------------------|-----------------------------|-----------------------------|-----------|----------|----------------------------------|----------------------------------|
|-------------------|-----------------------------|-----------------------------|-----------|----------|----------------------------------|----------------------------------|

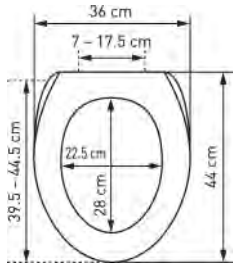
| WC-Sitz Brest "all in one" | | Siège de WC Brest "all in one" | | | | | |
|---|--|--------------------------------|-------------------------------------|---|---|-------|-------|
|  |  7 611038 099855 | 31 1636 41 | weiss blanc 39.5-44.5 x 36 cm | 5 |  | 85.74 | 92.34 |





aus Duroplast
mit Absenkautomatik
en plastique dur
abaissement automatique

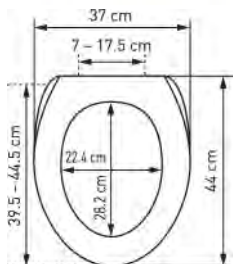

| WC-Sitz Lille Slow Down | | Siège de WC Lille Slow Down | | | | | |
|---|--|-----------------------------|-------------------------------------|---|---|-------|-------|
|  |  7 611038 099848 | 31 1635 41 | weiss blanc 39.5-44.5 x 37 cm | 5 |  | 73.62 | 79.29 |



aus Duroplast
mit Absenkautomatik
en plastique dur
abaissement automatique

| Befestigungsgarnitur | | Jeu de fixation | | | | | |
|---|--|-----------------|---|---|---|-------|-------|
|  |  7 611038 136772 | 31 1636 98 | 9 | 2 |  | 30.29 | 32.62 |



Duroplast - Brest & Lille

| | EAN-Nr. <i>no EAN</i> | Artikel Nr. <i>no d'article</i> | Beschreibung <i>description</i> | VPE <i>ce</i> | VE <i>ue</i> | UVP pro Stk. <i>PVC</i> CHF excl. | UVP pro Stk. <i>PVC</i> CHF incl. |
|---|--|------------------------------------|------------------------------------|------------------|---|---|---|
| Pufferset | | Set butoirs | | | | | |
|  |  7 611038 136611 | 31 1636 96 | grau <i>gris</i> 9 | 1 |  | 12.02 | 12.95 |

2 Deckelpuffer & 4 Sitzpuffer
2 butoirs pour couvercle &
4 butoirs pour lunette



Duroplast - Plain

| EAN-Nr. <i>no EAN</i> | Artikel Nr. <i>no d'article</i> | Beschreibung <i>description</i> | VPE <i>ce</i> | VE <i>ue</i> | UVP pro Stk. <i>PVC</i> CHF excl. | UVP pro Stk. <i>PVC</i> CHF incl. |
|--------------------------|------------------------------------|------------------------------------|------------------|-----------------|---|---|
|--------------------------|------------------------------------|------------------------------------|------------------|-----------------|---|---|

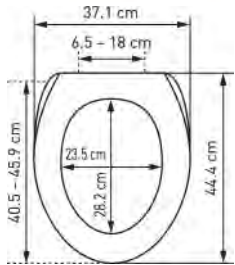
| WC-Sitz Plain Slow Down | | Siège de WC Plain Slow Down | | | | | |
|---|--|-----------------------------|---|---|---|--------------|--------------|
|  |  7 611038 163068 | 31 1631 41 | weiss <i>blanc</i> 40.5-44.5 x 37.1 cm ; 25 | 4 |  | 78.28 | 84.31 |





aus Duroplast
mit Absenkautomatik
en plastique dur
abaissement automatique

| Befestigungsgarnitur | | Jeu de fixation | | | | | |
|---|--|-------------------|----|---|---|--------------|--------------|
|  |  7 611038 163266 | 31 1631 94 | 25 | 1 |  | 28.89 | 31.12 |

Duroplast - Hollywood



| EAN-Nr. no EAN | Artikel Nr. no d'article | Beschreibung description | VPE ce | VE ue | UVP pro Stk. PVC CHF excl. | UVP pro Stk. PVC CHF incl. |
|-------------------|-----------------------------|-----------------------------|-----------|----------|----------------------------------|----------------------------------|
|-------------------|-----------------------------|-----------------------------|-----------|----------|----------------------------------|----------------------------------|

WC-Sitz Hollywood Slow Down Siège WC Hollywood Slow Down

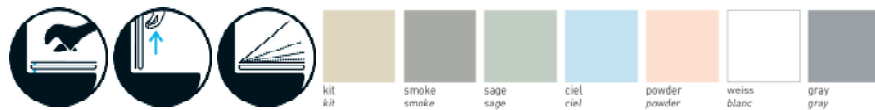

| | | | | | | | |
|---|---|-------------------|--|---|--|--------------|--------------|
|  <p>aus Duroplast mit Absenkautomatik Ringfarbe: weiss en plastique dur abaissement automatique couleur de la lunette: blanc</p> |  7 611038 166663 | 31 1679 32 | kit 41.5-45 x 38.2 cm ; 10 | 4 |  | 81.08 | 87.32 |
| |  7 611038 166656 | 31 1679 33 | smoke 41.5-45 x 38.2 cm ; 10 | 4 |  | 81.08 | 87.32 |
| |  7 611038 166670 | 31 1679 34 | sage 41.5-45 x 38.2 cm ; 10 | 4 |  | 81.08 | 87.32 |
| |  7 611038 166687 | 31 1679 35 | ciel 41.5-45 x 38.2 cm ; 10 | 4 |  | 81.08 | 87.32 |
| |  7 611038 166694 | 31 1679 36 | powder 41.5-45 x 38.2 cm ; 10 | 4 |  | 81.08 | 87.32 |
| |  7 611038 166700 | 31 1679 41 | weiss blanc 41.5-45 x 38.2 cm ; 10 | 4 |  | 81.08 | 87.32 |
| |  7 611038 166649 | 31 1679 58 | gray gris 41.5-45 x 38.2 cm ; 10 | 4 |  | 81.08 | 87.32 |



Befestigungsgarnitur Jeu de fixation

| | | | | | | | |
|---|--|-------------------|----|---|---|--------------|--------------|
|  |  7 611038 166755 | 31 1679 94 | 10 | 1 |  | 24.23 | 26.10 |
|---|--|-------------------|----|---|---|--------------|--------------|



Pufferset Set butoirs

| | | | | | | | |
|---|--|-------------------|----|---|---|--------------|--------------|
|  |  7 611038 166779 | 31 1679 96 | 10 | 1 |  | 11.56 | 12.45 |
|---|--|-------------------|----|---|---|--------------|--------------|

2 Deckelpuffer & 4 Sitzpuffer
 2 butoirs pour couvercle &
 4 butoirs pour lunette



Duroplast - Pike

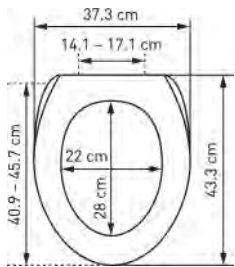

| EAN-Nr. <i>no EAN</i> | Artikel Nr. <i>no d'article</i> | Beschreibung <i>description</i> | VPE <i>ce</i> | VE <i>ue</i> | UVP pro Stk. <i>PVC</i> CHF excl. | UVP pro Stk. <i>PVC</i> CHF incl. |
|--------------------------|------------------------------------|------------------------------------|------------------|-----------------|---|---|
|--------------------------|------------------------------------|------------------------------------|------------------|-----------------|---|---|

| WC-Sitz Pike Slow Down | | Siège de WC Pike Slow Down | | | | | |
|---|--|----------------------------|---|---|---|--------------|--------------|
|  |  7 611038 166533 | 31 1681 41 | weiss <i>blanc</i> 40.9-45.7 x 37.3 cm ; 11 | 7 |  | 76.42 | 82.30 |



aus Duroplast
 mit Absenkautomatik
en plastique dur
abaissement automatique



| Excenterscharnier Eco | | Charnière excentrique Eco | | | | | |
|---|--|---------------------------|--|---|---|--------------|--------------|
|  |  4 016959 108335 | 31 1664 96 | Nylon - Edelstahl <i>nylon - inox</i> 11 | 1 |  | 37.28 | 40.15 |

| Pufferset | | Set butoirs | | | | | |
|---|--|-------------------|-----------------------|---|---|--------------|--------------|
|  |  4 016959 128722 | 31 1681 96 | weiss <i>blanc</i> | 1 |  | 12.30 | 13.25 |

2 Deckelpuffer & 4 Sitzpuffer
2 butoirs pour couvercle &
4 butoirs pour lunette



Duroplast - Rouen

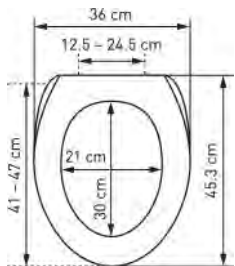

| EAN-Nr. no EAN | Artikel Nr. no d'article | Beschreibung description | VPE ce | VE ue | UVP pro Stk. PVC CHF excl. | UVP pro Stk. PVC CHF incl. |
|-------------------|-----------------------------|-----------------------------|-----------|----------|----------------------------------|----------------------------------|
|-------------------|-----------------------------|-----------------------------|-----------|----------|----------------------------------|----------------------------------|

| WC-Sitz Rouen Slow Down | | Siège de WC Rouen Slow Down | | | | | |
|---|--|-----------------------------|---------------------------------|---|---|-------|-------|
|  |  7 611038 174767 | 31 1609 41 | weiss blanc 41-47 x 36 cm | 5 |  | 78.28 | 84.31 |



Extra flacher Sitz
aus Duroplast
mit Absenkautomatik
Siège extra plat
en plastique dur
abaissement automatique

| Befestigungsgarnitur | | Jeu de fixation | | | | | |
|---|--|-----------------|----|---|---|-------|-------|
|  |  7 611038 174682 | 31 1609 96 | 17 | 1 |  | 27.96 | 30.11 |

| Pufferset | | Set butoirs | | | | | |
|---|--|-------------|--------------------|---|---|-------|-------|
|  |  7 611038 181369 | 31 1605 96 | grau gris 26 | 1 |  | 12.02 | 12.95 |



2 Deckelpuffer & 4 Sitzpuffer
2 butoirs pour couvercle &
4 butoirs pour lunette

Duroplast - Evia & Laval

| EAN-Nr. no EAN | Artikel Nr. no d'article | Beschreibung description | VPE ce | VE ue | UVP pro Stk. PVC CHF excl. | UVP pro Stk. PVC CHF incl. |
|-------------------|-----------------------------|-----------------------------|-----------|----------|----------------------------------|----------------------------------|
|-------------------|-----------------------------|-----------------------------|-----------|----------|----------------------------------|----------------------------------|

WC-Sitz Evia Slow Down

Siège de WC Evia Slow Down

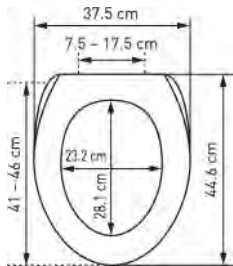

| | | | | | | | |
|---|--|-------------------|--|---|---|--------------|--------------|
|  |  7 611038 140007 | 31 1678 41 | weiss blanc 41 - 46 x 37.5 cm ; 11 | 7 |  | 71.76 | 77.29 |
|---|--|-------------------|--|---|---|--------------|--------------|



aus Duroplast
mit Absenkautomatik
en plastique dur
abaissement automatique

WC-Sitz Laval Slow Down

Siège de WC Laval Slow Down

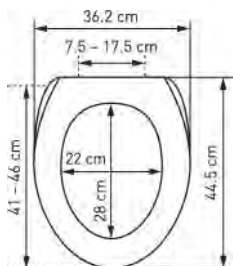

| | | | | | | | |
|---|--|-------------------|--|---|---|--------------|--------------|
|  |  7 611038 139995 | 31 1677 41 | weiss blanc 41 - 46 x 36.2 cm ; 11 | 7 |  | 71.76 | 77.29 |
|---|--|-------------------|--|---|---|--------------|--------------|





aus Duroplast
mit Absenkautomatik
en plastique dur
abaissement automatique

Excenterscharnier Eco

Charnière excentrique Eco

| | | | | | | | |
|---|--|-------------------|---|---|---|--------------|--------------|
|  |  4 016959 108335 | 31 1664 96 | Nylon - Edelstahl nylon - inox 11 | 1 |  | 37.28 | 40.15 |
|---|--|-------------------|---|---|---|--------------|--------------|

Duroplast - Evia & Laval

| | EAN-Nr. <i>no EAN</i> | Artikel Nr. <i>no d'article</i> | Beschreibung <i>description</i> | VPE <i>ce</i> | VE <i>ue</i> | UVP pro Stk. <i>PVC</i> CHF excl. | UVP pro Stk. <i>PVC</i> CHF incl. |
|---|---|------------------------------------|------------------------------------|------------------|---|---|---|
| Pufferset | | Set butoirs | | | | | |
|  |  | 33 2105 96 | weiss <i>blanc</i> | 1 |  | 10.90 | 11.74 |

2 Deckelpuffer & 4 Sitzpuffer
2 butoirs pour couvercle &
4 butoirs pour lunette

Duroplast - Barbana & Formica

| EAN-Nr. no EAN | Artikel Nr. no d'article | Beschreibung description | VPE ce | VE ue | UVP pro Stk. PVC CHF excl. | UVP pro Stk. PVC CHF incl. |
|-------------------|-----------------------------|-----------------------------|-----------|----------|----------------------------------|----------------------------------|
|-------------------|-----------------------------|-----------------------------|-----------|----------|----------------------------------|----------------------------------|

WC-Sitz Barbana® Slow Down

Siège de WC Barbana® Slow Down

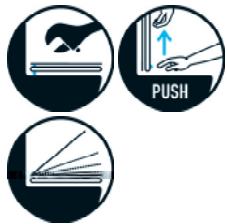
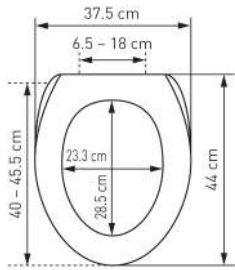

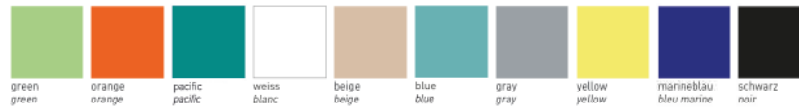

aus Duroplast
mit Absenkautomatik
en plastique dur
abaissement automatique

| | | | | | | |
|--|-------------------|--|---|--|--------------|--------------|
| | 31 1666 04 | green vert 40-45.5 x 37.5 cm ; 1 | 4 | | 79.22 | 85.32 |
| | 31 1666 11 | orange 40-45.5 x 37.5 cm ; 1 | 4 | | 79.22 | 85.32 |
| | 31 1666 37 | pacific 40-45.5 x 37.5 cm ; 1 | 4 | | 79.22 | 85.32 |
| | 31 1666 41 | weiss blanc 40-45.5 x 37.5 cm ; 1 | 4 | | 70.83 | 76.28 |
| | 31 1666 46 | beige 40-45.5 x 37.5 cm ; 1 | 4 | | 79.22 | 85.32 |
| | 31 1666 56 | blue 40-45.5 x 37.5 cm ; 1 | 4 | | 79.22 | 85.32 |
| | 31 1666 58 | gray gris 40-45.5 x 37.5 cm ; 1 | 4 | | 79.22 | 85.32 |
| | 31 1666 70 | yellow jaune 40-45.5 x 37.5 cm ; 1 | 4 | | 79.22 | 85.32 |
| | 31 1666 78 | marineblau bleu marine 40-45.5 x 37.5 cm ; 1 | 4 | | 79.22 | 85.32 |
| | 31 1666 80 | schwarz noir 40-45.5 x 37.5 cm ; 1 | 4 | | 79.22 | 85.32 |





Duroplast - Barbana & Formica

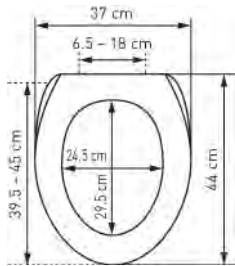

| EAN-Nr. <i>no EAN</i> | Artikel Nr. <i>no d'article</i> | Beschreibung <i>description</i> | VPE <i>ce</i> | VE <i>ue</i> | UVP pro Stk. <i>PVC</i> CHF excl. | UVP pro Stk. <i>PVC</i> CHF incl. |
|--------------------------|------------------------------------|------------------------------------|------------------|-----------------|---|---|
|--------------------------|------------------------------------|------------------------------------|------------------|-----------------|---|---|

| WC-Sitz Formica Slow Down | | Siège de WC Formica Slow Down | | | | | |
|---|--|-------------------------------|--|---|---|--------------|--------------|
|  |  7 611038 093235 | 31 1667 41 | weiss <i>blanc</i> 39.5-45 x 37 cm ; 1 | 4 |  | 81.08 | 87.32 |





aus Duroplast
mit Absenkautomatik
en plastique dur
abaissement automatique

| Befestigungsgarnitur | | Jeu de fixation | | | | | |
|---|--|-------------------|---|---|---|--------------|--------------|
|  |  7 611038 098193 | 31 1668 98 | 1 | 2 |  | 29.36 | 31.62 |



| Scharnier BVO | | Charnière fixation par dessus | | | | | |
|---|--|-------------------------------|----------------------------|---|---|--------------|--------------|
|  |  7 611038 099817 | 31 1667 96 | verchromt <i>chromé</i> | 1 |  | 28.89 | 31.12 |

Duroplast - Barbana & Formica

| EAN-Nr. <i>no EAN</i> | Artikel Nr. <i>no d'article</i> | Beschreibung <i>description</i> | VPE <i>ce</i> | VE <i>ue</i> | UVP pro Stk. <i>PVC</i> CHF excl. | UVP pro Stk. <i>PVC</i> CHF incl. |
|--------------------------|------------------------------------|------------------------------------|------------------|-----------------|---|---|
|--------------------------|------------------------------------|------------------------------------|------------------|-----------------|---|---|

| Pufferset | | Set butoirs | | | | | |
|---|--|--------------------|-------------------|---|---|--------------|--------------|
|  |  7 611038 093266 | 31 1668 96 | grau gris 1 | 1 |  | 12.02 | 12.95 |

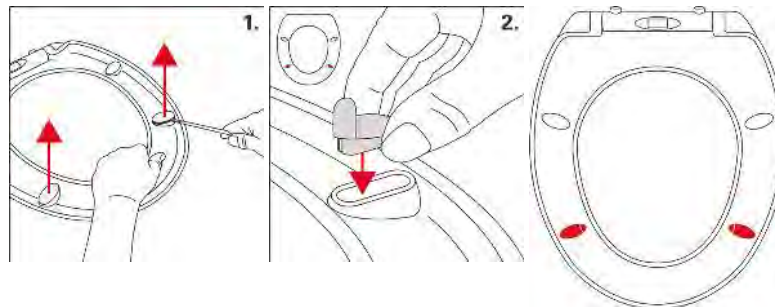

2 Deckelpuffer & 4 Sitzpuffer
 2 butoirs pour couvercle &
 4 butoirs pour lunette

| Sicherungs Pufferset | | Set butoirs sécuriser | | | | | |
|---|--|------------------------------|-------------------|---|---|-------------|-------------|
|  |  7 611038 185244 | 31 1668 93 | grau gris 1 | 1 |  | 5.92 | 6.37 |





Duroplast - Clichy

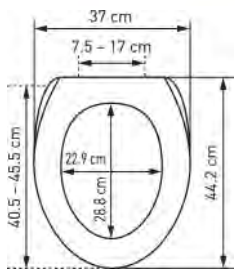

| EAN-Nr. no EAN | Artikel Nr. no d'article | Beschreibung description | VPE ce | VE ue | UVP pro Stk. PVC CHF excl. | UVP pro Stk. PVC CHF incl. |
|-------------------|-----------------------------|-----------------------------|-----------|----------|----------------------------------|----------------------------------|
|-------------------|-----------------------------|-----------------------------|-----------|----------|----------------------------------|----------------------------------|

| WC-Sitz Clichy Slow Down | | Siège de WC Clichy Slow Down | | | | |
|---|--|------------------------------|--|---|---|---------------------------|
|  |  7 611038 179939 | 31 1605 41 | weiss blanc 40.5-45.5 x 37 cm ; 26 | 5 |  | 68.96 74.27 |



Extra flacher Sitz
aus Duroplast
mit Absenkautomatik
*Siège extra plat
en plastique dur
abaissement automatique*



| Befestigungsgarnitur bis 2018 | | Jeu de fixation jusque à 2018 | | | | |
|---|--|-------------------------------|--|---|---|---------------------------|
|  |  7 611038 181352 | 31 1605 94 | | 1 |  | 27.96 30.11 |

| Pufferset | | Set butoirs | | | | |
|---|--|-------------------|--------------------|---|---|---------------------------|
|  |  7 611038 181369 | 31 1605 96 | grau gris 26 | 1 |  | 12.02 12.95 |

2 Deckelpuffer & 4 Sitzpuffer
*2 butoirs pour couvercle &
4 butoirs pour lunette*



Duroplast - Avignon

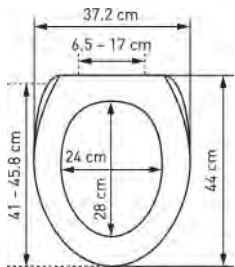

| EAN-Nr. no EAN | Artikel Nr. no d'article | Beschreibung description | VPE ce | VE ue | UVP pro Stk. PVC CHF excl. | UVP pro Stk. PVC CHF incl. |
|-------------------|-----------------------------|-----------------------------|-----------|----------|----------------------------------|----------------------------------|
|-------------------|-----------------------------|-----------------------------|-----------|----------|----------------------------------|----------------------------------|

| WC-Sitz Avignon Slow Down | | Siège de WC Avignon Slow Down | | | | | |
|---|--|-------------------------------|--|---|---|--------------|--------------|
|  |  7 611038 179946 | 31 1606 41 | weiss blanc 41-45.8 x 37 cm ; 12 | 5 |  | 57.78 | 62.23 |



Extra flacher Sitz
aus Duroplast
mit Absenkautomatik
Siège extra plat
en plastique dur
abaissement automatique



| Befestigungsgarnitur | | Jeu de fixation | | | | | |
|---|--|-------------------|----|---|---|--------------|--------------|
|  |  7 611038 181338 | 31 1606 94 | 12 | 1 |  | 27.96 | 30.11 |

| Pufferset | | Set butoirs | | | | | |
|---|--|-------------------|--------------------|---|---|--------------|--------------|
|  |  7 611038 181345 | 31 1606 96 | grau gris 12 | 1 |  | 11.84 | 12.75 |

2 Deckelpuffer & 4 Sitzpuffer
2 butoirs pour couvercle &
4 butoirs pour lunette



Duroplast - Martano & Toulon

| EAN-Nr. no EAN | Artikel Nr. no d'article | Beschreibung description | VPE ce | VE ue | UVP pro Stk. PVC CHF excl. | UVP pro Stk. PVC CHF incl. |
|-------------------|-----------------------------|-----------------------------|-----------|----------|----------------------------------|----------------------------------|
|-------------------|-----------------------------|-----------------------------|-----------|----------|----------------------------------|----------------------------------|

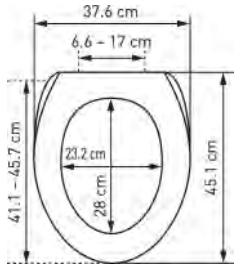
| WC-Sitz Martano Slow Down | | Siège de WC Martano Slow Down | | | | |
|---|-------------------|--|---|---|--------------|--------------|
|  | 31 1607 41 | weiss blanc 41.1-45.7 x 37.6 cm ; 33 | 5 |  | 44.73 | 48.18 |



aus Duroplast
mit Absenkautomatik
*en plastique dur
abaissement automatique*

| WC-Sitz Toulon Slow Down | | Siège de WC Toulon Slow Down | | | | |
|---|-------------------|---|---|---|--------------|--------------|
|  | 31 1603 41 | weiss blanc 41-46 x 38 cm ; 14/33 | 5 |  | 45.67 | 49.18 |

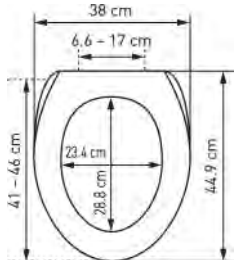



Extra flacher Sitz
aus Duroplast
mit Absenkautomatik
*Siège extra plat
en plastique dur
abaissement automatique*

Duroplast - Martano & Toulon

| | EAN-Nr. <i>no EAN</i> | Artikel Nr. <i>no d'article</i> | Beschreibung <i>description</i> | VPE <i>ce</i> | VE <i>ue</i> | UVP pro Stk. <i>PVC</i> CHF excl. | UVP pro Stk. <i>PVC</i> CHF incl. |
|--|--------------------------|------------------------------------|------------------------------------|------------------|-----------------|---|---|
|--|--------------------------|------------------------------------|------------------------------------|------------------|-----------------|---|---|



Befestigungsgarnitur bis 2020

Jeu de fixation jusqu'à 2020

| | | | | | | | |
|---|--|-------------------|----|---|---|--------------|--------------|
|  |  7 611038 172619 | 31 1689 98 | 14 | 2 |  | 18.08 | 19.47 |
|---|--|-------------------|----|---|---|--------------|--------------|

Pufferset



Set butoirs

| | | | | | | | |
|---|--|-------------------|-----------------------------|---|---|--|--|
|  |  7 611038 162603 | 31 1689 96 | weiss <i>blanc</i> 14 | 1 |  | | |
|---|--|-------------------|-----------------------------|---|---|--|--|

2 Deckelpuffer & 4 Sitzpuffer
2 butoirs pour couvercle &
4 butoirs pour lunette



Duroplast - Dijon & Vienna

| EAN-Nr. <i>no EAN</i> | Artikel Nr. <i>no d'article</i> | Beschreibung <i>description</i> | VPE <i>ce</i> | VE <i>ue</i> | UVP pro Stk. <i>PVC</i> CHF excl. | UVP pro Stk. <i>PVC</i> CHF incl. |
|--------------------------|------------------------------------|------------------------------------|------------------|-----------------|---|---|
|--------------------------|------------------------------------|------------------------------------|------------------|-----------------|---|---|

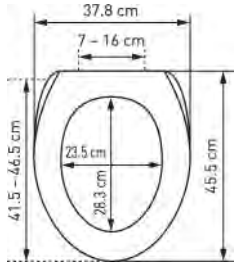
| WC-Sitz Dijon Slow Down | | Siège de WC Dijon Slow Down | | | | |
|---|--|-----------------------------|--|---|---|---------------------------|
|  |  7 611038 136840 | 31 1644 41 | weiss <i>blanc</i> 41.5 - 46.5 x 37.8 cm ; 2 | 5 |  | 44.73 48.18 |



aus Duroplast
mit Absenkautomatik
en plastique dur
abaissement automatique

| WC-Sitz Vienna Slow Down | | Siège de WC Vienna Slow Down | | | | |
|---|--|------------------------------|--|---|---|---------------------------|
|  |  7 611038 097585 | 31 1673 41 | weiss <i>blanc</i> 41.5 - 45.5 - 37.9 cm ; 2 | 5 |  | 44.73 48.18 |

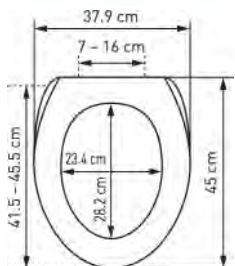

aus Duroplast
mit Absenkautomatik
en plastique dur
abaissement automatique

Duroplast - Dijon & Vienna

| | EAN-Nr. <i>no EAN</i> | Artikel Nr. <i>no d'article</i> | Beschreibung <i>description</i> | VPE <i>ce</i> | VE <i>ue</i> | UVP pro Stk. <i>PVC</i> CHF excl. | UVP pro Stk. <i>PVC</i> CHF incl. |
|--|--------------------------|------------------------------------|------------------------------------|------------------|-----------------|---|---|
|--|--------------------------|------------------------------------|------------------------------------|------------------|-----------------|---|---|

Befestigungsgarnitur neu

Jeu de fixation nouveau



| | | | | | | |
|-----------------|-------------------|---------------------------------|----|--|--------------|--------------|
| 7 611038 167257 | 31 1644 96 | ab 2016 <i>dès 2016</i> 2 | 50 | | 17.71 | 19.07 |
| 7 611038 181253 | 31 1644 98 | ab 2016 <i>dès 2016</i> 2 | 2 | | 18.64 | 20.07 |

Pufferset

Set butoirs





| | | | | | | |
|-----------------|-------------------|----------------------------|---|--|--------------|--------------|
| 7 611038 136703 | 31 1712 94 | weiss <i>blanc</i> 2 | 1 | | 12.02 | 12.95 |
|-----------------|-------------------|----------------------------|---|--|--------------|--------------|

2 Deckelpuffer & 4 Sitzpuffer
2 butoirs pour couvercle &
4 butoirs pour lunette



Duroplast - Derval

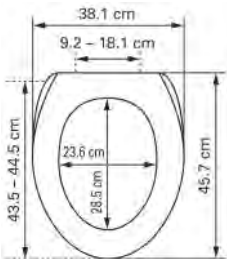

| EAN-Nr. <i>no EAN</i> | Artikel Nr. <i>no d'article</i> | Beschreibung <i>description</i> | VPE <i>ce</i> | VE <i>ue</i> | UVP pro Stk. <i>PVC</i> CHF excl. | UVP pro Stk. <i>PVC</i> CHF incl. |
|--------------------------|------------------------------------|------------------------------------|------------------|-----------------|---|---|
|--------------------------|------------------------------------|------------------------------------|------------------|-----------------|---|---|

| WC-Sitz Derval Slow Down | | Siège de WC Derval Slow Down | | | | | |
|---|--|------------------------------|---|---|---|--------------|--------------|
|  |  7 611038 834982 | 31 1595 41 | weiss <i>blanc</i> 43.5-44.5 x 38 cm ; 35 | 4 |  | 43.34 | 46.67 |



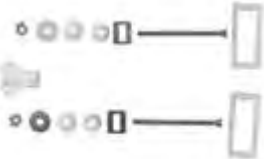

aus Duroplast
mit Absenkautomatik
en plastique dur
abaissement automatique

| Ersatzscharnier | | Charnière de remplacement | | | | | |
|---|--|---------------------------|----------------------------|---|---|--------------|--------------|
|  |  7 611038 426279 | 31 1595 94 | verchromt <i>chromé</i> | 1 |  | 19.38 | 20.88 |

| Befestigungen | | Jeu de fixation | | | | | |
|---|--|-------------------|----|---|---|--------------|--------------|
|  |  7 611038 426262 | 31 1595 95 | 35 | 1 |  | 12.58 | 13.55 |



Duroplast - Derval

| | EAN-Nr. <i>no EAN</i> | Artikel Nr. <i>no d'article</i> | Beschreibung <i>description</i> | VPE <i>ce</i> | VE <i>ue</i> | UVP pro Stk. <i>PVC</i> CHF excl. | UVP pro Stk. <i>PVC</i> CHF incl. |
|---|--|------------------------------------|------------------------------------|------------------|---|---|---|
| Pufferset | | Set butoirs | | | | | |
|  |  7 611038 426255 | 31 1595 96 | weiss <i>blanc</i> | 1 |  | 11.— | 11.84 |
| | | | | | | | |

2 Deckelpuffer & 4 Sitzpuffer
2 butoirs pour couvercle &
4 butoirs pour lunette

Duroplast - Move



| EAN-Nr. <i>no EAN</i> | Artikel Nr. <i>no d'article</i> | Beschreibung <i>description</i> | VPE <i>ce</i> | VE <i>ue</i> | UVP pro Stk. <i>PVC</i> CHF excl. | UVP pro Stk. <i>PVC</i> CHF incl. |
|--------------------------|------------------------------------|------------------------------------|------------------|-----------------|---|---|
|--------------------------|------------------------------------|------------------------------------|------------------|-----------------|---|---|

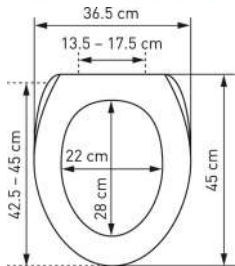

| WC-Sitz Move | | Siège de WC Move | | | | | |
|---|--|-------------------|--|---|---|--------------|--------------|
|  |  7 611038 113940 | 31 1655 41 | weiss <i>blanc</i> 42.5-45 cm x 36.5 cm ; 31 | 1 |  | 92.26 | 99.37 |



aus Duroplast mit Excenterscharnier Edelstahl.
Passend zu Keramik Moderna (Laufen).

*en plastique dur avec charnières excentriques acier raffiné.
Adaptable pour céramique Moderna (Laufen).*



| Exzentrerscharnier | | Charnière excentrique | | | | | |
|---|--|-----------------------|---|---|---|--------------|--------------|
|  |  7 611038 071769 | 33 2201 98 | FastFix, Edelstahl <i>FastFix, acier raffiné</i> 31 | 2 |  | 36.81 | 39.65 |

| Pufferset | | Set butoirs | | | | | |
|---|--|-------------------|-----------------------|---|---|--------------|--------------|
|  |  7 611038 117146 | 33 2105 96 | weiss <i>blanc</i> | 1 |  | 10.90 | 11.74 |

2 Deckelpuffer & 4 Sitzpuffer
2 butoirs pour couvercle & 4 butoirs pour lunette



Duroplast - Verona



| EAN-Nr. no EAN | Artikel Nr. no d'article | Beschreibung description | VPE ce | VE ue | UVP pro Stk. PVC CHF excl. | UVP pro Stk. PVC CHF incl. |
|-------------------|-----------------------------|-----------------------------|-----------|----------|----------------------------------|----------------------------------|
|-------------------|-----------------------------|-----------------------------|-----------|----------|----------------------------------|----------------------------------|

| WC-Sitz Verona | | Siège de WC Verona | | | | | |
|---|---|--------------------|---|---|---|---------------|---------------|
|  |  | 31 1760 41 | weiss - INOX Scharnier <i>blanc - charnières INOX</i> 42-43.5 x 37.5 cm | 7 |  | 105.31 | 113.42 |



aus Duroplast mit
Inox-Scharnier
*en plastique dur avec
charnière en Inox*

| Excenterscharnier | | Charnière excentrique | | | | | |
|---|---|-----------------------|---|----|---|--------------|--------------|
|  |  | E12 | FastFix, Edelstahl <i>FastFix, acier raffiné</i> | 10 |  | 34.02 | 36.64 |





| Pufferset | | Set butoirs | | | | | |
|---|---|-------------------|-----------------------|---|---|--------------|--------------|
|  |  | 33 2105 96 | weiss <i>blanc</i> | 1 |  | 10.90 | 11.74 |

2 Deckelpuffer & 4 Sitzpuffer
*2 butoirs pour couvercle &
4 butoirs pour lunette*

Duroplast - Malaga

| EAN-Nr. no. EAN | Artikel Nr. no d'article | Beschreibung description | VPE ce | VE ue | UVP pro Stk. PVC CHF excl. | UVP pro Stk. PVC CHF incl. |
|--------------------|-----------------------------|-----------------------------|-----------|----------|----------------------------------|----------------------------------|
|--------------------|-----------------------------|-----------------------------|-----------|----------|----------------------------------|----------------------------------|

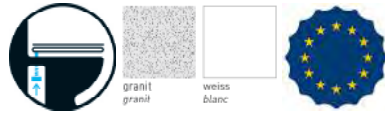
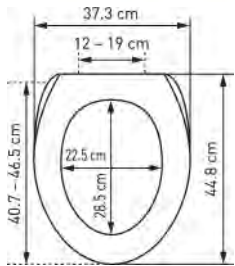

WC-Sitz Malaga Siège de WC Malaga

| | | | | | | | |
|---|---|-------------------|--|---|---|--------------|--------------|
|  |  | 31 1653 08 | granit 40.7-46.5 x 37.3 cm ; 23 | 7 |  | 43.80 | 47.17 |
| |  | 31 1653 41 | weiss blanc 40.7-46.5 x 37.3 cm ; 23 | 7 |  | 43.80 | 47.17 |





aus Duroplast mit
Nylon-Scharnier
en plastique dur avec
charnière en Nylon

Befestigungsgarnitur Jeu de fixation





| | | | | | | | |
|---|---|-------------------|-------------------------------------|---|---|--------------|--------------|
|  |  | 32 2211 98 | weiss / Nylon blanc / Nylon 4 | 3 |  | 14.35 | 15.46 |
|---|---|-------------------|-------------------------------------|---|---|--------------|--------------|

Pufferset Set butoirs

| | | | | | | | |
|---|---|-------------------|----------------|---|---|--------------|--------------|
|  |  | 33 2108 96 | weiss blanc | 1 |  | 25.16 | 27.10 |
|---|---|-------------------|----------------|---|---|--------------|--------------|















2 Deckpuffer & 4 Sitzpuffer
2 butoirs pour couvercle &
4 butoirs pour lunette



Duroplast - Malaga

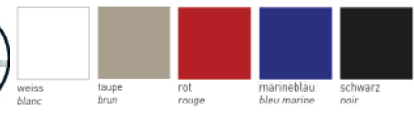

| | EAN-Nr. <i>no EAN</i> | Artikel Nr. <i>no d'article</i> | Beschreibung <i>description</i> | VPE <i>ce</i> | VE <i>ue</i> | UVP pro Stk. <i>PVC</i> CHF excl. | UVP pro Stk. <i>PVC</i> CHF incl. |
|---|--|------------------------------------|------------------------------------|------------------|---|---|---|
| Pufferset alt | | Set butoirs ancien | | | | | |
|    |  7 611038 073015 | 32 2243 96 | grau <i>gris</i> | 1 |  | 11.— | 11.84 |

2 Deckelpuffer & 4 Sitzpuffer
2 butoirs pour couvercle &
4 butoirs pour lunette

Wood - Bilbao

| | EAN-Nr. no EAN | Artikel Nr. no d'article | Beschreibung description | VPE ce | VE ue | UVP pro Stk. PVC CHF excl. | UVP pro Stk. PVC CHF incl. |
|--|---|---|---|--|---|----------------------------------|----------------------------------|
| WC-Sitz Bilbao Slow Down | | Siège de WC Bilbao Slow Down | | | | | |
|  |  | 31 1703 41 | weiss - MDF - FSC® 100% <i>blanc - MDF - FSC® 100%</i> 42-46.5 x 37.1 cm ; 34 | 4 |  | 80.15 | 86.32 |
| |  | 31 1703 45 | taupe - MDF - FSC® 100% <i>43-47 x 37.1 cm ; 34</i> | 4 |  | 80.15 | 86.32 |
| |  | 31 1703 72 | rot RAL 3003 - MDF - FSC® 100% <i>rouge RAL 3003 - MDF-FSC® 100%</i> 42-46.5 x 37.1 cm ; 34 | 4 |  | 80.15 | 86.32 |
| |  | 31 1703 78 | marineblau - MDF - FSC® 100% <i>bleu marine - MDF - FSC® 100%</i> 42-46.5 x 37.1 cm ; 34 | 4 |  | 80.15 | 86.32 |
| |  | 31 1703 80 | schwarz - MDF - FSC® 100% <i>noir - MDF - FSC® 100%</i> 42-46.5 x 37.1 cm ; 34 | 4 |  | 80.15 | 86.32 |
|  | |  | |  | | | |

| Befestigungsset | | Jeu de fixation | | | | | |
|---|---|------------------------|----|---|---|--------------|--------------|
|  |  | 31 1703 94 | 34 | 1 |  | 16.68 | 17.97 |

| Ersatzbremse | | Frein de remplacement | | | | | |
|---|---|------------------------------|----------------------------------|---|---|--------------|--------------|
|  |  | 31 1703 95 | verchromt <i>chromé</i> 34 | 1 |  | 49.39 | 53.20 |

Wood - Bilbao

| EAN-Nr. <i>no EAN</i> | Artikel Nr. <i>no d'article</i> | Beschreibung <i>description</i> | VPE <i>ce</i> | VE <i>ue</i> | UVP pro Stk. <i>PVC</i> CHF excl. | UVP pro Stk. <i>PVC</i> CHF incl. |
|--------------------------|------------------------------------|------------------------------------|------------------|-----------------|---|---|
|--------------------------|------------------------------------|------------------------------------|------------------|-----------------|---|---|

| | |
|------------------|--------------------|
| Pufferset | Set butoirs |
|------------------|--------------------|



31 1703 96

weiss
blanc
32, 34

1



11.28

12.14

2 Deckelpuffer & 4 Sitzpuffer
2 butoirs pour couvercle &
4 butoirs pour lunette

Wood - Troyes

| EAN-Nr. no EAN | Artikel Nr. no d'article | Beschreibung description | VPE ce | VE ue | UVP pro Stk. PVC CHF excl. | UVP pro Stk. PVC CHF incl. |
|-------------------|-----------------------------|-----------------------------|-----------|----------|----------------------------------|----------------------------------|
|-------------------|-----------------------------|-----------------------------|-----------|----------|----------------------------------|----------------------------------|

WC-Sitz Troyes Slow Down

Siège de WC Troyes Slow Down

| | | | | | | | |
|---|--|-------------------|--|---|---|---------------|---------------|
|  |  7 611038 188689 | 32 1510 97 | Beton grau - MDF - FSC® 100% <i>béton gris - MDF - FSC® 100%</i> 39-44 x 37.8 cm ; 32 | 4 |  | 105.31 | 113.42 |
|---|--|-------------------|--|---|---|---------------|---------------|



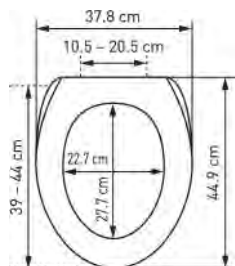

Das Zeichen für verantwortungsvolle Woodwirtschaft
Le mande de la gestion forestière responsable





Befestigungsgarnitur

Jeu de fixation

| | | | | | | | |
|---|--|-------------------|---------------------------------------|---|---|--------------|--------------|
|  |  7 611038 457945 | 32 1510 94 | schwarz matt <i>noir mat</i> 32 | 1 |  | 47.53 | 51.19 |
|---|--|-------------------|---------------------------------------|---|---|--------------|--------------|

Pufferset

Set butoirs





| | | | | | | | |
|---|--|-------------------|---------------------------------|---|---|--------------|--------------|
|  |  7 611038 834784 | 31 1703 96 | weiss <i>blanc</i> 32, 34 | 1 |  | 11.28 | 12.14 |
|---|--|-------------------|---------------------------------|---|---|--------------|--------------|

2 Deckelpuffer & 4 Sitzpuffer
 2 butoirs pour couvercle &
 4 butoirs pour lunette

Wood - Madrid

| EAN-Nr. no EAN | Artikel Nr. no d'article | Beschreibung description | VPE ce | VE ue | UVP pro Stk. PVC CHF excl. | UVP pro Stk. PVC CHF incl. |
|-------------------|-----------------------------|-----------------------------|-----------|----------|----------------------------------|----------------------------------|
|-------------------|-----------------------------|-----------------------------|-----------|----------|----------------------------------|----------------------------------|

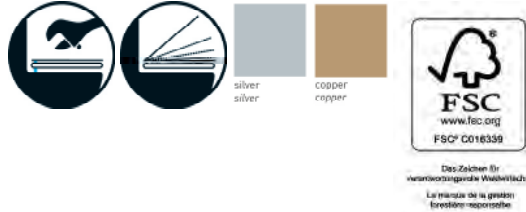

WC-Sitz Madrid Slow Down Siège de WC Madrid Slow Down

| | | | | | | | |
|---|--|-------------------|--|---|---|--------------|---------------|
|  |  7 611038 169428 | 31 1704 73 | silver - MDF - FSC® 100% 42-46.5 x 37.1 cm ; 16 | 4 |  | 94.13 | 101.38 |
| |  7 611038 169435 | 31 1704 83 | copper - MDF - FSC® 100% 42-46.5 x 37.1 cm ; 16 | 4 |  | 94.13 | 101.38 |





mit Metall-Scharnieren
avec charnières en métal



Ersatzbremse Frein de remplacement

| | | | | | | | |
|--|---|-------------------|---------------------|---|--|--------------|--------------|
|  |  7 611038 095833 | 31 1704 95 | verchromt chromé | 1 |  | 52.19 | 56.21 |
|--|---|-------------------|---------------------|---|--|--------------|--------------|

Befestigungsschrauben Visses de fixation

| | | | | | | | |
|---|--|-------------------|----|---|---|--------------|--------------|
|  |  7 611038 116613 | 31 1704 98 | 16 | 2 |  | 13.42 | 14.45 |
|---|--|-------------------|----|---|---|--------------|--------------|

Pufferset Set butoirs

| | | | | | | | |
|---|--|-------------------|----------------------|---|---|--------------|--------------|
|  |  7 611038 070656 | 31 1705 91 | weiss blanc 16 | 1 |  | 12.12 | 13.05 |
|---|--|-------------------|----------------------|---|---|--------------|--------------|



2 Deckpuffer & 4 Sitzpuffer
2 butoirs pour couvercle &
4 butoirs pour lunette

Wood - Lyon

| EAN-Nr. no EAN | Artikel Nr. no d'article | Beschreibung description | VPE ce | VE ue | UVP pro Stk. PVC CHF excl. | UVP pro Stk. PVC CHF incl. |
|-------------------|-----------------------------|-----------------------------|-----------|----------|----------------------------------|----------------------------------|
|-------------------|-----------------------------|-----------------------------|-----------|----------|----------------------------------|----------------------------------|

WC-Sitz Lyon Slow Down

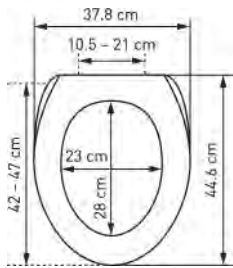

Siège de WC Lyon Slow Down

| | | | | | | | |
|---|--|-------------------|---|---|---|---------------|---------------|
|  |  7 611038 139599 | 32 1375 97 | Dark Bamboo dark Bamboo 42 - 47 x 37.8 cm ; 3 | 4 |  | 127.68 | 137.51 |
|---|--|-------------------|---|---|---|---------------|---------------|





Ersatzbremse

Frein de remplacement

| | | | | | | | |
|--|---|-------------------|--------------------------|---|--|--------------|--------------|
|  |  7 611038 095840 | 31 1710 95 | verchromt chromé 3 | 1 |  | 52.19 | 56.21 |
|--|---|-------------------|--------------------------|---|--|--------------|--------------|







Befestigungsgarnitur

Jeu de fixation

| | | | | | | | |
|---|--|-------------------|---|---|---|--------------|--------------|
|  |  7 611038 098162 | 31 1710 98 | 3 | 2 |  | 13.42 | 14.45 |
|---|--|-------------------|---|---|---|--------------|--------------|

Pufferset

Set butoirs

| | | | | | | | |
|---|--|-------------------|----------------------|---|---|--------------|--------------|
|  |  7 611038 098148 | 31 1710 96 | weiss blanc 3 | 1 |  | 11.65 | 12.55 |
|  |  7 611038 139803 | 31 1710 92 | schwarz noir 3 | 1 |  | 11.65 | 12.55 |

2 Deckelpuffer & 4 Sitzpuffer
2 butoirs pour couvercle &
4 butoirs pour lunette

Wood - Forest

| EAN-Nr. no EAN | Artikel Nr. no d'article | Beschreibung description | VPE ce | VE ue | UVP pro Stk. PVC CHF excl. | UVP pro Stk. PVC CHF incl. |
|-------------------|-----------------------------|-----------------------------|-----------|----------|----------------------------------|----------------------------------|
|-------------------|-----------------------------|-----------------------------|-----------|----------|----------------------------------|----------------------------------|

WC-Sitz Forest Slow Down

Siège de WC Forest Slow Down

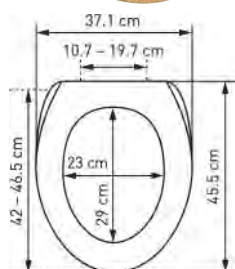

32 1371 97

buche - MDF - FSC® 100%
hêtre - MDF - FSC® 100%
42 - 46.5 x 37.1 cm ; 16

4



78.28

84.31



32 1372 97

eiche sägerau- MDF - FSC®
100%
chêne - MDF - FSC® 100%
42 - 46.5 x 37.1 cm ; 16

4



78.28

84.31



Das Zeichen für verantwortungsvolle Waldwirtschaft
Le produit de la gestion forestière responsable

Ersatzbremse

Frein de remplacement



31 1704 95

verchromt
chromé

1



52.19

56.21

Befestigungsschrauben

Visses de fixation



31 1704 98

16

2



13.42

14.45

Wood - Forest

| EAN-Nr. <i>no EAN</i> | Artikel Nr. <i>no d'article</i> | Beschreibung <i>description</i> | VPE <i>ce</i> | VE <i>ue</i> | UVP pro Stk. <i>PVC</i> CHF excl. | UVP pro Stk. <i>PVC</i> CHF incl. |
|--------------------------|------------------------------------|------------------------------------|------------------|-----------------|---|---|
|--------------------------|------------------------------------|------------------------------------|------------------|-----------------|---|---|

Pufferset

Set butoirs



7 611038 070656

31 1705 91

weiss
blanc
16

1



12.12

13.05



2 Deckelpuffer & 4 Sitzpuffer
2 butoirs pour couvercle &
4 butoirs pour lunette

Wood - Mobello

| EAN-Nr. no EAN | Artikel Nr. no d'article | Beschreibung description | VPE ce | VE ue | UVP pro Stk. PVC CHF excl. | UVP pro Stk. PVC CHF incl. |
|-------------------|-----------------------------|-----------------------------|-----------|----------|----------------------------------|----------------------------------|
|-------------------|-----------------------------|-----------------------------|-----------|----------|----------------------------------|----------------------------------|

WC-Sitz Mobello

Siège de WC Mobello

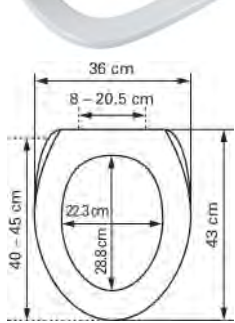

| | | | | | | | |
|---|--|-------------------|--|---|---|---------------|---------------|
|  |  7 611038 009649 | 31 1933 41 | alpinweiss - INOX blanc alpin - INOX 40-45 x 36 cm ; Stift 25 mm | 6 |  | 279.59 | 301.11 |
|---|--|-------------------|--|---|---|---------------|---------------|



aus MDF mit Excenterscharnier
mit Sacklochbefestigung
en MDF avec charnières
excentriques et enfichables



Sacklochscharnier

Charnière enfichable

| | | | | | | | |
|---|--|-------------------|---------------------|---|---|--------------|--------------|
|  |  7 611038 011192 | 31 1930 60 | INOX Stift 28 mm | 1 |  | 50.33 | 54.20 |
|---|--|-------------------|---------------------|---|---|--------------|--------------|

Pufferset

Set butoirs

| | | | | | | | |
|---|--|-------------------|---------------------------|---|---|--------------|--------------|
|  |  8 011456 038037 | 31 1930 66 | alpinweiss blanc alpin | 1 |  | 10.90 | 11.74 |
|---|--|-------------------|---------------------------|---|---|--------------|--------------|









2 Deckelpuffer & 4 Sitzpuffer
2 butoirs pour couvercle &
4 butoirs pour lunette

Wood - KAN 2001

| EAN-Nr. no EAN | Artikel Nr. no d'article | Beschreibung description | VPE ce | VE ue | UVP pro Stk. PVC CHF excl. | UVP pro Stk. PVC CHF incl. |
|-------------------|-----------------------------|-----------------------------|-----------|----------|----------------------------------|----------------------------------|
|-------------------|-----------------------------|-----------------------------|-----------|----------|----------------------------------|----------------------------------|

WC-Sitz mit Holzkern

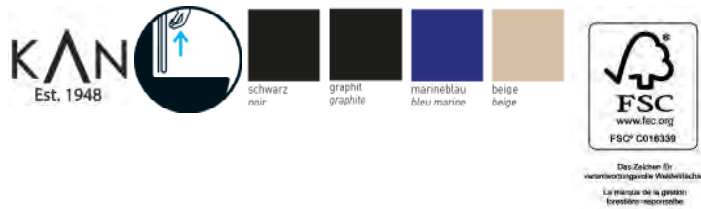

Siège de WC avec noyau en bois

| | | | | | | | |
|---|--|--------------|--|---|---|---------------|---------------|
|  |  7 391160 210556 | 21055 | schwarz - FSC® mix noir - FSC® mix 40-44 x 37 cm | 6 |  | 100.65 | 108.40 |
| |  7 391160 210563 | 21056 | graphit - FSC® mix graphite - FSC® mix 40-44 x 37 cm | 6 |  | 100.65 | 108.40 |
| |  7 391160 213137 | 21313 | marineblau - FSC® mix bleu marine - FSC® mix 40-44 x 37 cm | 6 |  | 100.65 | 108.40 |
| |  7 391160 218927 | 21892 | bahamabeige - FSC® mix beige bahama - FSC® mix 40-44 x 37 cm | 6 |  | 100.65 | 108.40 |





Befestigungsschrauben

Vissés de fixation

| | | | | | | | |
|---|--|-------------------|---------------------------|---|---|--------------|--------------|
|  |  7 611038 013295 | 32 2224 98 | weiss blanc M10 ; 6 | 2 |  | 19.11 | 20.58 |
|---|--|-------------------|---------------------------|---|---|--------------|--------------|

Scharnieroberteil Paar

Pièce supérieure paire

| | | | | | | | |
|---|--|-------------------|--------------|---|---|--------------|--------------|
|  |  7 611038 245481 | 32 2237 94 | grau gris | 1 |  | 16.78 | 18.07 |
|---|--|-------------------|--------------|---|---|--------------|--------------|

zu Kan-Sitzen ohne
Absenkautomatik
pour sièges de WC Kan sans
abaissement automatique

Polypropylen - Arles

| EAN-Nr. no EAN | Artikel Nr. no d'article | Beschreibung description | VPE ce | VE ue | UVP pro Stk. PVC CHF excl. | UVP pro Stk. PVC CHF incl. |
|-------------------|-----------------------------|-----------------------------|-----------|----------|----------------------------------|----------------------------------|
|-------------------|-----------------------------|-----------------------------|-----------|----------|----------------------------------|----------------------------------|

NEW

WC-Sitz Arles mit Absenkautom.

Siège de WC Arles avec freine



31 1718 14

Winter forest
41.5-45.5 x 36.3 cm

5



33.55

36.13

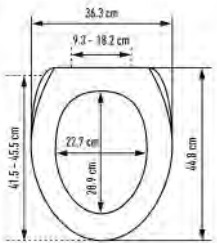

NEW

WC-Sitz Arles mit Absenkautom.

Siège de WC Arles avec freine



31 1718 13

Africa
41.5-45.5 x 36.3 cm

5



33.55

36.13

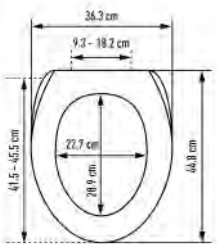

Polypropylen - Arles

| EAN-Nr. no EAN | Artikel Nr. no d'article | Beschreibung description | VPE ce | VE ue | UVP pro Stk. PVC CHF excl. | UVP pro Stk. PVC CHF incl. |
|-------------------|-----------------------------|-----------------------------|-----------|----------|----------------------------------|----------------------------------|
|-------------------|-----------------------------|-----------------------------|-----------|----------|----------------------------------|----------------------------------|

NEW

WC-Sitz Arles mit Absenkautom.

Siège de WC Arles avec freine



31 1718 12

Mountain sea
41.5-45.5 x 36.3 cm

5



33.55

36.13

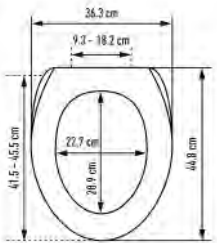

NEW

WC-Sitz Arles mit Absenkautom.

Siège de WC Arles avec freine



31 1718 11

Under the sea
41.5-45.5 x 36.3 cm

5



33.55

36.13

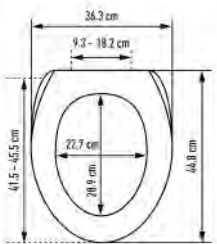

Polypropylen - Arles

| EAN-Nr. <i>no EAN</i> | Artikel Nr. <i>no d'article</i> | Beschreibung <i>description</i> | VPE <i>ce</i> | VE <i>ue</i> | UVP pro Stk. <i>PVC</i> CHF excl. | UVP pro Stk. <i>PVC</i> CHF incl. |
|--------------------------|------------------------------------|------------------------------------|------------------|-----------------|---|---|
|--------------------------|------------------------------------|------------------------------------|------------------|-----------------|---|---|

NEW

WC-Sitz Arles mit Absenkautom.

Siège de WC Arles avec freine



31 1718 10

Graphics
41.5-45.5 x 36.3 cm

5



33.55

36.13

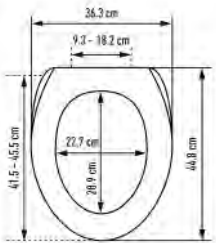

WC-Sitz Arles mit Absenkautom.

Siège de WC Arles avec freine



31 1718 09

Nice day
41.5-45.5 x 36.3 cm

5



34.95

37.64

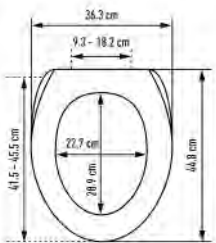

Polypropylen - Arles

| EAN-Nr. no EAN | Artikel Nr. no d'article | Beschreibung description | VPE ce | VE ue | UVP pro Stk. PVC CHF excl. | UVP pro Stk. PVC CHF incl. |
|-------------------|-----------------------------|-----------------------------|-----------|----------|----------------------------------|----------------------------------|
|-------------------|-----------------------------|-----------------------------|-----------|----------|----------------------------------|----------------------------------|

| | | | | | | |
|---------------------------------------|--------------------------------------|--|--|--|--|--|
| WC-Sitz Arles mit Absenkautom. | Siège de WC Arles avec freine | | | | | |
|---------------------------------------|--------------------------------------|--|--|--|--|--|



| | | | | | |
|-------------------|----------------------------------|---|--|--------------|--------------|
| 31 1718 08 | Palm tree 41.5-45.5 x 36.3 cm | 5 | | 34.95 | 37.64 |
|-------------------|----------------------------------|---|--|--------------|--------------|

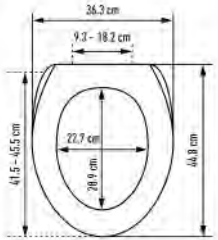

| | | | | | | |
|---------------------------------------|--------------------------------------|--|--|--|--|--|
| WC-Sitz Arles mit Absenkautom. | Siège de WC Arles avec freine | | | | | |
|---------------------------------------|--------------------------------------|--|--|--|--|--|



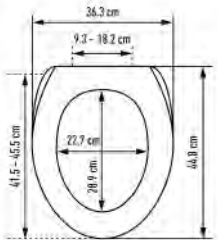

| | | | | | |
|-------------------|-----------------------------|---|--|--------------|--------------|
| 31 1718 07 | Rock 41.5-45.5 x 36.3 cm | 5 | | 34.95 | 37.64 |
|-------------------|-----------------------------|---|--|--------------|--------------|



Polypropylen - Arles



| EAN-Nr. <i>no EAN</i> | Artikel Nr. <i>no d'article</i> | Beschreibung <i>description</i> | VPE <i>ce</i> | VE <i>ue</i> | UVP pro Stk. <i>PVC</i> CHF excl. | UVP pro Stk. <i>PVC</i> CHF incl. |
|--------------------------|------------------------------------|------------------------------------|------------------|-----------------|---|---|
|--------------------------|------------------------------------|------------------------------------|------------------|-----------------|---|---|

| | |
|---------------------------------------|--------------------------------------|
| WC-Sitz Arles mit Absenkautom. | Siège de WC Arles avec freine |
|---------------------------------------|--------------------------------------|

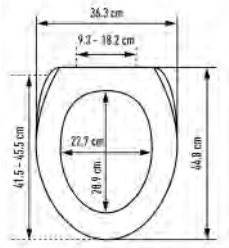
| | | | | | | | |
|---|--|-------------------|----------------------------------|---|---|--------------|--------------|
|  |  7 640141 463529 | 31 1718 05 | Dragonfly 41.5-45.5 x 36.3 cm | 5 |  | 34.95 | 37.64 |
|---|--|-------------------|----------------------------------|---|---|--------------|--------------|



| | |
|---------------------------------------|--------------------------------------|
| WC-Sitz Arles mit Absenkautom. | Siège de WC Arles avec freine |
|---------------------------------------|--------------------------------------|

| | | | | | | | |
|---|--|-------------------|------------------------------|---|---|--------------|--------------|
|  |  7 640141 464175 | 31 1718 04 | Heart 41.5-45.5 x 36.3 cm | 5 |  | 34.95 | 37.64 |
|---|--|-------------------|------------------------------|---|---|--------------|--------------|

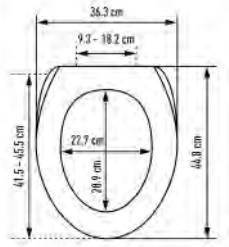

Polypropylen - Arles

| EAN-Nr. <i>no EAN</i> | Artikel Nr. <i>no d'article</i> | Beschreibung <i>description</i> | VPE <i>ce</i> | VE <i>ue</i> | UVP pro Stk. <i>PVC</i> CHF excl. | UVP pro Stk. <i>PVC</i> CHF incl. |
|--------------------------|------------------------------------|------------------------------------|------------------|-----------------|---|---|
|--------------------------|------------------------------------|------------------------------------|------------------|-----------------|---|---|

| | |
|---------------------------------------|--------------------------------------|
| WC-Sitz Arles mit Absenkautom. | Siège de WC Arles avec freine |
|---------------------------------------|--------------------------------------|



31 1718 03

Beachlife
41.5-45.5 x 36.3 cm

5



34.95

37.64

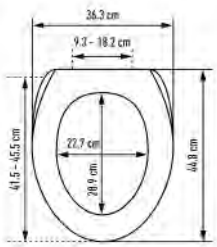

| | |
|---------------------------------|------------------------|
| Befestigungsgarnitur BVO | Jeu de fixation |
|---------------------------------|------------------------|



31 1718 98

3



17.71

19.07

| | |
|------------------|--------------------|
| Pufferset | Set butoirs |
|------------------|--------------------|

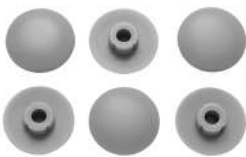

31 1718 96

grau
gris

30



7.27

7.83

2 Deckelpuffer & 4 Sitzpuffer
2 butoirs pour couvercle &
4 butoirs pour lunette

Duroplast - Laval

| EAN-Nr. no EAN | Artikel Nr. no d'article | Beschreibung description | VPE ce | VE ue | UVP pro Stk. PVC CHF excl. | UVP pro Stk. PVC CHF incl. |
|-------------------|-----------------------------|-----------------------------|-----------|----------|----------------------------------|----------------------------------|
|-------------------|-----------------------------|-----------------------------|-----------|----------|----------------------------------|----------------------------------|

| WC-Sitz Laval Slow Down | Siège de WC Laval Slow Down | | | | | |
|-------------------------|-----------------------------|--|--|--|--|--|
|-------------------------|-----------------------------|--|--|--|--|--|



31 1720 01

Chalet
41 - 46 x 36.2 cm ; 11

7



76.42

82.30

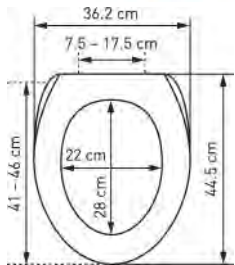

mit Metall-Scharnieren
Ringfarbe: weiss
avec charnières en métal
couleur de la lunette: blanc

| WC-Sitz Laval Slow Down | Siège de WC Laval Slow Down | | | | | |
|-------------------------|-----------------------------|--|--|--|--|--|
|-------------------------|-----------------------------|--|--|--|--|--|



31 1720 03

Aspen
41 - 46 x 36.2 cm ; 11

7



76.42

82.30

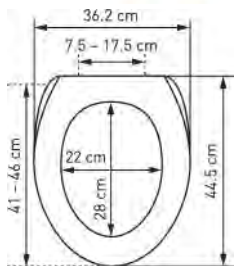

mit Metall-Scharnieren
Ringfarbe: weiss
avec charnières en métal
couleur de la lunette: blanc

Duroplast - Laval

| EAN-Nr. <i>no EAN</i> | Artikel Nr. <i>no d'article</i> | Beschreibung <i>description</i> | VPE <i>ce</i> | VE <i>ue</i> | UVP pro Stk. <i>PVC</i> CHF excl. | UVP pro Stk. <i>PVC</i> CHF incl. |
|--------------------------|------------------------------------|------------------------------------|------------------|-----------------|---|---|
|--------------------------|------------------------------------|------------------------------------|------------------|-----------------|---|---|

| WC-Sitz Laval Slow Down | Siège de WC Laval Slow Down | | | | | |
|-------------------------|-----------------------------|--|--|--|--|--|
|-------------------------|-----------------------------|--|--|--|--|--|



31 1720 04

Sparkling water
41 - 46 x 36.2 cm ; 11

7



76.42

82.30

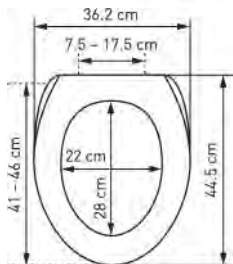

mit Metall-Scharnieren
Ringfarbe: weiss
avec charnières en métal
couleur de la lunette: blanc

| Excenterscharnier Eco | Charnière excentrique Eco | | | | | |
|-----------------------|---------------------------|--|--|--|--|--|
|-----------------------|---------------------------|--|--|--|--|--|



31 1664 96

Nylon - Edelstahl
nylon - inox
11

1



37.28

40.15

| Pufferset | Set butoirs | | | | | |
|-----------|-------------|--|--|--|--|--|
|-----------|-------------|--|--|--|--|--|



33 2105 96

weiss
blanc

1





10.90

11.74

2 Deckelpuffer & 4 Sitzpuffer
2 butoirs pour couvercle &
4 butoirs pour lunette



Duroplast - Nancy

| EAN-Nr. no EAN | Artikel Nr. no d'article | Beschreibung description | VPE ce | VE ue | UVP pro Stk. PVC CHF excl. | UVP pro Stk. PVC CHF incl. |
|-------------------|-----------------------------|-----------------------------|-----------|----------|----------------------------------|----------------------------------|
|-------------------|-----------------------------|-----------------------------|-----------|----------|----------------------------------|----------------------------------|

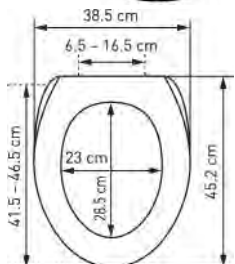
| WC-Sitz Nancy Slow Down | | Siège de WC Nancy Slow Down | | | | | |
|---|--|-----------------------------|--|---|---|--------------|--------------|
|  |  7 611038 171483 | 31 1713 50 | Walk of fame Walk of fame 41.5-46.5 x 38.5 cm ; 33 | 5 |  | 68.96 | 74.27 |



mit Metall-Scharnieren
 Ringfarbe: weiss
 avec charnières en métal
 couleur de la lunette: blanc

| WC-Sitz Nancy Slow Down | | Siège de WC Nancy Slow Down | | | | | |
|---|--|-----------------------------|-------------------------------------|---|---|--------------|--------------|
|  |  7 611038 171490 | 31 1713 51 | Treetop 41.5-46.5 x 38.5 cm ; 14 | 5 |  | 68.96 | 74.27 |

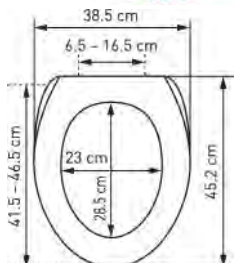

mit Metall-Scharnieren
 Ringfarbe: weiss
 avec charnières en métal
 couleur de la lunette: blanc

Duroplast - Nancy

| EAN-Nr. no EAN | Artikel Nr. no d'article | Beschreibung description | VPE ce | VE ue | UVP pro Stk. PVC CHF excl. | UVP pro Stk. PVC CHF incl. |
|-------------------|-----------------------------|-----------------------------|-----------|----------|----------------------------------|----------------------------------|
|-------------------|-----------------------------|-----------------------------|-----------|----------|----------------------------------|----------------------------------|

| | |
|--------------------------------|------------------------------------|
| WC-Sitz Nancy Slow Down | Siège de WC Nancy Slow Down |
|--------------------------------|------------------------------------|



31 1713 54

Lion
41.5-46.5 x 38.5 cm ; 33

5



68.96

74.27

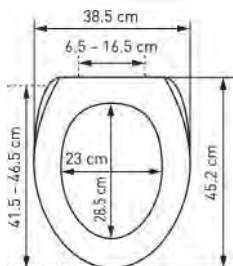

mit Metall-Scharnieren
Ringfarbe: weiss
avec charnières en métal
couleur de la lunette: blanc

| | |
|--------------------------------|------------------------------------|
| WC-Sitz Nancy Slow Down | Siège de WC Nancy Slow Down |
|--------------------------------|------------------------------------|



31 1713 55

Beer
41.5-46.5 x 38.5 cm ; 14

5



68.96

74.27

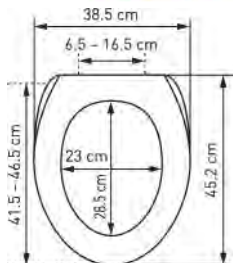

mit Metall-Scharnieren
Ringfarbe: weiss
avec charnières en métal
couleur de la lunette: blanc

Duroplast - Nancy

| EAN-Nr. no EAN | Artikel Nr. no d'article | Beschreibung description | VPE ce | VE ue | UVP pro Stk. PVC CHF excl. | UVP pro Stk. PVC CHF incl. |
|-------------------|-----------------------------|-----------------------------|-----------|----------|----------------------------------|----------------------------------|
|-------------------|-----------------------------|-----------------------------|-----------|----------|----------------------------------|----------------------------------|

| | |
|--------------------------------|------------------------------------|
| WC-Sitz Nancy Slow Down | Siège de WC Nancy Slow Down |
|--------------------------------|------------------------------------|



31 1713 56

Beach chair
41.5-46.5 x 38.5 cm ; 33

5



68.96

74.27

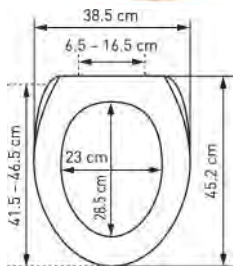

mit Metall-Scharnieren
Ringfarbe: weiss
avec charnières en métal
couleur de la lunette: blanc

| | |
|--------------------------------|------------------------------------|
| WC-Sitz Nancy Slow Down | Siège de WC Nancy Slow Down |
|--------------------------------|------------------------------------|



31 1713 57

Anchor
41.5-46.5 x 38.5 cm ; 33

5



68.96

74.27

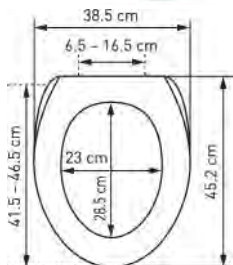

mit Metall-Scharnieren
Ringfarbe: weiss
avec charnières en métal
couleur de la lunette: blanc

Duroplast - Nancy

| | EAN-Nr. <i>no EAN</i> | Artikel Nr. <i>no d'article</i> | Beschreibung <i>description</i> | VPE <i>ce</i> | VE <i>ue</i> | UVP pro Stk. <i>PVC</i> CHF excl. | UVP pro Stk. <i>PVC</i> CHF incl. |
|--|--------------------------|------------------------------------|------------------------------------|------------------|-----------------|---|---|
|--|--------------------------|------------------------------------|------------------------------------|------------------|-----------------|---|---|

Befestigungsgarnitur bis 2020

Jeu de fixation



31 1689 94

14

1



17.71

19.07

Pufferset

Set butoirs



31 1689 96

weiss
blanc
14

1



2 Deckelpuffer & 4 Sitzpuffer
2 butoirs pour couvercle &
4 butoirs pour lunette

Duroplast - Nice

| EAN-Nr. no EAN | Artikel Nr. no d'article | Beschreibung description | VPE ce | VE ue | UVP pro Stk. PVC CHF excl. | UVP pro Stk. PVC CHF incl. |
|-------------------|-----------------------------|-----------------------------|-----------|----------|----------------------------------|----------------------------------|
|-------------------|-----------------------------|-----------------------------|-----------|----------|----------------------------------|----------------------------------|

NEW

WC-Sitz Nice Slow Down

Siège de WC Nice Slow Down



31 1721 01

Racing
42.5 - 46 x 37.5 cm ; 37

5



72.69

78.29

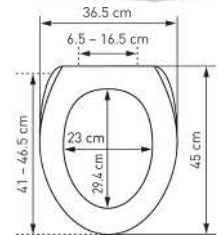

mit Metall-Scharnieren
3-fach bedruckt
avec charnières en métal
imprimé sur 3 côtés

NEW

WC-Sitz Nice Slow Down

Siège de WC Nice Slow Down



31 1712 77

Classico
41 - 46.5 x 36.5 cm ; 2

5



68.96

74.27

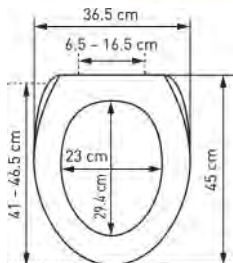

mit Metall-Scharnieren
Ringfarbe: weiss
avec charnières en métal
couleur de la lunette: blanc

Duroplast - Nice

| | | | | | | | |
|--|--------------------------|------------------------------------|------------------------------------|------------------|-----------------|---|---|
| | EAN-Nr. <i>no EAN</i> | Artikel Nr. <i>no d'article</i> | Beschreibung <i>description</i> | VPE <i>ce</i> | VE <i>ue</i> | UVP pro Stk. <i>PVC</i> CHF excl. | UVP pro Stk. <i>PVC</i> CHF incl. |
|--|--------------------------|------------------------------------|------------------------------------|------------------|-----------------|---|---|

NEW

WC-Sitz Nice Slow Down

Siège de WC Nice Slow Down



31 1712 78

Zen Rock
41 - 46.5 x 36.5 cm ; 2

5



68.96

74.27

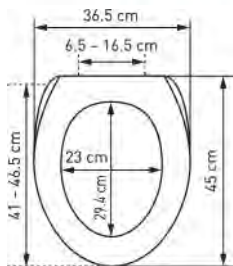

mit Metall-Scharnieren
Ringfarbe: weiss
avec charnières en métal
couleur de la lunette: blanc

NEW

WC-Sitz Nice Slow Down

Siège de WC Nice Slow Down



31 1712 79

Puppy
41 - 46.5 x 36.5 cm ; 2

5



68.96

74.27

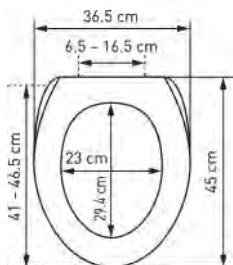

mit Metall-Scharnieren
Ringfarbe: weiss
avec charnières en métal
couleur de la lunette: blanc

Duroplast - Nice

| EAN-Nr. no EAN | Artikel Nr. no d'article | Beschreibung description | VPE ce | VE ue | UVP pro Stk. PVC CHF excl. | UVP pro Stk. PVC CHF incl. |
|-------------------|-----------------------------|-----------------------------|-----------|----------|----------------------------------|----------------------------------|
|-------------------|-----------------------------|-----------------------------|-----------|----------|----------------------------------|----------------------------------|

NEW

WC-Sitz Nice Slow Down

Siège de WC Nice Slow Down



31 1712 80

Zodiac
41 - 46.5 x 36.5 cm ; 2

5



68.96

74.27

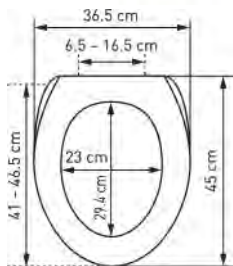

mit Metall-Scharnieren
Ringfarbe: weiss
avec charnières en métal
couleur de la lunette: blanc

NEW

WC-Sitz Nice Slow Down

Siège de WC Nice Slow Down



31 1712 82

Adventure
41 - 46.5 x 36.5 cm ; 2

5



68.96

74.27

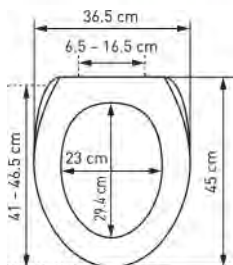

mit Metall-Scharnieren
Ringfarbe: weiss
avec charnières en métal
couleur de la lunette: blanc

Duroplast - Nice

| EAN-Nr. no EAN | Artikel Nr. no d'article | Beschreibung description | VPE ce | VE ue | UVP pro Stk. PVC CHF excl. | UVP pro Stk. PVC CHF incl. |
|-------------------|-----------------------------|-----------------------------|-----------|----------|----------------------------------|----------------------------------|
|-------------------|-----------------------------|-----------------------------|-----------|----------|----------------------------------|----------------------------------|

NEW

WC-Sitz Nice Slow Down

Siège de WC Nice Slow Down



31 1712 83

Mondo
41 - 46.5 x 36.5 cm ; 2

5



68.96

74.27

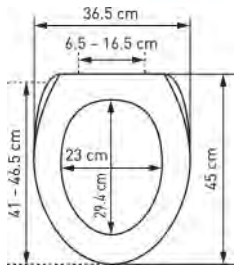

mit Metall-Scharnieren
Ringfarbe: weiss
avec charnières en métal
couleur de la lunette: blanc

WC-Sitz Nice Slow Down

Siège de WC Nice Slow Down



31 1712 75

Edelweiss
41 - 46.5 x 36.5 cm ; 2

5



68.96

74.27

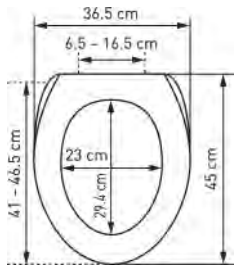



mit Metall-Scharnieren
Ringfarbe: weiss
avec charnières en métal
couleur de la lunette: blanc

Duroplast - Nice

| EAN-Nr. no EAN | Artikel Nr. no d'article | Beschreibung description | VPE ce | VE ue | UVP pro Stk. PVC CHF excl. | UVP pro Stk. PVC CHF incl. |
|-------------------|-----------------------------|-----------------------------|-----------|----------|----------------------------------|----------------------------------|
|-------------------|-----------------------------|-----------------------------|-----------|----------|----------------------------------|----------------------------------|

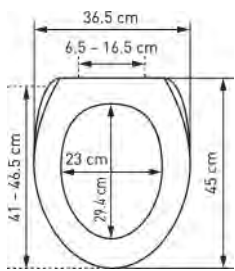
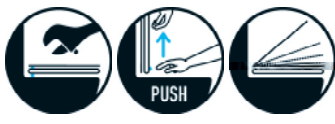

| | |
|-------------------------------|-----------------------------------|
| WC-Sitz Nice Slow Down | Siège de WC Nice Slow Down |
|-------------------------------|-----------------------------------|

| | | | | | | | |
|---|--|-------------------|--|---|---|--------------|--------------|
|  |  7 611038 249946 | 31 1712 76 | Swiss Dream 41 - 46.5 x 36.5 cm ; 2 | 5 |  | 68.96 | 74.27 |
|---|--|-------------------|--|---|---|--------------|--------------|



mit Metall-Scharnieren
Ringfarbe: weiss
*avec charnières en métal
couleur de la lunette: blanc*

| | |
|-------------------------------|-----------------------------------|
| WC-Sitz Nice Slow Down | Siège de WC Nice Slow Down |
|-------------------------------|-----------------------------------|

| | | | | | | | |
|---|--|-------------------|---------------------------------------|---|---|--------------|--------------|
|  |  7 611038 175726 | 31 1712 59 | Ocean love 41 - 46.5 x 36.5 cm ; 2 | 5 |  | 68.96 | 74.27 |
|---|--|-------------------|---------------------------------------|---|---|--------------|--------------|

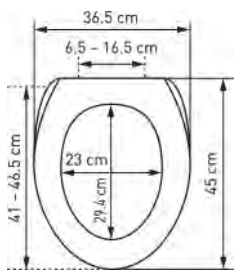

mit Metall-Scharnieren
Ringfarbe: weiss
*avec charnières en métal
couleur de la lunette: blanc*

Duroplast - Nice

| EAN-Nr. <i>no EAN</i> | Artikel Nr. <i>no d'article</i> | Beschreibung <i>description</i> | VPE <i>ce</i> | VE <i>ue</i> | UVP pro Stk. <i>PVC</i> CHF excl. | UVP pro Stk. <i>PVC</i> CHF incl. |
|--------------------------|------------------------------------|------------------------------------|------------------|-----------------|---|---|
|--------------------------|------------------------------------|------------------------------------|------------------|-----------------|---|---|

| | |
|-------------------------------|-----------------------------------|
| WC-Sitz Nice Slow Down | Siège de WC Nice Slow Down |
|-------------------------------|-----------------------------------|



31 1712 61

Flamingo
41 - 46.5 x 36.5 cm ; 2

5



68.96

74.27

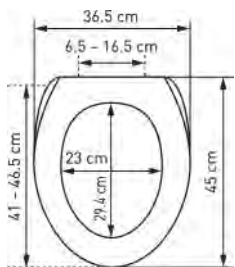

mit Metall-Scharnieren
Ringfarbe: weiss
avec charnières en métal
couleur de la lunette: blanc

| | |
|-------------------------------|-----------------------------------|
| WC-Sitz Nice Slow Down | Siège de WC Nice Slow Down |
|-------------------------------|-----------------------------------|



31 1712 62

Giraffe
41 - 46.5 x 36.5 cm ; 2

5



68.96

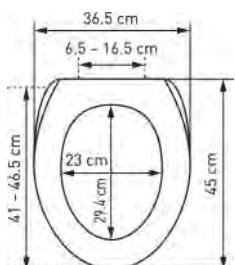

74.27



mit Metall-Scharnieren
Ringfarbe: weiss
avec charnières en métal
couleur de la lunette: blanc



Duroplast - Nice

| EAN-Nr. no EAN | Artikel Nr. no d'article | Beschreibung description | VPE ce | VE ue | UVP pro Stk. PVC CHF excl. | UVP pro Stk. PVC CHF incl. |
|-------------------|-----------------------------|-----------------------------|-----------|----------|----------------------------------|----------------------------------|
|-------------------|-----------------------------|-----------------------------|-----------|----------|----------------------------------|----------------------------------|

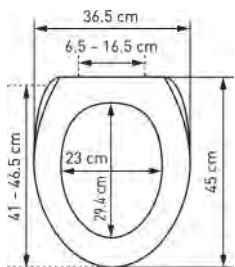
| WC-Sitz Nice Slow Down | | Siège de WC Nice Slow Down | | | | |
|---|--|----------------------------|---|---|---|---------------------------|
|  |  7 611038 175771 | 31 1712 63 | Sea Shell Shell 41 - 46.5 x 36.5 cm ; 2 | 5 |  | 68.96 74.27 |



mit Metall-Scharnieren
Ringfarbe: weiss
avec charnières en métal
couleur de la lunette: blanc

| WC-Sitz Nice Slow Down | | Siège de WC Nice Slow Down | | | | |
|---|--|----------------------------|------------------------------------|---|---|---------------------------|
|  |  7 611038 175788 | 31 1712 64 | Samrita 41 - 46.5 x 36.5 cm ; 2 | 5 |  | 68.96 74.27 |

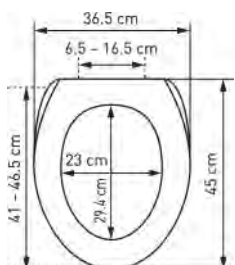

mit Metall-Scharnieren
Ringfarbe: weiss
avec charnières en métal
couleur de la lunette: blanc

Duroplast - Nice

| EAN-Nr. <i>no EAN</i> | Artikel Nr. <i>no d'article</i> | Beschreibung <i>description</i> | VPE <i>ce</i> | VE <i>ue</i> | UVP pro Stk. <i>PVC</i> CHF excl. | UVP pro Stk. <i>PVC</i> CHF incl. |
|--------------------------|------------------------------------|------------------------------------|------------------|-----------------|---|---|
|--------------------------|------------------------------------|------------------------------------|------------------|-----------------|---|---|

| | |
|-------------------------------|-----------------------------------|
| WC-Sitz Nice Slow Down | Siège de WC Nice Slow Down |
|-------------------------------|-----------------------------------|



31 1712 65

Mosaik
41 - 46.5 x 36.5 cm ; 2

5



68.96

74.27

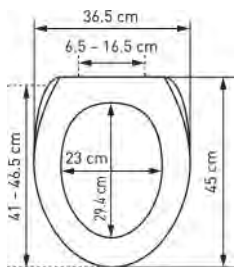

mit Metall-Scharnieren
Ringfarbe: weiss
avec charnières en métal
couleur de la lunette: blanc

| | |
|-------------------------------|-----------------------------------|
| WC-Sitz Nice Slow Down | Siège de WC Nice Slow Down |
|-------------------------------|-----------------------------------|



31 1712 66

Enjoy
41 - 46.5 x 36.5 cm ; 2

5



68.96

74.27

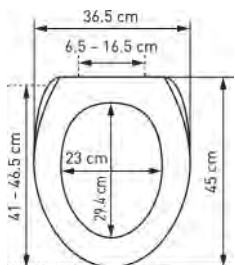

mit Metall-Scharnieren
Ringfarbe: weiss
avec charnières en métal
couleur de la lunette: blanc

Duroplast - Nice

| EAN-Nr. no EAN | Artikel Nr. no d'article | Beschreibung description | VPE ce | VE ue | UVP pro Stk. PVC CHF excl. | UVP pro Stk. PVC CHF incl. |
|-------------------|-----------------------------|-----------------------------|-----------|----------|----------------------------------|----------------------------------|
|-------------------|-----------------------------|-----------------------------|-----------|----------|----------------------------------|----------------------------------|

| | |
|-------------------------------|-----------------------------------|
| WC-Sitz Nice Slow Down | Siège de WC Nice Slow Down |
|-------------------------------|-----------------------------------|



31 1712 67

Sakura
41 - 46.5 x 36.5 cm ; 2

5



68.96

74.27

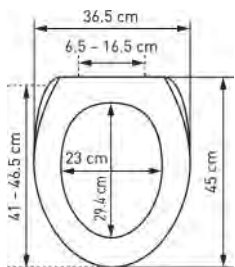

mit Metall-Scharnieren
Ringfarbe: weiss
avec charnières en métal
couleur de la lunette: blanc

| | |
|-------------------------------|-----------------------------------|
| WC-Sitz Nice Slow Down | Siège de WC Nice Slow Down |
|-------------------------------|-----------------------------------|



31 1712 68

Greenery
41 - 46.5 x 36.5 cm ; 2

5



68.96

74.27

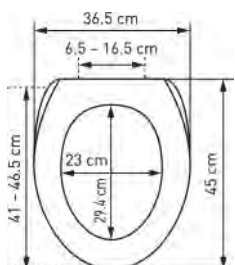

mit Metall-Scharnieren
Ringfarbe: weiss
avec charnières en métal
couleur de la lunette: blanc

Duroplast - Nice

| EAN-Nr. no EAN | Artikel Nr. no d'article | Beschreibung description | VPE ce | VE ue | UVP pro Stk. PVC CHF excl. | UVP pro Stk. PVC CHF incl. |
|-------------------|-----------------------------|-----------------------------|-----------|----------|----------------------------------|----------------------------------|
|-------------------|-----------------------------|-----------------------------|-----------|----------|----------------------------------|----------------------------------|

| | |
|-------------------------------|-----------------------------------|
| WC-Sitz Nice Slow Down | Siège de WC Nice Slow Down |
|-------------------------------|-----------------------------------|

| | | | | | | | |
|--|---------------------|-------------------|---------------------------------|---|--|--------------|--------------|
| | 7 611038 175849 | 31 1712 69 | Cool 41 - 46.5 x 36.5 cm ; 2 | 5 | | 68.96 | 74.27 |
|--|---------------------|-------------------|---------------------------------|---|--|--------------|--------------|

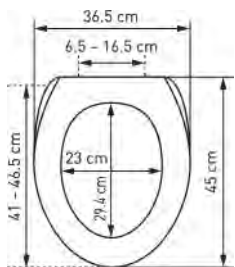

mit Metall-Scharnieren
 Ringfarbe: weiss
 avec charnières en métal
 couleur de la lunette: blanc

| | |
|-------------------------------|-----------------------------------|
| WC-Sitz Nice Slow Down | Siège de WC Nice Slow Down |
|-------------------------------|-----------------------------------|

| | | | | | | | |
|--|---------------------|-------------------|--------------------------------|---|--|--------------|--------------|
| | 7 611038 175856 | 31 1712 70 | Owl 41 - 46.5 x 36.5 cm ; 2 | 5 | | 68.96 | 74.27 |
|--|---------------------|-------------------|--------------------------------|---|--|--------------|--------------|

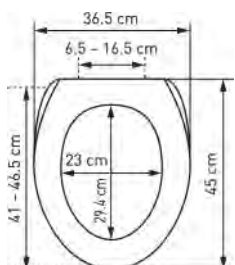



mit Metall-Scharnieren
 Ringfarbe: weiss
 avec charnières en métal
 couleur de la lunette: blanc

Duroplast - Nice

| EAN-Nr. no EAN | Artikel Nr. no d'article | Beschreibung description | VPE ce | VE ue | UVP pro Stk. PVC CHF excl. | UVP pro Stk. PVC CHF incl. |
|-------------------|-----------------------------|-----------------------------|-----------|----------|----------------------------------|----------------------------------|
|-------------------|-----------------------------|-----------------------------|-----------|----------|----------------------------------|----------------------------------|

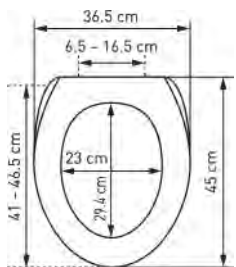

| | |
|-------------------------------|-----------------------------------|
| WC-Sitz Nice Slow Down | Siège de WC Nice Slow Down |
|-------------------------------|-----------------------------------|

| | | | | | | | |
|---|--|------------|------------------------------------|---|---|-------|-------|
|  |  7 611038 175900 | 31 1712 71 | Magical 41 - 46.5 x 36.5 cm ; 2 | 5 |  | 68.96 | 74.27 |
|---|--|------------|------------------------------------|---|---|-------|-------|



mit Metall-Scharnieren
 Ringfarbe: weiss
 avec charnières en métal
 couleur de la lunette: blanc

| | |
|-------------------------------|-----------------------------------|
| WC-Sitz Nice Slow Down | Siège de WC Nice Slow Down |
|-------------------------------|-----------------------------------|

| | | | | | | | |
|---|--|------------|---------------------------------|---|---|-------|-------|
|  |  7 611038 184711 | 31 1712 72 | Lion 41 - 46.5 x 36.5 cm ; 2 | 5 |  | 68.96 | 74.27 |
|---|--|------------|---------------------------------|---|---|-------|-------|

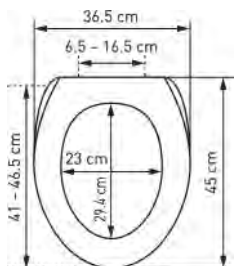



mit Metall-Scharnieren
 Ringfarbe: weiss
 avec charnières en métal
 couleur de la lunette: blanc

Duroplast - Nice

| EAN-Nr. <i>no EAN</i> | Artikel Nr. <i>no d'article</i> | Beschreibung <i>description</i> | VPE <i>ce</i> | VE <i>ue</i> | UVP pro Stk. <i>PVC</i> CHF excl. | UVP pro Stk. <i>PVC</i> CHF incl. |
|--------------------------|------------------------------------|------------------------------------|------------------|-----------------|---|---|
|--------------------------|------------------------------------|------------------------------------|------------------|-----------------|---|---|

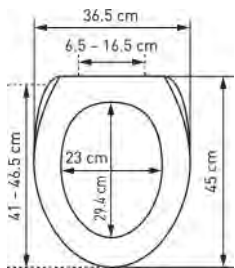

| | |
|-------------------------------|-----------------------------------|
| WC-Sitz Nice Slow Down | Siège de WC Nice Slow Down |
|-------------------------------|-----------------------------------|

| | | | | | | | |
|---|--|------------|--------------------------------------|---|---|-------|-------|
|  |  7 611038 184728 | 31 1712 73 | Frog king 41 - 46.5 x 36.5 cm ; 2 | 5 |  | 68.96 | 74.27 |
|---|--|------------|--------------------------------------|---|---|-------|-------|



mit Metall-Scharnieren
 Ringfarbe: weiss
avec charnières en métal
couleur de la lunette: blanc

| | |
|-------------------------------|-----------------------------------|
| WC-Sitz Nice Slow Down | Siège de WC Nice Slow Down |
|-------------------------------|-----------------------------------|

| | | | | | | | |
|---|--|------------|---------------------------------|---|---|-------|-------|
|  |  7 611038 188672 | 31 1712 74 | Duck 41 - 46.5 x 36.5 cm ; 2 | 5 |  | 68.96 | 74.27 |
|---|--|------------|---------------------------------|---|---|-------|-------|

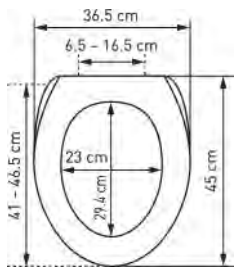

mit Metall-Scharnieren
 Ringfarbe: weiss
avec charnières en métal
couleur de la lunette: blanc

Duroplast - Nice

| EAN-Nr. <i>no EAN</i> | Artikel Nr. <i>no d'article</i> | Beschreibung <i>description</i> | VPE <i>ce</i> | VE <i>ue</i> | UVP pro Stk. <i>PVC</i> CHF excl. | UVP pro Stk. <i>PVC</i> CHF incl. |
|--------------------------|------------------------------------|------------------------------------|------------------|-----------------|---|---|
|--------------------------|------------------------------------|------------------------------------|------------------|-----------------|---|---|

| | |
|-------------------------------|-----------------------------------|
| WC-Sitz Nice Slow Down | Siège de WC Nice Slow Down |
|-------------------------------|-----------------------------------|



31 1712 42

Oops!
41 - 46.5 x 36.5 cm ; 2

5



68.96

74.27

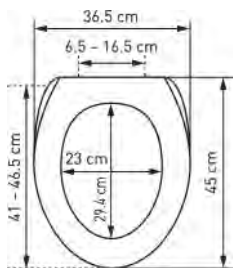

mit Metall-Scharnieren
Ringfarbe: weiss
avec charnières en métal
couleur de la lunette: blanc

| | |
|-------------------------------|-----------------------------------|
| WC-Sitz Nice Slow Down | Siège de WC Nice Slow Down |
|-------------------------------|-----------------------------------|



31 1712 43

Plank
41 - 46.5 x 36.5 cm ; 2

5



68.96

74.27

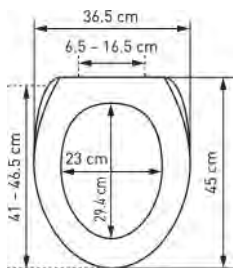

mit Metall-Scharnieren
Ringfarbe: weiss
avec charnières en métal
couleur de la lunette: blanc

Duroplast - Nice

| EAN-Nr. no EAN | Artikel Nr. no d'article | Beschreibung description | VPE ce | VE ue | UVP pro Stk. PVC CHF excl. | UVP pro Stk. PVC CHF incl. |
|-------------------|-----------------------------|-----------------------------|-----------|----------|----------------------------------|----------------------------------|
|-------------------|-----------------------------|-----------------------------|-----------|----------|----------------------------------|----------------------------------|

| WC-Sitz Nice Slow Down | Siège de WC Nice Slow Down | | | | | |
|------------------------|----------------------------|--|--|--|--|--|
|------------------------|----------------------------|--|--|--|--|--|



31 1712 44

Shell
41 - 46.5 x 36.5 cm ; 2

5



68.96

74.27

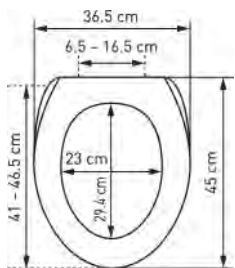

mit Metall-Scharnieren
Ringfarbe: weiss
avec charnières en métal
couleur de la lunette: blanc

| WC-Sitz Nice Slow Down | Siège de WC Nice Slow Down | | | | | |
|------------------------|----------------------------|--|--|--|--|--|
|------------------------|----------------------------|--|--|--|--|--|



31 1712 45

Splash
41 - 46.5 x 36.5 cm ; 2

5



68.96

74.27

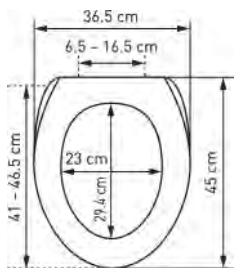



mit Metall-Scharnieren
Ringfarbe: weiss
avec charnières en métal
couleur de la lunette: blanc

Duroplast - Nice

| EAN-Nr. <i>no EAN</i> | Artikel Nr. <i>no d'article</i> | Beschreibung <i>description</i> | VPE <i>ce</i> | VE <i>ue</i> | UVP pro Stk. <i>PVC</i> CHF excl. | UVP pro Stk. <i>PVC</i> CHF incl. |
|--------------------------|------------------------------------|------------------------------------|------------------|-----------------|---|---|
|--------------------------|------------------------------------|------------------------------------|------------------|-----------------|---|---|

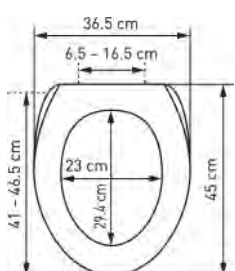

| | |
|-------------------------------|-----------------------------------|
| WC-Sitz Nice Slow Down | Siège de WC Nice Slow Down |
|-------------------------------|-----------------------------------|

| | | | | | | | |
|---|--|-------------------|------------------------------------|---|---|--------------|--------------|
|  |  7 611038 163112 | 31 1712 46 | Animals 41 - 46.5 x 36.5 cm ; 2 | 5 |  | 68.96 | 74.27 |
|---|--|-------------------|------------------------------------|---|---|--------------|--------------|



mit Metall-Scharnieren
 Ringfarbe: weiss
avec charnières en métal
couleur de la lunette: blanc

| | |
|-------------------------------|-----------------------------------|
| WC-Sitz Nice Slow Down | Siège de WC Nice Slow Down |
|-------------------------------|-----------------------------------|

| | | | | | | | |
|---|--|-------------------|-----------------------------------|---|---|--------------|--------------|
|  |  7 611038 163129 | 31 1712 47 | Selfie 41 - 46.5 x 36.5 cm ; 2 | 5 |  | 68.96 | 74.27 |
|---|--|-------------------|-----------------------------------|---|---|--------------|--------------|

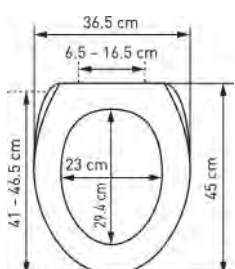



mit Metall-Scharnieren
 Ringfarbe: weiss
avec charnières en métal
couleur de la lunette: blanc

Duroplast - Nice

| | | | | | | |
|--------------------------|------------------------------------|------------------------------------|------------------|-----------------|---|---|
| EAN-Nr. <i>no EAN</i> | Artikel Nr. <i>no d'article</i> | Beschreibung <i>description</i> | VPE <i>ce</i> | VE <i>ue</i> | UVP pro Stk. <i>PVC</i> CHF excl. | UVP pro Stk. <i>PVC</i> CHF incl. |
|--------------------------|------------------------------------|------------------------------------|------------------|-----------------|---|---|

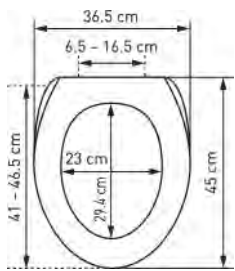

| | |
|-------------------------------|-----------------------------------|
| WC-Sitz Nice Slow Down | Siège de WC Nice Slow Down |
|-------------------------------|-----------------------------------|

| | | | | | | | |
|---|--|-------------------|-------------------------------------|---|---|--------------|--------------|
|  |  7 611038 163167 | 31 1712 50 | Colorful 41 - 46.5 x 36.5 cm ; 2 | 5 |  | 68.96 | 74.27 |
|---|--|-------------------|-------------------------------------|---|---|--------------|--------------|



mit Metall-Scharnieren
Ringfarbe: weiss
avec charnières en métal
couleur de la lunette: blanc

| | |
|-------------------------------|-----------------------------------|
| WC-Sitz Nice Slow Down | Siège de WC Nice Slow Down |
|-------------------------------|-----------------------------------|

| | | | | | | | |
|---|--|-------------------|----------------------------------|---|---|--------------|--------------|
|  |  7 611038 163174 | 31 1712 51 | Beach 41 - 46.5 x 36.5 cm ; 2 | 5 |  | 68.96 | 74.27 |
|---|--|-------------------|----------------------------------|---|---|--------------|--------------|

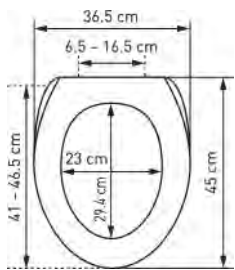



mit Metall-Scharnieren
Ringfarbe: weiss
avec charnières en métal
couleur de la lunette: blanc

Duroplast - Nice

| EAN-Nr. no EAN | Artikel Nr. no d'article | Beschreibung description | VPE ce | VE ue | UVP pro Stk. PVC CHF excl. | UVP pro Stk. PVC CHF incl. |
|-------------------|-----------------------------|-----------------------------|-----------|----------|----------------------------------|----------------------------------|
|-------------------|-----------------------------|-----------------------------|-----------|----------|----------------------------------|----------------------------------|

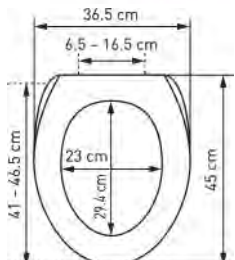
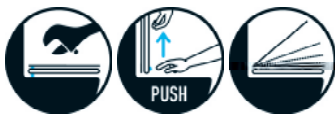

| | |
|-------------------------------|-----------------------------------|
| WC-Sitz Nice Slow Down | Siège de WC Nice Slow Down |
|-------------------------------|-----------------------------------|

| | | | | | | | |
|---|--|-------------------|-----------------------------------|---|---|--------------|--------------|
|  |  7 611038 166380 | 31 1712 55 | Mojito 41 - 46.5 x 36.5 cm ; 2 | 5 |  | 68.96 | 74.27 |
|---|--|-------------------|-----------------------------------|---|---|--------------|--------------|



mit Metall-Scharnieren
 Ringfarbe: weiss
 avec charnières en métal
 couleur de la lunette: blanc

| | |
|-------------------------------|-----------------------------------|
| WC-Sitz Nice Slow Down | Siège de WC Nice Slow Down |
|-------------------------------|-----------------------------------|

| | | | | | | | |
|---|--|-------------------|---------------------------------|---|---|--------------|--------------|
|  |  7 611038 166397 | 31 1712 56 | Frog 41 - 46.5 x 36.5 cm ; 2 | 5 |  | 68.96 | 74.27 |
|---|--|-------------------|---------------------------------|---|---|--------------|--------------|

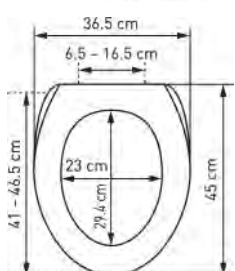



mit Metall-Scharnieren
 Ringfarbe: weiss
 avec charnières en métal
 couleur de la lunette: blanc

Duroplast - Nice

| EAN-Nr. no EAN | Artikel Nr. no d'article | Beschreibung description | VPE ce | VE ue | UVP pro Stk. PVC CHF excl. | UVP pro Stk. PVC CHF incl. |
|-------------------|-----------------------------|-----------------------------|-----------|----------|----------------------------------|----------------------------------|
|-------------------|-----------------------------|-----------------------------|-----------|----------|----------------------------------|----------------------------------|

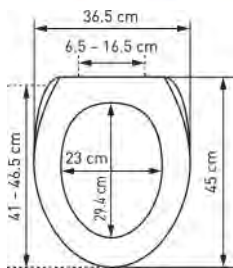

| | |
|-------------------------------|-----------------------------------|
| WC-Sitz Nice Slow Down | Siège de WC Nice Slow Down |
|-------------------------------|-----------------------------------|

| | | | | | | | |
|---|--|-------------------|-----------------------------------|---|---|--------------|--------------|
|  |  7 611038 099046 | 31 1712 01 | Monkey 41 - 46.5 x 36.5 cm ; 2 | 5 |  | 68.96 | 74.27 |
|---|--|-------------------|-----------------------------------|---|---|--------------|--------------|



mit Metall-Scharnieren
Ringfarbe: weiss
*avec charnières en métal
couleur de la lunette: blanc*

| | |
|-------------------------------|-----------------------------------|
| WC-Sitz Nice Slow Down | Siège de WC Nice Slow Down |
|-------------------------------|-----------------------------------|

| | | | | | | | |
|---|--|-------------------|------------------------------------|---|---|--------------|--------------|
|  |  7 611038 099145 | 31 1712 02 | Wuschel 41 - 46.5 x 36.5 cm ; 2 | 5 |  | 68.96 | 74.27 |
|---|--|-------------------|------------------------------------|---|---|--------------|--------------|

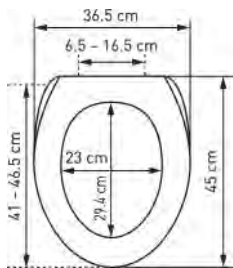



mit Metall-Scharnieren
Ringfarbe: weiss
*avec charnières en métal
couleur de la lunette: blanc*

Duroplast - Nice

| EAN-Nr. no EAN | Artikel Nr. no d'article | Beschreibung description | VPE ce | VE ue | UVP pro Stk. PVC CHF excl. | UVP pro Stk. PVC CHF incl. |
|-------------------|-----------------------------|-----------------------------|-----------|----------|----------------------------------|----------------------------------|
|-------------------|-----------------------------|-----------------------------|-----------|----------|----------------------------------|----------------------------------|

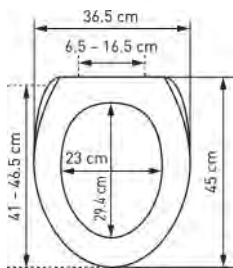

| | |
|-------------------------------|-----------------------------------|
| WC-Sitz Nice Slow Down | Siège de WC Nice Slow Down |
|-------------------------------|-----------------------------------|

| | | | | | | | |
|---|--|-------------------|-----------------------------------|---|---|--------------|--------------|
|  |  7 611038 099107 | 31 1712 03 | Stones 41 - 46.5 x 36.5 cm ; 2 | 5 |  | 68.96 | 74.27 |
|---|--|-------------------|-----------------------------------|---|---|--------------|--------------|



mit Metall-Scharnieren
 Ringfarbe: weiss
*avec charnières en métal
 couleur de la lunette: blanc*

| | |
|-------------------------------|-----------------------------------|
| WC-Sitz Nice Slow Down | Siège de WC Nice Slow Down |
|-------------------------------|-----------------------------------|

| | | | | | | | |
|---|--|-------------------|---------------------------------|---|---|--------------|--------------|
|  |  7 611038 099091 | 31 1712 04 | Rose 41 - 46.5 x 36.5 cm ; 2 | 5 |  | 68.96 | 74.27 |
|---|--|-------------------|---------------------------------|---|---|--------------|--------------|

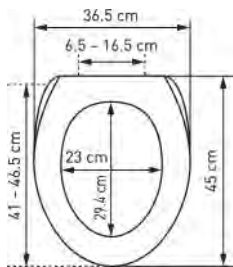



mit Metall-Scharnieren
 Ringfarbe: weiss
*avec charnières en métal
 couleur de la lunette: blanc*

Duroplast - Nice

| EAN-Nr. no EAN | Artikel Nr. no d'article | Beschreibung description | VPE ce | VE ue | UVP pro Stk. PVC CHF excl. | UVP pro Stk. PVC CHF incl. |
|-------------------|-----------------------------|-----------------------------|-----------|----------|----------------------------------|----------------------------------|
|-------------------|-----------------------------|-----------------------------|-----------|----------|----------------------------------|----------------------------------|

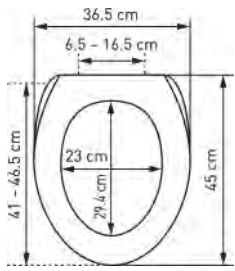

| | |
|-------------------------------|-----------------------------------|
| WC-Sitz Nice Slow Down | Siège de WC Nice Slow Down |
|-------------------------------|-----------------------------------|

| | | | | | | | |
|---|--|-------------------|--------------------------------|---|---|--------------|--------------|
|  |  7 611038 098940 | 31 1712 07 | Cow 41 - 46.5 x 36.5 cm ; 2 | 5 |  | 68.96 | 74.27 |
|---|--|-------------------|--------------------------------|---|---|--------------|--------------|



mit Metall-Scharnieren
Ringfarbe: weiss
avec charnières en métal
couleur de la lunette: blanc

| | |
|-------------------------------|-----------------------------------|
| WC-Sitz Nice Slow Down | Siège de WC Nice Slow Down |
|-------------------------------|-----------------------------------|

| | | | | | | | |
|---|--|-------------------|----------------------------------|---|---|--------------|--------------|
|  |  7 611038 098971 | 31 1712 10 | Fides 41 - 46.5 x 36.5 cm ; 2 | 5 |  | 68.96 | 74.27 |
|---|--|-------------------|----------------------------------|---|---|--------------|--------------|

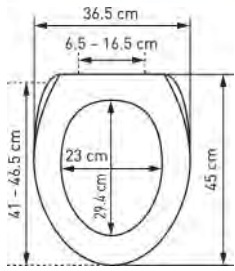

mit Metall-Scharnieren
Ringfarbe: weiss
avec charnières en métal
couleur de la lunette: blanc

Duroplast - Nice

| EAN-Nr. no EAN | Artikel Nr. no d'article | Beschreibung description | VPE ce | VE ue | UVP pro Stk. PVC CHF excl. | UVP pro Stk. PVC CHF incl. |
|-------------------|-----------------------------|-----------------------------|-----------|----------|----------------------------------|----------------------------------|
|-------------------|-----------------------------|-----------------------------|-----------|----------|----------------------------------|----------------------------------|

| | |
|-------------------------------|-----------------------------------|
| WC-Sitz Nice Slow Down | Siège de WC Nice Slow Down |
|-------------------------------|-----------------------------------|



31 1712 13

Palm
41 - 46.5 x 36.5 cm ; 2

5



68.96

74.27

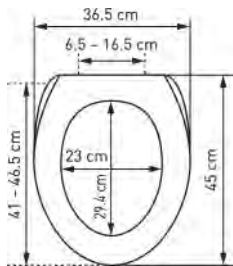

mit Metall-Scharnieren
Ringfarbe: weiss
avec charnières en métal
couleur de la lunette: blanc

| | |
|-------------------------------|-----------------------------------|
| WC-Sitz Nice Slow Down | Siège de WC Nice Slow Down |
|-------------------------------|-----------------------------------|



31 1712 29

Jumping fish
41 - 46.5 x 36.5 cm ; 2

5



68.96

74.27

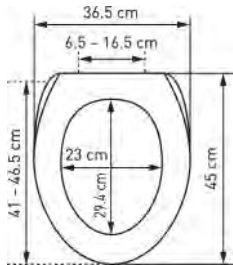



mit Metall-Scharnieren
Ringfarbe: weiss
avec charnières en métal
couleur de la lunette: blanc

Duroplast - Nice

| EAN-Nr. no EAN | Artikel Nr. no d'article | Beschreibung description | VPE ce | VE ue | UVP pro Stk. PVC CHF excl. | UVP pro Stk. PVC CHF incl. |
|-------------------|-----------------------------|-----------------------------|-----------|----------|----------------------------------|----------------------------------|
|-------------------|-----------------------------|-----------------------------|-----------|----------|----------------------------------|----------------------------------|

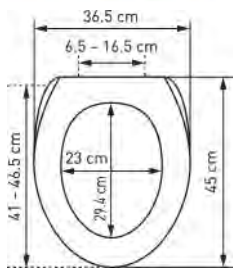

| | |
|-------------------------------|-----------------------------------|
| WC-Sitz Nice Slow Down | Siège de WC Nice Slow Down |
|-------------------------------|-----------------------------------|

| | | | | | | | |
|---|--|-------------------|--------------------------------|---|---|--------------|--------------|
|  |  7 611038 099237 | 31 1712 35 | Loo 41 - 46.5 x 36.5 cm ; 2 | 5 |  | 68.96 | 74.27 |
|---|--|-------------------|--------------------------------|---|---|--------------|--------------|



mit Metall-Scharnieren
 Ringfarbe: weiss
*avec charnières en métal
 couleur de la lunette: blanc*

| | |
|-------------------------------|-----------------------------------|
| WC-Sitz Nice Slow Down | Siège de WC Nice Slow Down |
|-------------------------------|-----------------------------------|

| | | | | | | | |
|---|--|-------------------|------------------------------------|---|---|--------------|--------------|
|  |  7 611038 099190 | 31 1712 32 | Skyline 41 - 46.5 x 36.5 cm ; 2 | 5 |  | 68.96 | 74.27 |
|---|--|-------------------|------------------------------------|---|---|--------------|--------------|

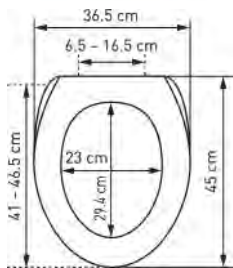



mit Metall-Scharnieren
 Ringfarbe: weiss
*avec charnières en métal
 couleur de la lunette: blanc*

Duroplast - Nice

| EAN-Nr. no EAN | Artikel Nr. no d'article | Beschreibung description | VPE ce | VE ue | UVP pro Stk. PVC CHF excl. | UVP pro Stk. PVC CHF incl. |
|-------------------|-----------------------------|-----------------------------|-----------|----------|----------------------------------|----------------------------------|
|-------------------|-----------------------------|-----------------------------|-----------|----------|----------------------------------|----------------------------------|

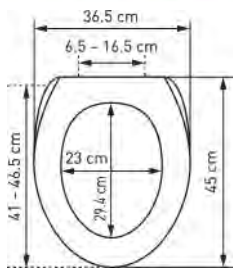

| WC-Sitz Nice Slow Down | | Siège de WC Nice Slow Down | | | | |
|------------------------|--|----------------------------|--|--|--|--|
|------------------------|--|----------------------------|--|--|--|--|

| | | | | | | | |
|---|--|-------------------|-------------------------------------|---|---|--------------|--------------|
|  |  7 611038 099244 | 31 1712 36 | Sixties 41 - 46.5 x 36.5 cm ; 37 | 5 |  | 68.96 | 74.27 |
|---|--|-------------------|-------------------------------------|---|---|--------------|--------------|



mit Metall-Scharnieren
Ringfarbe: weiss
avec charnières en métal
couleur de la lunette: blanc

| WC-Sitz Nice Slow Down | | Siège de WC Nice Slow Down | | | | |
|------------------------|--|----------------------------|--|--|--|--|
|------------------------|--|----------------------------|--|--|--|--|

| | | | | | | | |
|---|--|-------------------|-----------------------------------|---|---|--------------|--------------|
|  |  7 611038 099251 | 31 1712 37 | On/Off 41 - 46.5 x 36.5 cm ; 2 | 5 |  | 68.96 | 74.27 |
|---|--|-------------------|-----------------------------------|---|---|--------------|--------------|

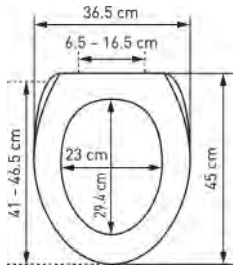

mit Metall-Scharnieren
Ringfarbe: weiss
avec charnières en métal
couleur de la lunette: blanc

Duroplast - Nice

| EAN-Nr. <i>no EAN</i> | Artikel Nr. <i>no d'article</i> | Beschreibung <i>description</i> | VPE <i>ce</i> | VE <i>ue</i> | UVP pro Stk. <i>PVC</i> CHF excl. | UVP pro Stk. <i>PVC</i> CHF incl. |
|--------------------------|------------------------------------|------------------------------------|------------------|-----------------|---|---|
|--------------------------|------------------------------------|------------------------------------|------------------|-----------------|---|---|

Befestigungsgarnitur neu

Jeu de fixation nouveau



31 1644 98

ab 2016
dès 2016
2

2



18.64

20.07

Pufferset

Set butoirs



31 1712 94

weiss
blanc
2

1



12.02

12.95



2 Deckelpuffer & 4 Sitzpuffer
2 butoirs pour couvercle &
4 butoirs pour lunette

Wood - Menton Slow Down

| EAN-Nr. <i>no EAN</i> | Artikel Nr. <i>no d'article</i> | Beschreibung <i>description</i> | VPE <i>ce</i> | VE <i>ue</i> | UVP pro Stk. <i>PVC</i> CHF excl. | UVP pro Stk. <i>PVC</i> CHF incl. |
|--------------------------|------------------------------------|------------------------------------|------------------|-----------------|---|---|
|--------------------------|------------------------------------|------------------------------------|------------------|-----------------|---|---|

WC-Sitz Menton LED Slow Down

Siège WC Menton LED Slow Down

| | | | | | | | |
|---|--|-------------------|--|---|---|---------------|---------------|
|  |  7 611038 188894 | 31 1715 60 | Elephant - MDF - FSC® 100% 41.9 - 46.6 x 36.5 cm ; 36 | 4 |  | 132.34 | 142.53 |
|---|--|-------------------|--|---|---|---------------|---------------|

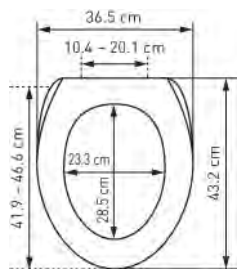
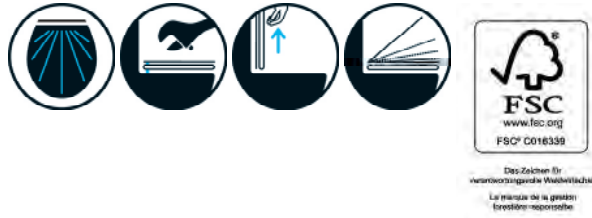

mit Metall-Scharnieren
Ringfarbe: weiss
avec charnières en métal
couleur de la lunette: blanc

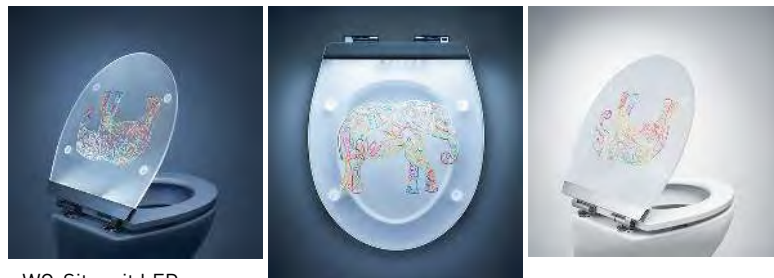



- WC-Sitz mit LED Leuchten
- Licht schaltet durch Audiosensor und nur bei Dunkelheit ein und leuchtet ca. 30 Sekunden
- Funktioniert mittels Batterien (3 x Typ AAA, LR03, 1.5V, nicht im Packungsinhalt)

- *Siège de WC avec lamp LED*
- *L'éclairage de la lumière est déclenché par un détecteur de signal sonore et uniquement dans le noir et reste allumé 30 secondes environ*
- *Fonctionne avec des piles (3 x type AAA, LR03, 1.5V, non comprises dans la livraison)*

Wood - Menton Slow Down

| | | | | | | |
|--------------------------|------------------------------------|------------------------------------|------------------|-----------------|---|---|
| EAN-Nr. <i>no EAN</i> | Artikel Nr. <i>no d'article</i> | Beschreibung <i>description</i> | VPE <i>ce</i> | VE <i>ue</i> | UVP pro Stk. <i>PVC</i> CHF excl. | UVP pro Stk. <i>PVC</i> CHF incl. |
|--------------------------|------------------------------------|------------------------------------|------------------|-----------------|---|---|

| WC-Sitz Menton LED Slow Down | | Siège WC Menton LED Slow Down | | | | | |
|---|--|-------------------------------|--|---|---|---------------|---------------|
|  |  7 611038 760854 | 31 1715 61 | Night beach - MDF - FSC® 100% 41.9 - 46.6 x 36.5 cm ; 36 | 4 |  | 132.34 | 142.53 |

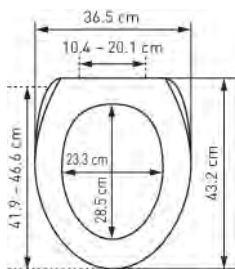
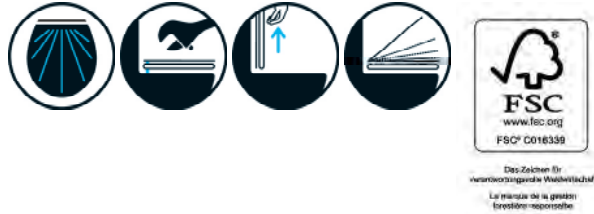

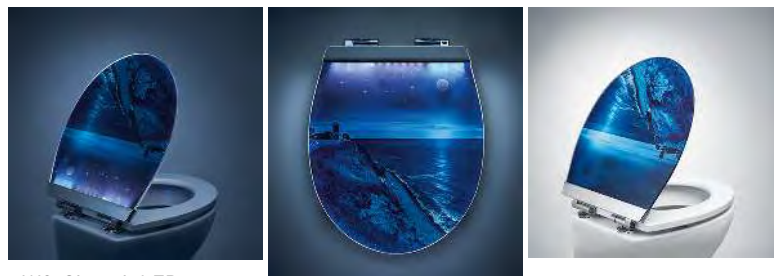

mit Metall-Scharnieren
Ringfarbe: weiss
avec charnières en métal
couleur de la lunette: blanc



- WC-Sitz mit LED Leuchten
- Licht schaltet durch Audiosensor und nur bei Dunkelheit ein und leuchtet ca. 30 Sekunden
- Funktioniert mittels Batterien (3 x Typ AAA, LR03, 1.5V, nicht im Packungsinhalt)
- *Siège de WC avec lamp LED*
- *L'éclairage de la lumière est déclenché par un détecteur de signal sonore et uniquement dans le noir et reste allumé 30 secondes environ*
- *Fonctionne avec des piles (3 x type AAA, LR03, 1.5V, non comprises dans la livraison)*

Wood - Menton Slow Down

| | | | | | | |
|--------------------------|------------------------------------|------------------------------------|------------------|-----------------|---|---|
| EAN-Nr. <i>no EAN</i> | Artikel Nr. <i>no d'article</i> | Beschreibung <i>description</i> | VPE <i>ce</i> | VE <i>ue</i> | UVP pro Stk. <i>PVC</i> CHF excl. | UVP pro Stk. <i>PVC</i> CHF incl. |
|--------------------------|------------------------------------|------------------------------------|------------------|-----------------|---|---|

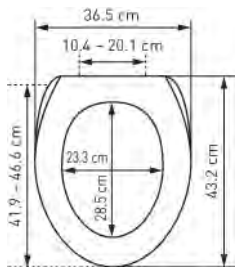
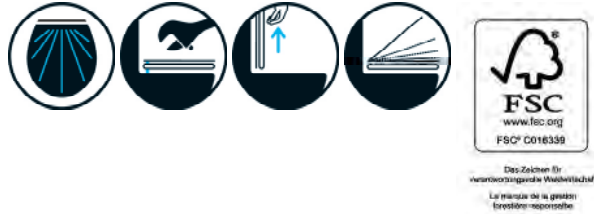

| WC-Sitz Menton LED Slow Down | | Siège WC Menton LED Slow Down | | | | |
|---|--|-------------------------------|---|---|---|-----------------------------|
|  |  7 611038 760861 | 31 1715 62 | weiss - MDF - FSC® 100% <i>blanc - MDF - FSC® 100%</i> 41.9 - 46.6 x 36.5 cm ; 36 | 4 |  | 132.34 142.53 |

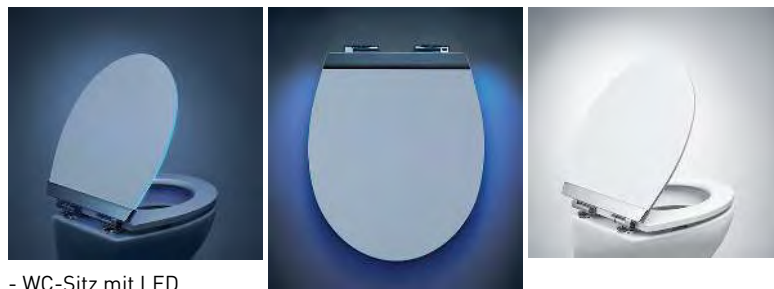

mit Metall-Scharnieren
Ringfarbe: weiss
avec charnières en métal
couleur de la lunette: blanc



- WC-Sitz mit LED Leuchten
- Licht schaltet durch Audiosensor und nur bei Dunkelheit ein und leuchtet ca. 30 Sekunden
- Funktioniert mittels Batterien (3 x Typ AAA, LR03, 1.5V, nicht im Packungsinhalt)
- *Siège de WC avec lamp LED*
- *L'éclairage de la lumière est déclenché par un détecteur de signal sonore et uniquement dans le noir et reste allumé 30 secondes environ*
- *Fonctionne avec des piles (3 x type AAA, LR03, 1.5V, non comprises dans la livraison)*

| Befestigungsgarnitur | | Jeu de fixation | | | | |
|---|--|-------------------|----|---|---|---------------------------|
|  |  7 611038 760878 | 31 1715 94 | 36 | 1 |  | 35.41 38.14 |

Wood - Menton Slow Down

| | EAN-Nr. <i>no EAN</i> | Artikel Nr. <i>no d'article</i> | Beschreibung <i>description</i> | VPE <i>ce</i> | VE <i>ue</i> | UVP pro Stk. <i>PVC</i> CHF excl. | UVP pro Stk. <i>PVC</i> CHF incl. |
|--|--------------------------|------------------------------------|------------------------------------|------------------|-----------------|---|---|
|--|--------------------------|------------------------------------|------------------------------------|------------------|-----------------|---|---|

Pufferset

Set butoirs



31 1715 96

weiss
blanc
36

1



11.74

12.65

4 Deckelpuffer & 4 Sitzpuffer
4 butoirs pour couvercle &
4 butoirs pour lunette

Batterieabdeckung

Couvercle de la batterie



31 1715 95

weiss
blanc
36

1





11.74

12.65



Wood - Brillant

| EAN-Nr. <i>no EAN</i> | Artikel Nr. <i>no d'article</i> | Beschreibung <i>description</i> | VPE <i>ce</i> | VE <i>ue</i> | UVP pro Stk. <i>PVC</i> CHF excl. | UVP pro Stk. <i>PVC</i> CHF incl. |
|--------------------------|------------------------------------|------------------------------------|------------------|-----------------|---|---|
|--------------------------|------------------------------------|------------------------------------|------------------|-----------------|---|---|

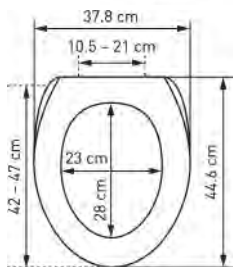
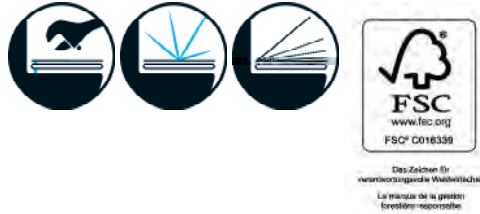
| WC-Sitz Brillant Slow Down | | Siège WC Brillant Slow Down | | | | | |
|---|--|-----------------------------|--|---|---|---------------|---------------|
|  |  7 611038 161941 | 31 1717 10 | Kaleidoscope - MDF - FSC® 100% 42 - 47 x 37.8 cm | 4 |  | 105.31 | 113.42 |



mit Metall-Scharnieren
Ringfarbe: weiss
avec charnières en métal
couleur de la lunette: blanc

| WC-Sitz Brillant Slow Down | | Siège WC Brillant Slow Down | | | | | |
|---|--|-----------------------------|--|---|---|---------------|---------------|
|  |  7 611038 139070 | 31 1717 00 | VIP - MDF - FSC® 100% 42 - 47 x 37.8 cm | 4 |  | 105.31 | 113.42 |

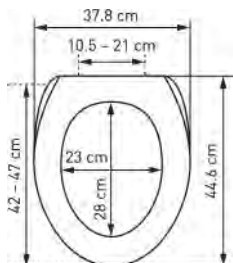
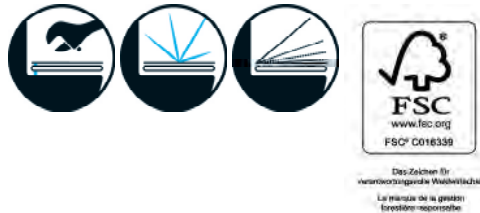



mit Metall-Scharnieren
Ringfarbe: schwarz
avec charnières en métal
couleur de la lunette: noir

Wood - Brillant

| EAN-Nr. <i>no EAN</i> | Artikel Nr. <i>no d'article</i> | Beschreibung <i>description</i> | VPE <i>ce</i> | VE <i>ue</i> | UVP pro Stk. <i>PVC</i> CHF excl. | UVP pro Stk. <i>PVC</i> CHF incl. |
|--------------------------|------------------------------------|------------------------------------|------------------|-----------------|---|---|
|--------------------------|------------------------------------|------------------------------------|------------------|-----------------|---|---|

WC-Sitz Brillant Slow Down

Siège WC Brillant Slow Down

| | | | | | | | |
|---|--|-------------------|--|---|---|---------------|---------------|
|  |  7 611038 139087 | 31 1717 01 | Lotus - MDF - FSC® 100% 42 - 47 x 37.8 cm | 4 |  | 105.31 | 113.42 |
|---|--|-------------------|--|---|---|---------------|---------------|



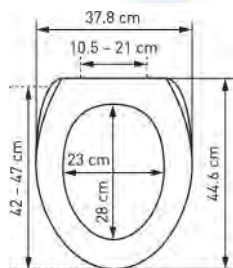

Das Zeichen für verantwortungsvolle Waldwirtschaft
La marque de la gestion forestière responsable



mit Metall-Scharnieren
Ringfarbe: weiss
avec charnières en métal
couleur de la lunette: blanc



Ersatzbremse

Frein de remplacement





| | | | | | | | |
|---|--|-------------------|---------------------------------|---|---|--------------|--------------|
|  |  7 611038 095840 | 31 1710 95 | verchromt <i>chromé</i> 3 | 1 |  | 52.19 | 56.21 |
|---|--|-------------------|---------------------------------|---|---|--------------|--------------|

Befestigungsgarnitur

Jeu de fixation

| | | | | | | | |
|---|--|-------------------|---|---|---|--------------|--------------|
|  |  7 611038 098162 | 31 1710 98 | 3 | 2 |  | 13.42 | 14.45 |
|---|--|-------------------|---|---|---|--------------|--------------|

Wood - Brillant

| | EAN-Nr. <i>no EAN</i> | Artikel Nr. <i>no d'article</i> | Beschreibung <i>description</i> | VPE <i>ce</i> | VE <i>ue</i> | UVP pro Stk. <i>PVC</i> CHF excl. | UVP pro Stk. <i>PVC</i> CHF incl. |
|---|--|------------------------------------|------------------------------------|------------------|---|---|---|
| Pufferset | | Set butoirs | | | | | |
|  |  7 611038 098148 | 31 1710 96 | weiss <i>blanc</i> 3 | 1 |  | 11.65 | 12.55 |
| |  7 611038 139803 | 31 1710 92 | schwarz <i>noir</i> 3 | 1 |  | 11.65 | 12.55 |

2 Deckelpuffer & 4 Sitzpuffer
 2 *butoirs pour couvercle* &
 4 *butoirs pour lunette*

Wood - Paris 3D

| EAN-Nr. <i>no EAN</i> | Artikel Nr. <i>no d'article</i> | Beschreibung <i>description</i> | VPE <i>ce</i> | VE <i>ue</i> | UVP pro Stk. <i>PVC CHF excl.</i> | UVP pro Stk. <i>PVC CHF incl.</i> |
|--------------------------|------------------------------------|------------------------------------|------------------|-----------------|--|--|
|--------------------------|------------------------------------|------------------------------------|------------------|-----------------|--|--|

WC-Sitz Paris 3D Slow Down

Siège WC Paris 3D Slow Down



31 1710 10

Tiger - MDF - FSC® 100%
42 - 47 x 37.2 cm

4



105.31

113.42



Das Zeichen für verantwortungsvolle Waldwirtschaft
Le märke de la gestion forestière responsable

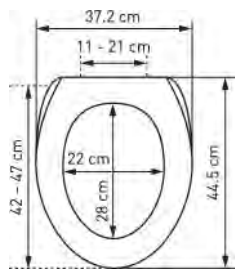

mit Metall-Scharnieren
Ringfarbe: schwarz
*avec charnières en métal
couleur de la lunette: noir*

WC-Sitz Paris 3D Slow Down

Siège WC Paris 3D Slow Down



31 1710 01

Frog - MDF - FSC® 100%
42 - 47 x 37.2 cm

4



105.31

113.42



Das Zeichen für verantwortungsvolle Waldwirtschaft
Le märke de la gestion forestière responsable

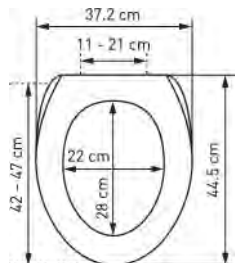



mit Metall-Scharnieren
Ringfarbe: grün
*avec charnières en métal
couleur de la lunette: vert*

Wood - Paris 3D

| EAN-Nr. <i>no EAN</i> | Artikel Nr. <i>no d'article</i> | Beschreibung <i>description</i> | VPE <i>ce</i> | VE <i>ue</i> | UVP pro Stk. <i>PVC</i> CHF excl. | UVP pro Stk. <i>PVC</i> CHF incl. |
|--------------------------|------------------------------------|------------------------------------|------------------|-----------------|---|---|
|--------------------------|------------------------------------|------------------------------------|------------------|-----------------|---|---|

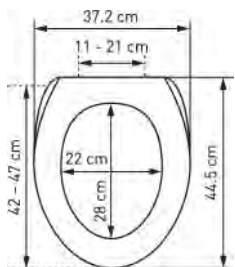

| WC-Sitz Paris 3D Slow Down | Siège WC Paris 3D Slow Down | | | | | |
|----------------------------|-----------------------------|--|--|--|--|--|
|----------------------------|-----------------------------|--|--|--|--|--|

| | | | | | | | |
|---|--|------------|---|---|---|--------|--------|
|  |  7 611038 098124 | 31 1710 12 | Wave - MDF - FSC® 100% 42 - 47 x 37.2 cm | 4 |  | 105.31 | 113.42 |
|---|--|------------|---|---|---|--------|--------|



mit Metall-Scharnieren
 Ringfarbe: türkis
avec charnières en métal
couleur de la lunette: turquoise





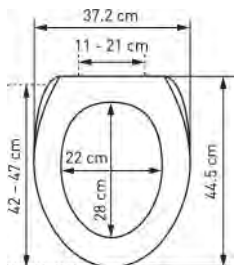





| WC-Sitz Paris 3D Slow Down | Siège WC Paris 3D Slow Down | | | | | |
|----------------------------|-----------------------------|--|--|--|--|--|
|----------------------------|-----------------------------|--|--|--|--|--|

| | | | | | | | |
|---|--|------------|--|---|---|--------|--------|
|  |  7 611038 098117 | 31 1710 11 | Web - MDF - FSC® 100% 42 - 47 x 37.2 cm | 4 |  | 105.31 | 113.42 |
|---|--|------------|--|---|---|--------|--------|



mit Metall-Scharnieren
 Ringfarbe: schwarz
avec charnières en métal
couleur de la lunette: noir

Wood - Paris 3D

| | EAN-Nr. <i>no EAN</i> | Artikel Nr. <i>no d'article</i> | Beschreibung <i>description</i> | VPE <i>ce</i> | VE <i>ue</i> | UVP pro Stk. <i>PVC</i> CHF excl. | UVP pro Stk. <i>PVC</i> CHF incl. |
|---|---|------------------------------------|------------------------------------|------------------|---|---|---|
| Ersatzbremse | | Frein de remplacement | | | | | |
|  |  | 31 1710 95 | verchromt <i>chromé</i> 3 | 1 |  | 52.19 | 56.21 |
| Befestigungsgarnitur | | Jeu de fixation | | | | | |
|  |  | 31 1710 98 | 3 | 2 |  | 13.42 | 14.45 |
| Pufferset | | Set butoirs | | | | | |
|  |  | 31 1710 96 | weiss <i>blanc</i> 3 | 1 |  | 11.65 | 12.55 |
| |  | 31 1710 92 | schwarz <i>noir</i> 3 | 1 |  | 11.65 | 12.55 |

2 Deckelpuffer & 4 Sitzpuffer
2 butoirs pour couvercle &
4 butoirs pour lunette

Wood - Lyon

| EAN-Nr. <i>no EAN</i> | Artikel Nr. <i>no d'article</i> | Beschreibung <i>description</i> | VPE <i>ce</i> | VE <i>ue</i> | UVP pro Stk. <i>PVC</i> CHF excl. | UVP pro Stk. <i>PVC</i> CHF incl. |
|--------------------------|------------------------------------|------------------------------------|------------------|-----------------|---|---|
|--------------------------|------------------------------------|------------------------------------|------------------|-----------------|---|---|

WC-Sitz Lyon Slow Down

Siège de WC Lyon Slow Down



31 1715 01

Lime - MDF - FSC® 100%
42 - 47 x 37.8 cm

4



105.31

113.42



Das Zeichen für
verantwortungsvolle Waldwirtschaft!
Le miracle de la gestion
forestière responsable

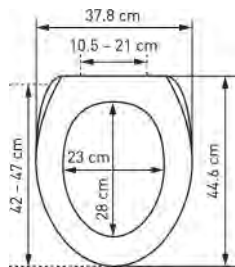

mit Metall-Scharnieren
Ringfarbe: weiss
avec charnières en métal
couleur de la lunette: blanc

WC-Sitz Lyon Slow Down

Siège de WC Lyon Slow Down



31 1715 03

Black sofa - MDF - FSC® 100%
42 - 47 x 37.8 cm

4



105.31

113.42



Das Zeichen für
verantwortungsvolle Waldwirtschaft!
Le miracle de la gestion
forestière responsable

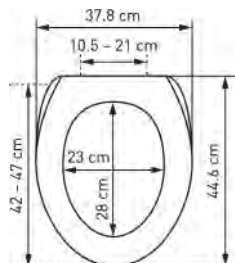

mit Metall-Scharnieren
Ringfarbe: schwarz
avec charnières en métal
couleur de la lunette: noir

Wood - Lyon

| EAN-Nr. no EAN | Artikel Nr. no d'article | Beschreibung description | VPE ce | VE ue | UVP pro Stk. PVC CHF excl. | UVP pro Stk. PVC CHF incl. |
|-------------------|-----------------------------|-----------------------------|-----------|----------|----------------------------------|----------------------------------|
|-------------------|-----------------------------|-----------------------------|-----------|----------|----------------------------------|----------------------------------|

WC-Sitz Lyon Slow Down

Siège de WC Lyon Slow Down



31 1715 04

Kiss - MDF - FSC® 100%
42 - 47 x 37.8 cm

4



105.31

113.42

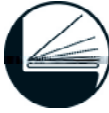

Das Zeichen für verantwortungsvolle Waldwirtschaft
La marque de la gestion forestière responsable

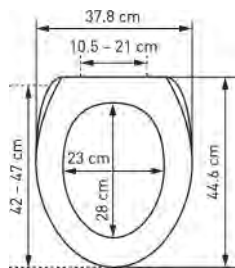

mit Metall-Scharnieren
Ringfarbe: weiss
avec charnières en métal
couleur de la lunette: blanc

WC-Sitz Lyon Slow Down

Siège de WC Lyon Slow Down



31 1715 05

Rattan - MDF - FSC® 100%
42 - 47 x 37.8 cm

4



105.31

113.42



Das Zeichen für verantwortungsvolle Waldwirtschaft
La marque de la gestion forestière responsable

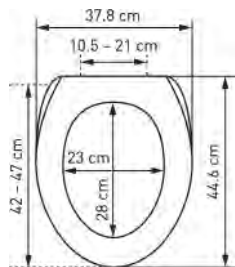

mit Metall-Scharnieren
Ringfarbe: schwarz
avec charnières en métal
couleur de la lunette: noir

Wood - Lyon

| | EAN-Nr. <i>no EAN</i> | Artikel Nr. <i>no d'article</i> | Beschreibung <i>description</i> | VPE <i>ce</i> | VE <i>ue</i> | UVP pro Stk. <i>PVC</i> CHF excl. | UVP pro Stk. <i>PVC</i> CHF incl. |
|--|--------------------------|------------------------------------|------------------------------------|------------------|-----------------|---|---|
|--|--------------------------|------------------------------------|------------------------------------|------------------|-----------------|---|---|

Ersatzbremse

Frein de remplacement



31 1710 95

verchromt
chromé
3

1



52.19

56.21

Befestigungsgarnitur

Jeu de fixation



31 1710 98

3

2



13.42

14.45

Pufferset

Set butoirs



31 1710 96

weiss
blanc
3

1



11.65

12.55



31 1710 92

schwarz
noir
3

1





11.65

12.55

2 Deckelpuffer & 4 Sitzpuffer
2 butoirs pour couvercle &
4 butoirs pour lunette

Zubehör Accessoires

| | EAN-Nr. <i>no EAN</i> | Artikel Nr. <i>no d'article</i> | Beschreibung <i>description</i> | VPE <i>ce</i> | VE <i>ue</i> | UVP pro Stk. <i>PVC</i> CHF excl. | UVP pro Stk. <i>PVC</i> CHF incl. |
|---|---|-------------------------------------|-------------------------------------|------------------|---|---|---|
| WC-Sitz Montageschlüssel | | Clé pour montage siège de WC | | | | | |
|  |  | 31 1780 01 | kunststoff grau <i>plastique</i> | 1 |  | 22.83 | 24.59 |

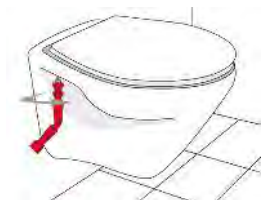

- Flexibel und gelenkig
- Leichte Montage
- Komfortabel und effizient
- Für nahezu alle WC-Sitz Befestigungen
- *Flexible et articulée*
- *Montage simple*
- *Prise en main confortable et efficace*
- *S'adapte à la plus parts des fixation siège WC*



























































**Brausen,
Brauseschläuche
und Zubehör**
*Poignées,
flexibles de
douche et
accessoires*

Kapitel 6 - Inhaltsverzeichnis

Chapitre 6 - Sommaire

| | |
|---|-------|
| Exclusive Duschbrausen <i>Poignées de douche Exclusive</i> | 6.6 |
| Swissline Duschbrausen <i>Poignées de douche Swissline</i> | 6.13 |
| Laufen Duschbrausen <i>Poignées de douche Laufen</i> | 6.18 |
| Ecobooster Duschbrausen <i>Poignées de douche Ecobooster</i> | 6.22 |
| LED Duschbrausen <i>Poignées de douche avec lumière</i> | 6.23 |
| Shower Duschbrausen 1-Strahl <i>Poignées de douche Shower 1 jet</i> | 6.24 |
| Shower Duschbrausen 3-Strahl <i>Poignées de douche Shower 3 jets</i> | 6.32 |
| Shower Duschbrausen 5-Strahl <i>Poignées de douche Shower 5 jets</i> | 6.39 |
| Shower Duschbrausen 8-Strahl <i>Poignées de douche Shower 8 jets</i> | 6.42 |
| Shower Brausegarnituren <i>Garnitures de douche Shower</i> | 6.43 |
| Shower Kopfbrausen <i>Pommes de douche Shower</i> | 6.47 |
| CHROMALUX® ZERO <i>CHROMALUX® ZERO</i> | 6.49 |
| Shower Kunststoffschläuche <i>Flexibles en plastique Shower</i> | 6.52 |
| Shower Metallschläuche <i>Flexibles en métal Shower</i> | 6.55 |
| KWC Gleitstangen <i>Glissières de douche KWC</i> | 6.57 |
| Shower Gleitstangen <i>Glissières de douche Shower</i> | 6.58 |
| Duschsysteme Turn <i>Systèmes de douche Turn</i> | 6.63 |
| Duschsysteme Push <i>Systèmes de douche Turn</i> | 6.77 |
| Duschsysteme <i>Systèmes de douche</i> | 6.84 |
| Duschpaneele <i>Colonnes de douche</i> | 6.103 |
| Gartendusche <i>Douche à jardin</i> | 6.105 |
| My Water Flow Control Dusche <i>My Water Flow Control pour la douche</i> | 6.108 |
| Mengenregler für die Dusche <i>Régulateurs de débit pour la douche</i> | 6.109 |
| Dusch- und Badthermometer <i>Thermomètre de douche et bain</i> | 6.112 |
| Shower Zubehör <i>Accessoires Shower</i> | 6.113 |

Erklärung der Piktogramme Explication des pictogrammes

| | | | | | | | |
|---|---|---|--|--|---|--|---|
|  Vollstrahl Jet plein |  Zentralstrahl Jet central |  Rundumstrahl Jet périphérique |  Softstrahl Jet doux |  Regenstrahl Jet pluie |  Nebelstrahl Jet de brume |  Turbostrahl Jet turbo |  Vitalstrahl Jet vitalité |
|  Champagnerstrahl Jet pétillant |  Brausestrahl Jet de douchette |  Gemischter Strahl Jet mixte |  Schwallstrahl Jet remous |  Hard Rain Pluie à verse |  Sparfunktion Fonction économie |  Kalkentfernung Suppression du calcaire |  Veredelung Finition de surface |
|  EcoBOOSTER EcoBOOSTER | | | | | | | |
|  Vollstrahl Jet plein |  Zentralstrahl Jet central |  Rundumstrahl Jet périphérique |  Regenstrahl Jet pluie |  Nebelstrahl Jet de brume |  Schwallstrahl Jet remous |  Kalkentfernung Suppression du calcaire | |
|  Vollstrahl Jet plein |  Zentralstrahl Jet central |  Kalkentfernung Suppression du calcaire | | | | | |
|  Metal Fix Metal Fix |  5 Jahre Garantie Garantie 5 ans |  10 Jahre Garantie Garantie 10 ans |  Made in Switzerland Fabriqué en Suisse |  Massagedüsen Buse de massage |  Nicht bohren Ne pas percer |  Winkel 45° Angle de 45° |  Strahl mit Luft Jet d'air |
|  Smart Use Smart Use |  Flow Control Flow Control |  Temperaturanzeige Indicateur de température |  LED 7-farbig LED 7 couleurs | | | | |
|  Umsteller Turn Inverseur Turn |  Umsteller Push Inverseur Push |  Umsteller Up/Down Inverseur Up/Down |  Umsteller Palea Inverseur Palea | | | | |
|  Halb-Zoll-Anschluss Raccord demi-pouce |  Verdrehsicherung Raccord anti-torsion |  Kugeldrehkonus Raccord pivotant à bille |  Reissfest Résistant à l'arrachement |  Ultraleicht Ultra léger |  Hochflexibel Extrêmement flexible |  Softe Oberfläche Surface douce |  Separates Innenrohr Tube intérieur séparé |
|  Trinkwasserkonform Conforme aux normes |  Nachhaltig und recyclebar Durable et recyclable |  PVC-frei sans PVC | | | | | |



Duschbrausen

Poignées de douche

Kalkentfernung



Dank den Noppen an der Brause können Kalkablagerungen ganz einfach mit dem Finger entfernt werden.

Grâce aux picots de la douchette, les dépôts de calcaire s'enlèvent très facilement avec le doigt. de jets différents.

Smart Use

Smart Use



Die Strahlarten der besonders bedienfreundlichen Brausen lassen sich einfach per Knopfdruck oder mithilfe eines Drehreglers umstellen.

Les types de jets des douches particulièrement faciles à utiliser peuvent être modifiés par simple pression sur un bouton ou à l'aide d'une molette.

Strahl mit Luft

Jet d'air

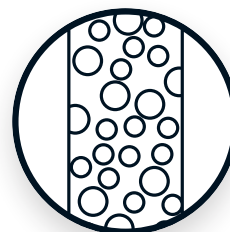

Da der Brausestrahl mit Luft vermischt wird, wird dieser weicher, fülliger und leichter, was ein angenehmes Duschgefühl garantiert. Reduziert den Wasser- und Energieverbrauch.

Comme le jet de douche est mélangé à l'air, il devient plus doux, plus plein et plus léger, ce qui garantit une sensation de douche agréable. Réduit la consommation d'eau et d'énergie.

LED 7-farbig

LED 7 couleurs



Die Brausen mit LED-Funktion leuchten alternierend in sieben Farben oder wahlweise einfarbig. Funktionieren ohne Batterie, da die Brausen mit einem integrierten Generator ausgestattet sind.

Les douches avec fonction LED s'allument en alternance en sept couleurs ou, au choix, en une seule couleur. Fonctionnent sans pile, car elles sont équipées d'un générateur intégré.

Ecobooster

Ecobooster



Mit einem Knopfdruck kann ganz einfach zwischen einem Spar- und Normalwasserstrahl umgestellt werden. Diese Brausen sind zum Wassersparen ideal.

Une simple pression sur un bouton permet de passer facilement d'un jet économique à un jet normal. Ces douchettes sont idéales pour économiser de l'eau.

Temperaturanzeige

Indicateur de température

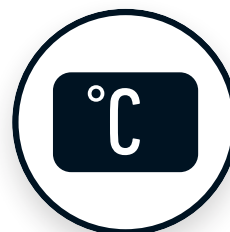

Dank der digitalen Anzeige kann die Temperatur des Wasserstrahls jederzeit kontrolliert werden. Funktioniert mittels Wasserdruck und ohne Batterien.

Grâce à l'affichage numérique, la température du jet d'eau peut être contrôlée à tout moment. Fonctionne par pression d'eau et sans piles.

EXCLUSIVE

EXCLUSIVE



Die EXCLUSIVE Duschbrausen sind komplett in der Schweiz hergestellt und garantieren eine hochwertige Qualität.

Les douches EXCLUSIVE sont entièrement fabriquées en Suisse et garantissent une qualité supérieure.

Energieklasse

Classe énergétique



Je höher der Buchstabe im Alphabet, desto energieeffizienter ist die Duschbrause. Der Energieverbrauch hängt von der Wassermenge ab, welche die Brause durchlässt.

Plus la lettre est élevée dans l'alphabet, plus la douchette est efficace sur le plan énergétique. La consommation d'énergie dépend de la quantité d'eau que la douchette laisse passer.

Trinkwasserkonform

Conforme à l'eau potable





Erfüllen Trinkwasseranforderungen.

Conforme aux exigences en matière d'eau potable.

Exklusive Duschbrausen



Poignées de douche Exclusive

| EAN-Nr. no EAN | Artikel Nr. no d'article | Beschreibung description | VPE ce | VE ue | UVP pro Stk. PVC CHF excl. | UVP pro Stk. PVC CHF incl. |
|-------------------|-----------------------------|-----------------------------|-----------|----------|----------------------------------|----------------------------------|
|-------------------|-----------------------------|-----------------------------|-----------|----------|----------------------------------|----------------------------------|

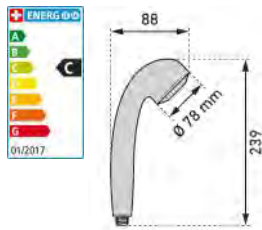
| Duschbrause Baronessa | Poignée de douche Baronessa | | | | | | |
|---|--|------------|---|---|---|-------|-------|
|  |  7 611038 369521 | 09 5000 97 | verchromt chromé 1/2" / 1 Strahl/Jet ; EK: C / ~ 10 l/min | 3 |  | 28.42 | 30.61 |



Erfüllt
Trinkwasseranforderungen
Conforme aux exigences en
matière d'eau potable

| Duschbrause Baronessa | Poignée de douche Baronessa | | | | | | |
|---|--|------------|--|---|---|-------|-------|
|  |  7 611038 369538 | 09 5001 97 | verchromt - Verstellring grau chromé-anneau gris 1/2" / 3 Strahl/Jets ; EK: C / ~ 10 l/min | 3 |  | 33.08 | 35.63 |

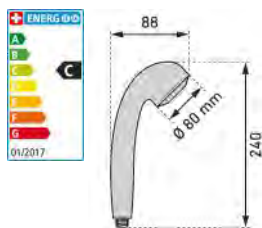



Erfüllt
Trinkwasseranforderungen
Conforme aux exigences en
matière d'eau potable

Exklusive Duschbrausen



Poignées de douche Exclusive

| EAN-Nr. no EAN | Artikel Nr. no d'article | Beschreibung description | VPE ce | VE ue | UVP pro Stk. PVC CHF excl. | UVP pro Stk. PVC CHF incl. |
|-------------------|-----------------------------|-----------------------------|-----------|----------|----------------------------------|----------------------------------|
|-------------------|-----------------------------|-----------------------------|-----------|----------|----------------------------------|----------------------------------|

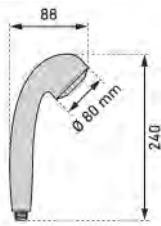
| Duschbrause Baronessa Ghiera | | Poignée douche Baroness Ghiera | | | | |
|---|-------------------|--|---|---|--------------|--------------|
|  | 09 5002 97 | verchromt - Verstellring chrom <i>chromé-anneau chromé</i> 1/2" / 3 Strahl/Jets ; EK: C / ~ 10 l/min | 1 |  | 44.73 | 48.18 |



Erfüllt
Trinkwasseranforderungen
*Conforme aux exigences en
matière d'eau potable*

| Duschbrause Duchessa | | Poignée de douche Duchessa | | | | |
|---|-------------------|---|---|---|--------------|--------------|
|  | 09 5003 97 | verchromt <i>chromé</i> 1/2" / 1 Strahl/Jet ; EK: C / ~ 10 l/min | 3 |  | 28.42 | 30.61 |

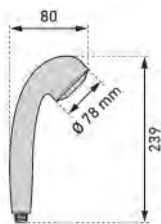



Erfüllt
Trinkwasseranforderungen
*Conforme aux exigences en
matière d'eau potable*

Exklusive Duschbrausen



Poignées de douche Exclusive

| EAN-Nr. no EAN | Artikel Nr. no d'article | Beschreibung description | VPE ce | VE ue | UVP pro Stk. PVC CHF excl. | UVP pro Stk. PVC CHF incl. |
|-------------------|-----------------------------|-----------------------------|-----------|----------|----------------------------------|----------------------------------|
|-------------------|-----------------------------|-----------------------------|-----------|----------|----------------------------------|----------------------------------|

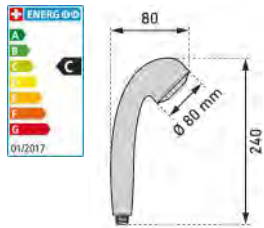
| Duschbrause Duchessa | | Poignée de douche Duchessa | | | | |
|---|--|----------------------------|---|---|---|---------------------------|
|  |  7 611038 369552 | 09 5004 97 | verchromt - Verstellring grau chromé-anneau gris 1/2" / 3 Strahl/Jets ; EK: C / ~ 10 l/min | 3 |  | 33.08 35.63 |



Erfüllt
Trinkwasseranforderungen
Conforme aux exigences en
matière d'eau potable

| Duschbrause Duchessa Ghiera | | Poignée douche Duchessa Ghiera | | | | |
|---|--|--------------------------------|---|---|---|---------------------------|
|  |  7 611038 369576 | 09 5005 97 | verchromt - Verstellring chrom chromé-anneau chromé 1/2" / 3 Strahl/Jets ; EK: C / ~ 10 l/min | 1 |  | 44.73 48.18 |

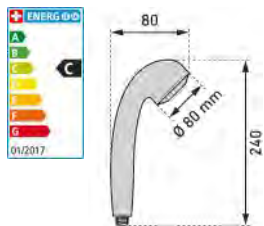



Erfüllt
Trinkwasseranforderungen
Conforme aux exigences en
matière d'eau potable

Exklusive Duschbrausen



Poignées de douche Exclusive

| EAN-Nr. no EAN | Artikel Nr. no d'article | Beschreibung description | VPE ce | VE ue | UVP pro Stk. PVC CHF excl. | UVP pro Stk. PVC CHF incl. |
|-------------------|-----------------------------|-----------------------------|-----------|----------|----------------------------------|----------------------------------|
|-------------------|-----------------------------|-----------------------------|-----------|----------|----------------------------------|----------------------------------|

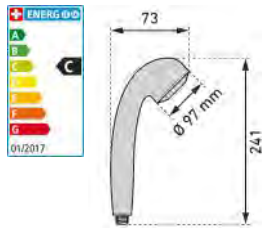
| Duschbrause Concentric | Poignée de douche Concentric | | | | | | |
|---|--|------------|---|---|---|-------|-------|
|  |  7 611038 369583 | 09 5006 97 | verchromt chromé 1/2" / 1 Strahl/Jet ; EK: C / ~ 10 l/min | 1 |  | 39.61 | 42.66 |



Erfüllt
Trinkwasseranforderungen
Conforme aux exigences en
matière d'eau potable

| Duschbrause Concentric | Poignée de douche Concentric | | | | | | |
|---|--|------------|--|---|---|-------|-------|
|  |  7 611038 369590 | 09 5007 97 | verchromt chromé 1/2" / 3 Strahl/Jets ; EK: C / ~ 10 l/min | 1 |  | 54.05 | 58.22 |

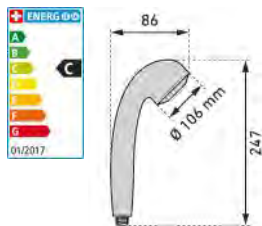



Erfüllt
Trinkwasseranforderungen
Conforme aux exigences en
matière d'eau potable

Exklusive Duschbrausen



Poignées de douche Exclusive

| EAN-Nr. no EAN | Artikel Nr. no d'article | Beschreibung description | VPE ce | VE ue | UVP pro Stk. PVC CHF excl. | UVP pro Stk. PVC CHF incl. |
|-------------------|-----------------------------|-----------------------------|-----------|----------|----------------------------------|----------------------------------|
|-------------------|-----------------------------|-----------------------------|-----------|----------|----------------------------------|----------------------------------|

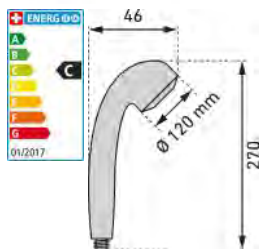
| Duschbrause Tabit | | Poignée de douche Tabit | | | | | |
|---|--|-------------------------|--|---|---|-------|--------|
|  |  7 611038 187941 | 09 5011 97 | schwarz matt noir mat 1/2" / 3 Strahl/Jets ; EK: C / ~ 10 l/min | 3 |  | 99.72 | 107.40 |



Erfüllt
Trinkwasseranforderungen
Conforme aux exigences en
matière d'eau potable

| Duschbrause Aria 100 | | Poignée de douche Aria 100 | | | | | |
|---|--|----------------------------|--|---|---|-------|-------|
|  |  7 611038 162962 | 09 5008 97 | verchromt chromé 1/2" / 1 Strahl/Jet ; EK: C / ~ 10 l/min | 1 |  | 49.39 | 53.20 |

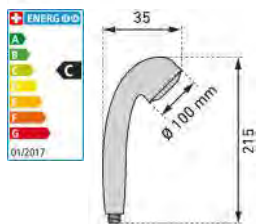
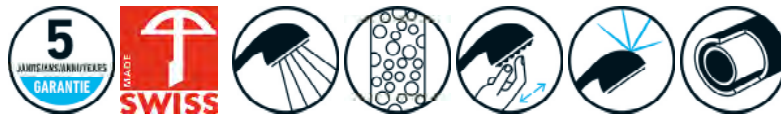



Erfüllt
Trinkwasseranforderungen
Conforme aux exigences en
matière d'eau potabl

Exklusive Duschbrausen

Poignées de douche Exclusive

| EAN-Nr. no EAN | Artikel Nr. no d'article | Beschreibung description | VPE ce | VE ue | UVP pro Stk. PVC CHF excl. | UVP pro Stk. PVC CHF incl. |
|-------------------|-----------------------------|-----------------------------|-----------|----------|----------------------------------|----------------------------------|
|-------------------|-----------------------------|-----------------------------|-----------|----------|----------------------------------|----------------------------------|

Duschbrause Aria 120 Poignée de douche Aria 120

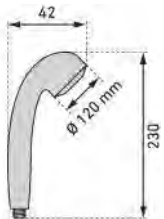

| | | | | | | | |
|---|--|-------------------|---|---|---|--------------|--------------|
|  |  7 611038 162979 | 09 5009 97 | verchromt chromé 1/2" / 3 Strahl/Jets ; EK: C / ~ 10 l/min | 3 |  | 89.47 | 96.36 |
|---|--|-------------------|---|---|---|--------------|--------------|

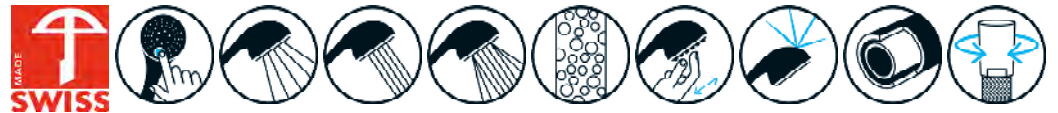

Erfüllt
Trinkwasseranforderungen
Conforme aux exigences en
matière d'eau potabl



Duschbrause Aria 140 Poignée de douche Aria 140

| | | | | | | | |
|---|--|-------------------|---|---|---|--------------|---------------|
|  |  7 611038 162986 | 09 5010 97 | verchromt chromé 1/2" / 3 Strahl/Jets ; EK: C / ~ 10 l/min | 1 |  | 99.72 | 107.40 |
|---|--|-------------------|---|---|---|--------------|---------------|

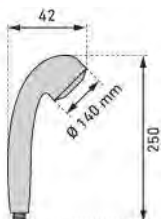

Erfüllt
Trinkwasseranforderungen
Conforme aux exigences en
matière d'eau potable

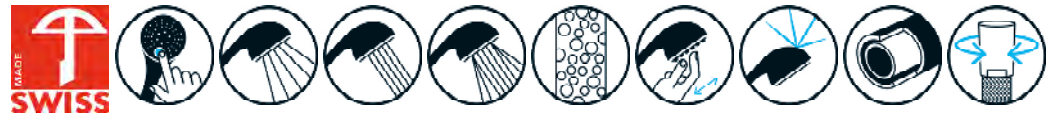



Exclusive Duschbrausen

Poignées de douche Exclusive

| EAN-Nr. no EAN | Artikel Nr. no d'article | Beschreibung description | VPE ce | VE ue | UVP pro Stk. PVC CHF excl. | UVP pro Stk. PVC CHF incl. |
|-------------------|-----------------------------|-----------------------------|-----------|----------|----------------------------------|----------------------------------|
|-------------------|-----------------------------|-----------------------------|-----------|----------|----------------------------------|----------------------------------|

| Duschgleitstange Zermatt | Glissière de douche Zermatt | | | | | |
|--------------------------|-----------------------------|--|--|--|--|--|
|--------------------------|-----------------------------|--|--|--|--|--|

| | | | | | | | |
|---|--|-------------------|---|---|---|--------------|--------------|
|  |  7 611038 099794 | 09 5150 97 | verchromt <i>chromé</i> 70 cm ; Ø 22 mm | 1 |  | 74.56 | 80.30 |
|---|--|-------------------|---|---|---|--------------|--------------|

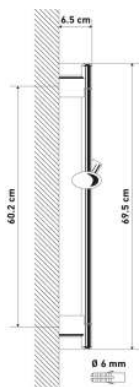



Swissline Brausen

Poignées de douches Swissline

| EAN-Nr. no EAN | Artikel Nr. no d'article | Beschreibung description | VPE ce | VE ue | UVP pro Stk. PVC CHF excl. | UVP pro Stk. PVC CHF incl. |
|-------------------|-----------------------------|-----------------------------|-----------|----------|----------------------------------|----------------------------------|
|-------------------|-----------------------------|-----------------------------|-----------|----------|----------------------------------|----------------------------------|

Duschbrause FIT-E easy

Poignée de douche FIT-E easy

| | | | | | | | |
|---|---|-------------------|--|---|---|--------------|--------------|
|  |  | 09 2128 97 | verchromt chromé 1/2" / 1 Strahl/Jet | 1 |  | 27.96 | 30.11 |
|---|---|-------------------|--|---|---|--------------|--------------|



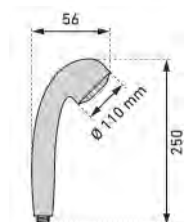

KWC
Swiss Water Experience



Erfüllt
Trinkwasseranforderungen
Conforme aux exigences en
matière d'eau potable

Duschbrause Fit-S

Poignée de douche Fit-S

| | | | | | | | |
|---|---|-------------------|--|---|---|--------------|--------------|
|  |  | 09 2111 98 | verchromt chromé 1/2" / 1 Strahl/Jet ; EK: D / 12 l/min | 3 |  | 54.05 | 58.22 |
|---|---|-------------------|--|---|---|--------------|--------------|



KWC
Swiss Water Experience

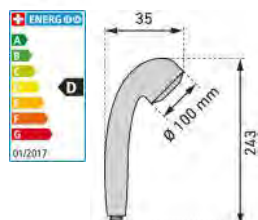

Erfüllt
Trinkwasseranforderungen
Conforme aux exigences en
matière d'eau potable

Swissline Brausen





Poignées de douches Swissline

| EAN-Nr. no EAN | Artikel Nr. no d'article | Beschreibung description | VPE ce | VE ue | UVP pro Stk. PVC CHF excl. | UVP pro Stk. PVC CHF incl. |
|-------------------|-----------------------------|-----------------------------|-----------|----------|----------------------------------|----------------------------------|
|-------------------|-----------------------------|-----------------------------|-----------|----------|----------------------------------|----------------------------------|

Duschbrause FIT-E eco

Poignée de douche FIT-E eco



| | | | | | | |
|---|-------------------|---|---|---|--------------|--------------|
|  7 612158 532338 | 09 2118 97 | verchromt chromé 1/2" / 1 Strahl/Jet ; EK: A / ~ 6 l/min | 1 |  | 56.85 | 61.23 |
|  7 611038 570330 | 09 2118 98 | verchromt chromé 1/2" / 1 Strahl/Jet ; EK: A | 3 |  | 57.78 | 62.23 |

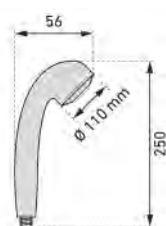





Erfüllt
Trinkwasseranforderungen
Conforme aux exigences en
matière d'eau potable

Duschbrause FIT-E trio

Poignée de douche FIT-E trio



| | | | | | | |
|---|-------------------|---|---|---|--------------|--------------|
|  7 612158 532345 | 09 2119 97 | verchromt chromé 1/2" / 3 Strahl/Jets ; EK: C | 1 |  | 67.10 | 72.27 |
|  7 611038 570347 | 09 2119 98 | verchromt chromé 1/2" / 3 Strahl/Jets ; EK: C | 3 |  | 68.03 | 73.27 |

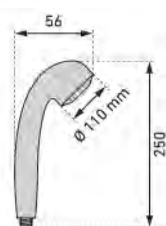

Erfüllt
Trinkwasseranforderungen
Conforme aux exigences en
matière d'eau potable





Swissline Brausen

Poignées de douches Swissline

| EAN-Nr. no EAN | Artikel Nr. no d'article | Beschreibung description | VPE ce | VE ue | UVP pro Stk. PVC CHF excl. | UVP pro Stk. PVC CHF incl. |
|-------------------|-----------------------------|-----------------------------|-----------|----------|----------------------------------|----------------------------------|
|-------------------|-----------------------------|-----------------------------|-----------|----------|----------------------------------|----------------------------------|

Duschbrause FIT-X slim

Poignée de douche FIT-X slim

| | | | | | | | |
|---|---|-------------------|--|---|---|--------------|--------------|
|  |  | 09 2115 97 | verchromt chromé 1/2" / 1 Strahl/Jet ; EK: B | 1 |  | 68.96 | 74.27 |
| |  | 09 2115 98 | verchromt chromé 1/2" / 1 Strahl/Jet ; EK: B / ~ 8 l/min | 3 |  | 69.90 | 75.28 |

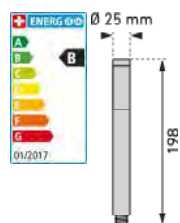



KWC
Swiss Water Experience

Erfüllt
Trinkwasseranforderungen
Conforme aux exigences en
matière d'eau potable

Duschbrause Fit

Poignée de douche Fit

| | | | | | | | |
|---|---|-------------------|--|---|---|--------------|--------------|
|  |  | 09 2050 96 | verchromt chromé 1/2" / 1 Strahl/Jet | 1 |  | 24.70 | 26.60 |
|---|---|-------------------|--|---|---|--------------|--------------|

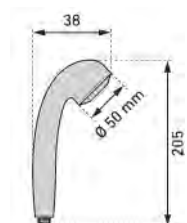

KWC
Swiss Water Experience





Swissline Brausen

Poignées de douches Swissline

| EAN-Nr. no EAN | Artikel Nr. no d'article | Beschreibung description | VPE ce | VE ue | UVP pro Stk. PVC CHF excl. | UVP pro Stk. PVC CHF incl. |
|-------------------|-----------------------------|-----------------------------|-----------|----------|----------------------------------|----------------------------------|
|-------------------|-----------------------------|-----------------------------|-----------|----------|----------------------------------|----------------------------------|

Duschbrause Twinstick

Poignée de douche Twinstick

| | | | | | | | |
|---|---|-------------------|--|---|---|--------------|--------------|
|  |  | 09 2114 96 | verchromt chromé ½" ; 1 Strahl/Jet | 1 |  | 80.15 | 86.32 |
| |  | 09 2114 98 | verchromt chromé ½" / 1 Strahl/Jet ; EK: B | 3 |  | 81.08 | 87.32 |

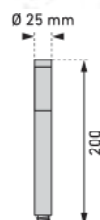



LAUFEN

Erfüllt
Trinkwasseranforderungen
Conforme aux exigences en
matière d'eau potable

Duschbrause Simijet Clean

Poignée douche Simijet Clean

| | | | | | | | |
|--|--|-------------------|--|---|--|--------------|--------------|
|  |  | 09 2030 96 | verchromt chromé ½" / 1 Strahl/Jet | 1 |  | 35.41 | 38.14 |
|--|--|-------------------|--|---|--|--------------|--------------|

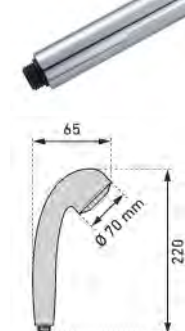

LAUFEN

Sieb demontierbar und einfach
zum reinigen.
Tamis démontable et facile à
nettoyer.

Swissline Brausen

Poignées de douches Swissline

| EAN-Nr. no EAN | Artikel Nr. no d'article | Beschreibung description | VPE ce | VE ue | UVP pro Stk. PVC CHF excl. | UVP pro Stk. PVC CHF incl. |
|-------------------|-----------------------------|-----------------------------|-----------|----------|----------------------------------|----------------------------------|
|-------------------|-----------------------------|-----------------------------|-----------|----------|----------------------------------|----------------------------------|

Brausegriff Simijet Multi

Poignée douche Simijet Multi



09 2112 96

verchromt
chromé
1/2" / 3 Strahl/Jets

1



49.39

53.20



LAUFEN

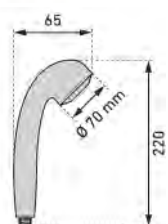

Brausegriff Milor Aquajet

Poignée douche Milor Aquajet



09 2113 97

verchromt
chromé
1/2" / 1 Strahl/Jet

1



34.48

37.14



LAUFEN

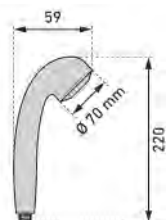

Sieb demontierbar und einfach zum reinigen.

Tamis démontable et facile à nettoyer.





Laufen Duschbrausen

Poignées de douches Laufen

| EAN-Nr. no EAN | Artikel Nr. no d'article | Beschreibung description | VPE ce | VE ue | UVP pro Stk. PVC CHF excl. | UVP pro Stk. PVC CHF incl. |
|-------------------|-----------------------------|-----------------------------|-----------|----------|----------------------------------|----------------------------------|
|-------------------|-----------------------------|-----------------------------|-----------|----------|----------------------------------|----------------------------------|

Duschbrause MyTwin100

Poignée de douche MyTwin100

| | | | | | | | |
|---|--|-------------------|---|---|---|--------------|--------------|
|  |  7 612738 998646 | 06 8106 97 | verchromt chromé 1/2" / 1 Strahl/Jet ; EK: A / ~ 5.7 l/min | 1 |  | 55.92 | 60.22 |
| |  7 612738 998653 | 06 8102 97 | verchromt/weiss chromé-blanc 1/2" / 1 Strahl/Jet ; EK: A / ~ 5.7 l/min | 1 |  | | |



LAUFEN

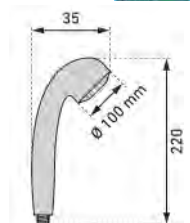

Erfüllt
Trinkwasseranforderungen
Conforme aux exigences en
matière d'eau potable

Laufen Duschbrausen

Poignées de douches Laufen





| EAN-Nr. no EAN | Artikel Nr. no d'article | Beschreibung description | VPE ce | VE ue | UVP pro Stk. PVC CHF excl. | UVP pro Stk. PVC CHF incl. |
|-------------------|-----------------------------|-----------------------------|-----------|----------|----------------------------------|----------------------------------|
|-------------------|-----------------------------|-----------------------------|-----------|----------|----------------------------------|----------------------------------|

| Duschbrause MyTwin120 | | Poignée de douche MyTwin120 | | | | | |
|--|--|-----------------------------|--|---|---|--------------|--------------|
|    |  7 612738 998677 | 06 8110 97 | verchromt <i>chromé</i> 1/2" / 3 Strahl/Jets ; EK: A / ~ 5.7 l/min | 1 |  | 79.22 | 85.32 |
| |  7 612742 505748 | 06 8111 97 | verchromt/schwarz <i>chromé-noir</i> 1/2" / 3 Strahl/Jets ; EK: A / ~ 5.7 l/min | 1 |  | 79.22 | 85.32 |
| |  7 612742 505786 | 06 8112 97 | verchromt/weiss <i>chromé-blanc</i> 1/2" / 3 Strahl/Jets ; EK: A / ~ 5.7 l/min | 1 |  | 79.22 | 85.32 |

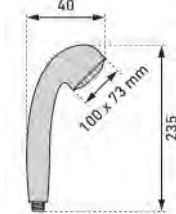

LAUFEN

Erfüllt
Trinkwasseranforderungen
*Conforme aux exigences en
matière d'eau potable*

| Duschbrause MyCity100 | | Poignée de douche MyCity100 | | | | | |
|---|--|-----------------------------|--|---|---|--------------|--------------|
|    |  7 612738 998707 | 06 8126 97 | verchromt <i>chromé</i> 1/2" / 1 Strahl/Jet ; EK: A / ~ 5.7 l/min | 1 |  | 55.92 | 60.22 |



LAUFEN

Erfüllt
Trinkwasseranforderungen
*Conforme aux exigences en
matière d'eau potable*

Laufen Duschbrausen

Poignées de douches Laufen

| EAN-Nr. no EAN | Artikel Nr. no d'article | Beschreibung description | VPE ce | VE ue | UVP pro Stk. PVC CHF excl. | UVP pro Stk. PVC CHF incl. |
|-------------------|-----------------------------|-----------------------------|-----------|----------|----------------------------------|----------------------------------|
|-------------------|-----------------------------|-----------------------------|-----------|----------|----------------------------------|----------------------------------|

| Duschbrause MyCity120 | | Poignée de douche MyCity120 | | | | | |
|---|--|-----------------------------|--|---|---|--------------|--------------|
|  |  7 612738 002084 | 06 8130 97 | verchromt <i>chromé</i> 1/2" / 3 Strahl/Jets ; EK: A / ~ 5.7 l/min | 1 |  | 79.22 | 85.32 |
| |  7 612742 505861 | 06 8131 97 | verchromt/schwarz <i>chromé-noir</i> 1/2" / 3 Strahl/Jets ; EK: A / ~ 5.7 l/min | 1 |  | 79.22 | 85.32 |
| |  7 612742 505762 | 06 8132 97 | verchromt/weiss <i>chromé-blanc</i> 1/2" / 3 Strahl/Jets ; EK: A / ~ 5.7 l/min | 1 |  | 79.22 | 85.32 |





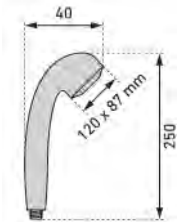

LAUFEN



Erfüllt
Trinkwasseranforderungen
Conforme aux exigences en
matière d'eau potable

NEW

| Duschbrause Stella 80 | | Poignée de douche Stella 80 | | | | | |
|---|--|-----------------------------|--|---|---|--------------|--------------|
|  |  7 612738 021931 | 09 2122 97 | verchromt <i>chromé</i> 1/2" / 1 Strahl/Jet | 1 |  | 38.68 | 41.65 |
| |  7 612738 021948 | 09 2123 97 | schwarz matt <i>noir mat</i> 1/2" / 1 Strahl/Jet | 1 |  | 57.78 | 62.23 |



LAUFEN

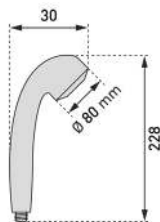

Erfüllt
Trinkwasseranforderungen
Conforme aux exigences en
matière d'eau potable

Laufen Duschbrausen

Poignées de douches Laufen

| EAN-Nr. no EAN | Artikel Nr. no d'article | Beschreibung description | VPE ce | VE ue | UVP pro Stk. PVC CHF excl. | UVP pro Stk. PVC CHF incl. |
|-------------------|-----------------------------|-----------------------------|-----------|----------|----------------------------------|----------------------------------|
|-------------------|-----------------------------|-----------------------------|-----------|----------|----------------------------------|----------------------------------|

NEW

Duschbrause Stella 80

Poignée de douche Stella 80



09 2124 97

verchromt
chromé
1/2" / 3 Strahl/Jet

1



48.46

52.19



09 2125 97

schwarz matt
noir mat
1/2" / 3 Strahl/Jet

1



68.03

73.27



09 2126 97

roségold
or rose
1/2" / 3 Strahl/Jet

1



68.03

73.27



LAUFEN

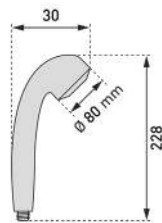

Erfüllt
Trinkwasseranforderungen
Conforme aux exigences en
matière d'eau potable

NEW

Duschbrause Stella 100

Poignée de douche Stella 100



09 2127 97

verchromt
chromé
1/2" / 3 Strahl/Jet

1



68.03

73.27



LAUFEN

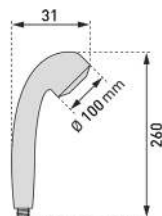

Erfüllt
Trinkwasseranforderungen
Conforme aux exigences en
matière d'eau potable

EcoBOOSTer Shower

| | | | | | | | |
|--|-------------------|-----------------------------|-----------------------------|-----------|----------|----------------------------------|----------------------------------|
| | EAN-Nr. no EAN | Artikel Nr. no d'article | Beschreibung description | VPE ce | VE ue | UVP pro Stk. PVC CHF excl. | UVP pro Stk. PVC CHF incl. |
|--|-------------------|-----------------------------|-----------------------------|-----------|----------|----------------------------------|----------------------------------|

NEW

Duschbrause Eco Uno

Poignée de douche Eco Uno

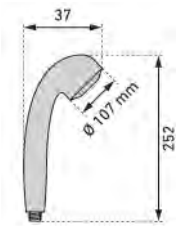

05 9848 98

verchromt
chromé
1/2" / 1 Strahl/Jet ; EK: B

3

1

37.23

40.10



Erfüllt
Trinkwasseranforderungen
Conforme aux exigences en
matière d'eau potable

Eco: ~8 l/min bei 3 bar
Boost: ~19 l/min bei 3 bar

NEW

Duschbrause Eco Tre

Poignée de douche Eco Tre

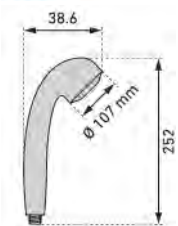

05 9849 98

verchromt
chromé
1/2" / 3 Strahl/Jets ; EK: B

3

1

41.89

45.12



Erfüllt
Trinkwasseranforderungen
Conforme aux exigences en
matière d'eau potable

Eco: ~8 l/min bei 3 bar
Boost: ~17 l/min bei 3 bar

LED Duschbrausen

Poignées de douches LED

| EAN-Nr. no EAN | Artikel Nr. no d'article | Beschreibung description | VPE ce | VE ue | UVP pro Stk. PVC CHF excl. | UVP pro Stk. PVC CHF incl. |
|-------------------|-----------------------------|-----------------------------|-----------|----------|----------------------------------|----------------------------------|
|-------------------|-----------------------------|-----------------------------|-----------|----------|----------------------------------|----------------------------------|

Duschbrause Lich LED Poignée de douche Lich LED



05 9819 98

verchromt
chromé
1/2" / 3 Strahl/Jets ; EK: C

3

1

36.81

39.65

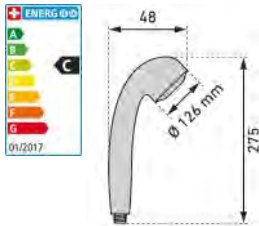
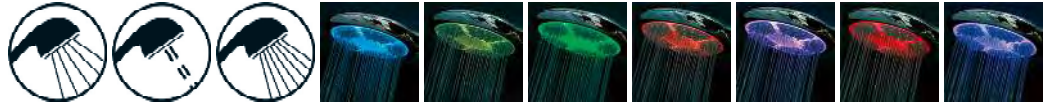

Erfüllt
Trinkwasseranforderungen
Conforme aux exigences en
matière d'eau potable

Duschbrause Keid LED Poignée de douche Keid LED



05 9813 98

verchromt
chromé
1/2" / 3 Strahl/Jets ; EK: C

3

1

48.46

52.19

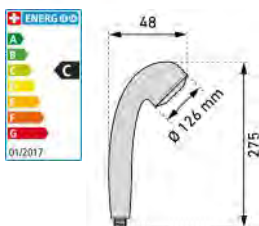

Temperaturanzeige auf LCD
Display.
Erfüllt
Trinkwasseranforderungen
Affichage de la température sur
écran LCD.
Conforme aux exigences en
matière d'eau potable

SHOWER 1 Strahl/Jet

| EAN-Nr. no EAN | Artikel Nr. no d'article | Beschreibung description | VPE ce | VE ue | UVP pro Stk. PVC CHF excl. | UVP pro Stk. PVC CHF incl. |
|-------------------|-----------------------------|-----------------------------|-----------|----------|----------------------------------|----------------------------------|
|-------------------|-----------------------------|-----------------------------|-----------|----------|----------------------------------|----------------------------------|

Duschbrause Deimos One PCR

Poignée douche Deimos One PCR



05 9811 98

verchromt
chromé
1/2" / 1 Strahl/Jet ; EK: B / ~ 7
l/min

3



10.62

11.44

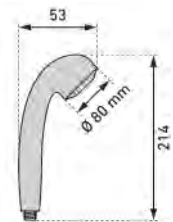

Erfüllt
Trinkwasseranforderungen
Conforme aux exigences en
matière d'eau potable

Duschbrause Ate PCR

Poignée de douche Ate PCR



05 9828 98

verchromt
chromé
1/2" / 1 Strahl/Jet ; EK: A / ~ 5
l/min

3



11.65

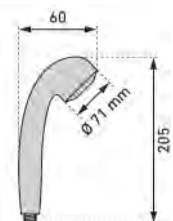

12.55



Erfüllt
Trinkwasseranforderungen
Conforme aux exigences en
matière d'eau potable



SHOWER 1 Strahl/Jet

| EAN-Nr. <i>no EAN</i> | Artikel Nr. <i>no d'article</i> | Beschreibung <i>description</i> | VPE <i>ce</i> | VE <i>ue</i> | UVP pro Stk. <i>PVC</i> CHF excl. | UVP pro Stk. <i>PVC</i> CHF incl. |
|--------------------------|------------------------------------|------------------------------------|------------------|-----------------|---|---|
|--------------------------|------------------------------------|------------------------------------|------------------|-----------------|---|---|

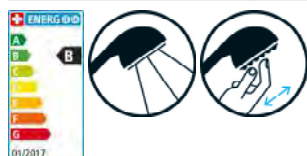
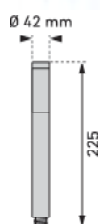
| Duschbrause Fenrir PCR | | Poignée de douche Fenrir | | | | | |
|---|--|--------------------------|--|---|---|-------|-------|
|  |  7 611038 569938 | 05 9834 98 | verchromt <i>chromé</i> 1/2" / 1 Strahl/Jet ; EK: B / ~ 7 l/min | 3 |  | 12.58 | 13.55 |



Erfüllt
Trinkwasseranforderungen
*Conforme aux exigences en
matière d'eau potable*

| Duschbrause Gerda | | Poignée de douche Gerda | | | | | |
|---|--|-------------------------|---|---|---|-------|-------|
|  |  7 611038 570095 | 05 9816 98 | verchromt <i>chromé</i> 1/2" / 1 Strahl/Jet ; EK: B | 3 |  | 12.58 | 13.55 |

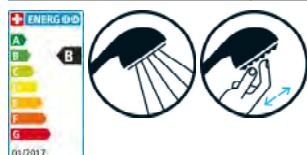
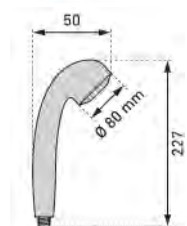

Erfüllt
Trinkwasseranforderungen
*Conforme aux exigences en
matière d'eau potable*

SHOWER 1 Strahl/Jet

| EAN-Nr. no EAN | Artikel Nr. no d'article | Beschreibung description | VPE ce | VE ue | UVP pro Stk. PVC CHF excl. | UVP pro Stk. PVC CHF incl. |
|-------------------|-----------------------------|-----------------------------|-----------|----------|----------------------------------|----------------------------------|
|-------------------|-----------------------------|-----------------------------|-----------|----------|----------------------------------|----------------------------------|

Duschbrause Topas PCR

Poignée de douche Topas PCR



05 9866 98

topas
topaze
1/2" / 1 Strahl/Jet ; EK: C / 10
l/min

3



12.86

13.85

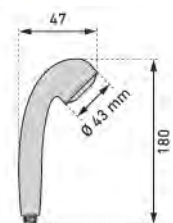

O-Ring zu Brausegriff Topas

Jointts torique p.douche topaze



78 2040 94

NBR
70° SHORE ; 29.00 x 2.00 mm

1



3.31

3.56

Duschbrause Puck PCR

Poignée de douche Puck PCR



05 9837 98

verchromt
chromé
1/2" / 1 Strahl/Jet ; EK: A / ~ 5
l/min

3



13.51

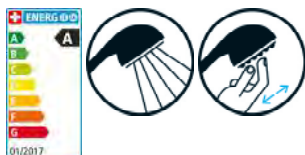
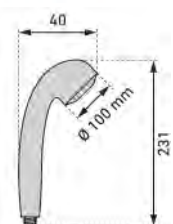

14.55



Erfüllt
Trinkwasseranforderungen
Conforme aux exigences en
matière d'eau potable



SHOWER 1 Strahl/Jet

| EAN-Nr. no EAN | Artikel Nr. no d'article | Beschreibung description | VPE ce | VE ue | UVP pro Stk. PVC CHF excl. | UVP pro Stk. PVC CHF incl. |
|-------------------|-----------------------------|-----------------------------|-----------|----------|----------------------------------|----------------------------------|
|-------------------|-----------------------------|-----------------------------|-----------|----------|----------------------------------|----------------------------------|

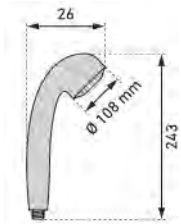
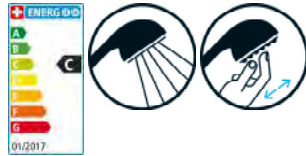
| Duschbrause Styx PCR | | Poignée de douche Styx PCR | | | | | |
|---|--|----------------------------|--|---|--|-------|-------|
|  |  7 611038 569990 | 05 9840 98 | verchromt chromé 1/2" / 1 Strahl/Jet ; EK: C / ~ 10 l/min | 3 |  1 | 13.51 | 14.55 |



Erfüllt
Trinkwasseranforderungen
Conforme aux exigences en
matière d'eau potable

| Duschbrause Aitne PCR | | Poignée douche Aitne PCR | | | | | |
|---|--|--------------------------|--|---|--|-------|-------|
|  |  7 611038 570163 | 05 9809 98 | verchromt chromé 1/2" / 1 Strahl/Jet ; EK: C / ~ 10 l/min | 3 |  1 | 14.54 | 15.66 |

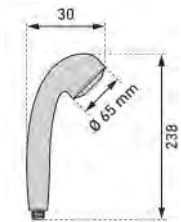









Erfüllt
Trinkwasseranforderungen
Conforme aux exigences en
matière d'eau potable

SHOWER 1 Strahl/Jet

| EAN-Nr. <i>no EAN</i> | Artikel Nr. <i>no d'article</i> | Beschreibung <i>description</i> | VPE <i>ce</i> | VE <i>ue</i> | UVP pro Stk. <i>PVC</i> CHF excl. | UVP pro Stk. <i>PVC</i> CHF incl. |
|--------------------------|------------------------------------|------------------------------------|------------------|-----------------|---|---|
|--------------------------|------------------------------------|------------------------------------|------------------|-----------------|---|---|

Duschbrause Sabik One PCR

Poignée douche Sabik One PCR

| | | | | | | | |
|--|--|-------------------|--|---|--|--------------|--------------|
|  |  7 611038 570156 | 05 9844 98 | verchromt <i>chromé</i> 1/2" / 1 Strahl/Jet ; EK: B | 3 |  1 | 14.54 | 15.66 |
|  |  7 611038 569907 | 05 9845 98 | schwarz matt <i>noir mat</i> 1/2" / 1 Strahl/Jet ; EK: B | 3 |  1 | 17.43 | 18.77 |
|  |  7 611038 426088 | 05 9808 98 | weiss <i>blanc</i> 1/2" / 1 Strahl/Jet ; EK: B | 3 |  1 | 14.54 | 15.66 |

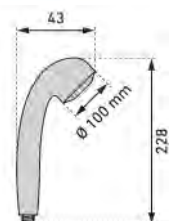



Erfüllt
Trinkwasseranforderungen
*Conforme aux exigences en
matière d'eau potable*

SHOWER 1 Strahl/Jet

| EAN-Nr. no EAN | Artikel Nr. no d'article | Beschreibung description | VPE ce | VE ue | UVP pro Stk. PVC CHF excl. | UVP pro Stk. PVC CHF incl. |
|-------------------|-----------------------------|-----------------------------|-----------|----------|----------------------------------|----------------------------------|
|-------------------|-----------------------------|-----------------------------|-----------|----------|----------------------------------|----------------------------------|

Duschbrause Wei PCR

Poignée douche Wei PCR

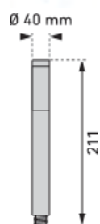

| | | | | | | | |
|---|--|-------------------|---|---|---|--------------|--------------|
|  |  7 611038 570149 | 05 9810 98 | verchromt chromé 1/2" / 1 Strahl/Jet ; EK: B / ~ 7 l/min | 3 |  | 16.50 | 17.77 |
|---|--|-------------------|---|---|---|--------------|--------------|



Erfüllt
Trinkwasseranforderungen
Conforme aux exigences en
matière d'eau potable

Duschbrause Monoton PCR

Poignée de douche Monoton PCR

| | | | | | | | |
|---|--|-------------------|--|---|---|--------------|--------------|
|  |  7 611038 179731 | 05 9930 98 | verchromt chromé 1/2" / 1 Strahl/Jet ; EK: C / ~ 10 l/min | 3 |  | 16.87 | 18.17 |
|---|--|-------------------|--|---|---|--------------|--------------|

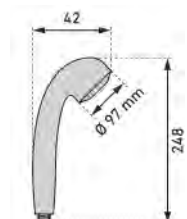

Erfüllt
Trinkwasseranforderungen
Conforme aux exigences en
matière d'eau potable

SHOWER 1 Strahl/Jet

| EAN-Nr. no EAN | Artikel Nr. no d'article | Beschreibung description | VPE ce | VE ue | UVP pro Stk. PVC CHF excl. | UVP pro Stk. PVC CHF incl. |
|-------------------|-----------------------------|-----------------------------|-----------|----------|----------------------------------|----------------------------------|
|-------------------|-----------------------------|-----------------------------|-----------|----------|----------------------------------|----------------------------------|

Duschbrause Hole PCR

Poignée de douche Hole PCR



05 9826 98

verchromt
chromé
1/2" / 1 Strahl/Jet ; EK: C / ~ 10
l/min

3



17.43

18.77

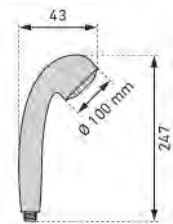

Erfüllt
Trinkwasseranforderungen
Conforme aux exigences en
matière d'eau potable

Duschbrause Vala One PCR

Poignée de douche Vala One PCR



05 9814 98

verchromt
chromé
1/2" / 1 Strahl/Jet ; EK: C / ~ 10
l/min

3



19.57

21.08

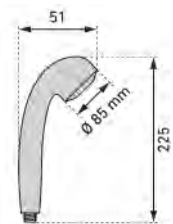
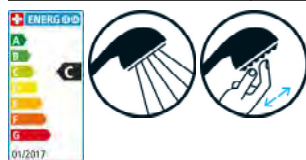



Erfüllt
Trinkwasseranforderungen
Conforme aux exigences en
matière d'eau potable

SHOWER 1 Strahl/Jet

| EAN-Nr. no EAN | Artikel Nr. no d'article | Beschreibung description | VPE ce | VE ue | UVP pro Stk. PVC CHF excl. | UVP pro Stk. PVC CHF incl. |
|-------------------|-----------------------------|-----------------------------|-----------|----------|----------------------------------|----------------------------------|
|-------------------|-----------------------------|-----------------------------|-----------|----------|----------------------------------|----------------------------------|

Duschbrause Skoll PCR

Poignée de douche Skoll PCR

| | | | | | | | |
|---|--|-------------------|---|---|---|--------------|--------------|
|  |  7 611038 569945 | 05 9835 98 | verchromt chromé 1/2" / 1 Strahl/Jet ; EK: C / ~ 10 l/min | 3 |  | 22.37 | 24.09 |
|---|--|-------------------|---|---|---|--------------|--------------|



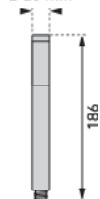

Ø 23 mm



Erfüllt
Trinkwasseranforderungen
Conforme aux exigences en
matière d'eau potable

Brausegriff mit Hilfsgriff

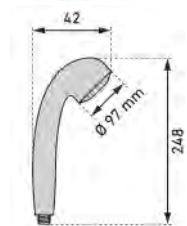

Poignée de douche avec manche

| | | | | | | | |
|---|--|-------------------|--|---|---|--------------|--------------|
|  |  7 611038 118334 | 06 1972 96 | verchromt/grau chromé/gris 1/2" / 1 Strahl/Jet | 5 |  | 41.01 | 44.16 |
|---|--|-------------------|--|---|---|--------------|--------------|



Hilfsgriff für Brausegriffe

Manche pour poignée de douche

| | | | | | | | |
|---|--|-------------------|-----------------------------|---|---|--------------|-------------|
|  |  7 611038 186852 | 06 1970 96 | grau gris 35 x 200 mm | 1 |  | 19.50 | 21.— |
|---|--|-------------------|-----------------------------|---|---|--------------|-------------|



SHOWER 3 Strahl/Jets

| EAN-Nr. no EAN | Artikel Nr. no d'article | Beschreibung description | VPE ce | VE ue | UVP pro Stk. PVC CHF excl. | UVP pro Stk. PVC CHF incl. |
|-------------------|-----------------------------|-----------------------------|-----------|----------|----------------------------------|----------------------------------|
|-------------------|-----------------------------|-----------------------------|-----------|----------|----------------------------------|----------------------------------|

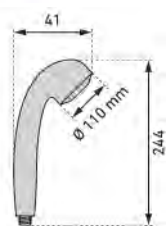
| Duschbrause Ariel | | Poignée douche Ariel | | | | | |
|---|--|----------------------|---|---|--|-------|-------|
|  |  7 611038 569952 | 05 9836 98 | verchromt chromé 1/2" / 3 Strahl/Jets ; EK: C | 3 |  1 | 19.57 | 21.08 |



Erfüllt
Trinkwasseranforderungen
Conforme aux exigences en
matière d'eau potable

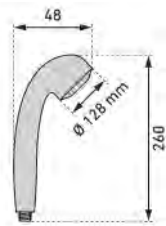

| Duschbrause Thisbe PCR | | Poignée douche Thisbe PCR | | | | | |
|---|--|---------------------------|--|---|--|-------|-------|
|  |  7 611038 570002 | 05 9841 98 | verchromt chromé 1/2" / 3 Strahl/Jets ; EK: B / ~ 7 l/min | 3 |  1 | 19.57 | 21.08 |



Erfüllt
Trinkwasseranforderungen
Conforme aux exigences en
matière d'eau potable



SHOWER 3 Strahl/Jets

| EAN-Nr. no EAN | Artikel Nr. no d'article | Beschreibung description | VPE ce | VE ue | UVP pro Stk. PVC CHF excl. | UVP pro Stk. PVC CHF incl. |
|-------------------|-----------------------------|-----------------------------|-----------|----------|----------------------------------|----------------------------------|
|-------------------|-----------------------------|-----------------------------|-----------|----------|----------------------------------|----------------------------------|

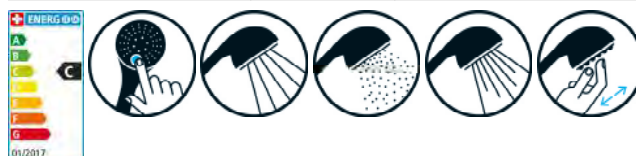
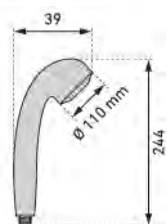
| Duschbrause Klytia PCR | | Poignée douche Klytia PCR | | | | | |
|---|--|---------------------------|---|---|---|-------|-------|
|  |  7 611038 570019 | 05 9842 98 | verchromt chromé 1/2" / 3 Strahl/Jets ; EK: C / ~ 10 l/min | 3 |  | 19.57 | 21.08 |



Erfüllt
Trinkwasseranforderungen
Conforme aux exigences en
matière d'eau potable

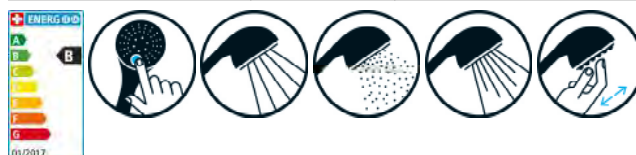
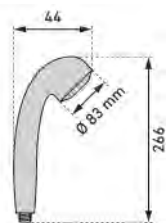

| Duschbrause Prospero PCR | | Poignée douche Prospero PCR | | | | | |
|---|--|-----------------------------|--|---|---|-------|-------|
|  |  7 611038 570026 | 05 9843 98 | verchromt chromé 1/2" / 3 Strahl/Jets ; EK: B / ~ 7 l/min | 3 |  | 19.57 | 21.08 |



Erfüllt
Trinkwasseranforderungen
Conforme aux exigences en
matière d'eau potable



SHOWER 3 Strahl/Jets

| EAN-Nr. no EAN | Artikel Nr. no d'article | Beschreibung description | VPE ce | VE ue | UVP pro Stk. PVC CHF excl. | UVP pro Stk. PVC CHF incl. |
|-------------------|-----------------------------|-----------------------------|-----------|----------|----------------------------------|----------------------------------|
|-------------------|-----------------------------|-----------------------------|-----------|----------|----------------------------------|----------------------------------|

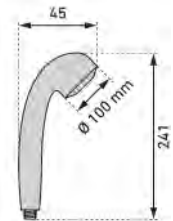
| Duschbrause Sabik Tre PCR | | Poignée douche Sabik Tre PCR | | | | | |
|---|--|------------------------------|--|---|--|-------|-------|
|  |  7 611038 570088 | 05 9818 98 | verchromt chromé 1/2" / 3 Strahl/Jets ; EK: A / ~ 5 l/min | 3 |  1 | 19.57 | 21.08 |



Erfüllt
Trinkwasseranforderungen
Conforme aux exigences en
matière d'eau potable

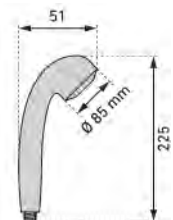

| Duschbrause Vala Tre PCR | | Poignée de douche Vala Tre PCR | | | | | |
|---|--|--------------------------------|---|---|--|-------|-------|
|  |  7 611038 570118 | 05 9815 98 | verchromt chromé 1/2" / 3 Strahl/Jets ; EK: C / ~ 10 l/min | 3 |  1 | 22.37 | 24.09 |



Erfüllt
Trinkwasseranforderungen
Conforme aux exigences en
matière d'eau potable



SHOWER 3 Strahl/Jets

| EAN-Nr. no EAN | Artikel Nr. no d'article | Beschreibung description | VPE ce | VE ue | UVP pro Stk. PVC CHF excl. | UVP pro Stk. PVC CHF incl. |
|-------------------|-----------------------------|-----------------------------|-----------|----------|----------------------------------|----------------------------------|
|-------------------|-----------------------------|-----------------------------|-----------|----------|----------------------------------|----------------------------------|

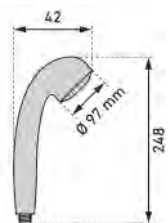
| Duschbrause Triton PCR | | Poignée de douche Triton PCR | | | | | |
|---|--|------------------------------|--|---|---|--------------|--------------|
|  |  7 611038 179755 | 05 9931 98 | verchromt <i>chromé</i> 1/2" / 3 Strahl/Jets ; EK: C / 10 l/min | 3 |  | 20.04 | 21.58 |



Erfüllt
Trinkwasseranforderungen
*Conforme aux exigences en
matière d'eau potable*

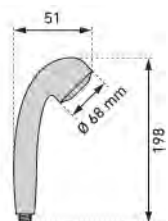

| Duschbrause Adhara PCR | | Poignée de douche Adhara PCR | | | | | |
|---|--|------------------------------|---|---|---|--------------|--------------|
|  |  7 611038 569983 | 05 9827 98 | verchromt <i>chromé</i> 1/2" / 3 Strahl/Jets ; EK: A / ~ 5 l/min | 3 |  | 15.47 | 16.66 |



Erfüllt
Trinkwasseranforderungen
*Conforme aux exigences en
matière d'eau potable*



SHOWER 3 Strahl/Jets

| EAN-Nr. no EAN | Artikel Nr. no d'article | Beschreibung description | VPE ce | VE ue | UVP pro Stk. PVC CHF excl. | UVP pro Stk. PVC CHF incl. |
|-------------------|-----------------------------|-----------------------------|-----------|----------|----------------------------------|----------------------------------|
|-------------------|-----------------------------|-----------------------------|-----------|----------|----------------------------------|----------------------------------|

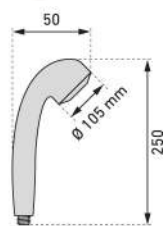
| Duschbrause Flow | | Poignée de douche Flow | | | | |
|---|--|------------------------|---|---|--|---------------------------|
|  |  7 611038 179410 | 05 9884 98 | verchromt chromé 1/2" / 3 Strahl/Jets ; EK: C | 3 |  1 | 26.56 28.61 |



Erfüllt
Trinkwasseranforderungen
Conforme aux exigences en
matière d'eau potable

| Duschbrause Hera PCR | | Poignée douche Hera PCR | | | | |
|---|--|-------------------------|---|---|--|---------------------------|
|  |  7 611038 570057 | 05 9846 98 | verchromt chromé 1/2" / 3 Strahl/Jets ; EK: C / - 10 l/min | 3 |  1 | 27.03 29.11 |

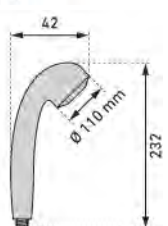



Erfüllt
Trinkwasseranforderungen
Conforme aux exigences en
matière d'eau potable

SHOWER 3 Strahl/Jets

| EAN-Nr. no EAN | Artikel Nr. no d'article | Beschreibung description | VPE ce | VE ue | UVP pro Stk. PVC CHF excl. | UVP pro Stk. PVC CHF incl. |
|-------------------|-----------------------------|-----------------------------|-----------|----------|----------------------------------|----------------------------------|
|-------------------|-----------------------------|-----------------------------|-----------|----------|----------------------------------|----------------------------------|

Duschbrause Siwa PCR

Poignée douche Siwa PCR

| | | | | | | | |
|---|--|-------------------|--|---|--|--------------|--------------|
|  |  7 611038 569921 | 05 9833 98 | verchromt chromé 1/2" / 3 Strahl/Jets ; EK: B / ~ 7 l/min | 3 |  1 | 34.02 | 36.64 |
|---|--|-------------------|--|---|--|--------------|--------------|

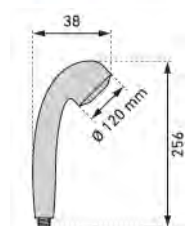

Erfüllt
Trinkwasseranforderungen
Conforme aux exigences en
matière d'eau potable

Duschbrause Dike PCR

Poignée douche Dike PCR

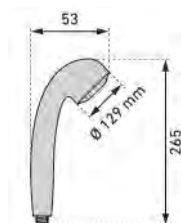

| | | | | | | | |
|---|--|-------------------|---|---|--|--------------|--------------|
|  |  7 611038 570040 | 05 9831 98 | verchromt chromé 1/2" / 3 Strahl/Jets ; EK: B / ~ 7 l/min | 3 |  1 | 34.02 | 36.64 |
|  |  7 611038 569914 | 05 9832 98 | schwarz matt noir mat 1/2" / 3 Strahl/Jets ; EK: B / ~ 7 l/min | 3 |  1 | 35.88 | 38.64 |
|  |  7 611038 387884 | 05 9806 98 | weiss matt blanc mat 1/2" / 3 Strahl/Jets ; EK: B / ~ 7 l/min | 3 |  1 | 34.48 | 37.14 |



Erfüllt
Trinkwasseranforderungen
Conforme aux exigences en
matière d'eau potable

SHOWER 3 Strahl/Jets

| | | | | | | | |
|--|--------------------------|------------------------------------|------------------------------------|------------------|-----------------|---|---|
| | EAN-Nr. <i>no EAN</i> | Artikel Nr. <i>no d'article</i> | Beschreibung <i>description</i> | VPE <i>ce</i> | VE <i>ue</i> | UVP pro Stk. <i>PVC</i> CHF excl. | UVP pro Stk. <i>PVC</i> CHF incl. |
|--|--------------------------|------------------------------------|------------------------------------|------------------|-----------------|---|---|

| Duschbrause Greip PCR | | Poignée douche Greip PCR | | | | | |
|---|--|--------------------------|--|---|--|--------------|--------------|
|  |  7 611038 569891 | 05 9830 98 | verchromt <i>chromé</i> 1/2" / 3 Strahl/Jets ; EK: C / ~ 10 l/min | 3 |  1 | 43.80 | 47.17 |

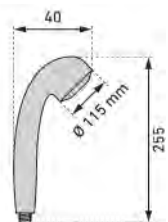

Erfüllt
 Trinkwasseranforderungen
*Conforme aux exigences en
 matière d'eau potable*

SHOWER 5 Strahl/Jets

| EAN-Nr. <i>no EAN</i> | Artikel Nr. <i>no d'article</i> | Beschreibung <i>description</i> | VPE <i>ce</i> | VE <i>ue</i> | UVP pro Stk. <i>PVC</i> CHF excl. | UVP pro Stk. <i>PVC</i> CHF incl. |
|--------------------------|------------------------------------|------------------------------------|------------------|-----------------|---|---|
|--------------------------|------------------------------------|------------------------------------|------------------|-----------------|---|---|

Duschbrause Deimos Cinco PCR

Poignée douche Deimos Cinc PCR



05 9812 98

verchromt
chromé
1/2" / 5 Strahl/Jets ; EK: A / ~ 5
l/min

3

1

20.50

22.08

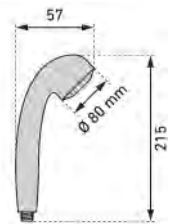

Erfüllt
Trinkwasseranforderungen
*Conforme aux exigences en
matière d'eau potable*

Duschbrause Telesto PCR

Poignée douche Telesto PCR



05 9829 98

verchromt
chromé
1/2" / 5 Strahl/Jets ; EK: C / ~
10 l/min

3

1

22.37

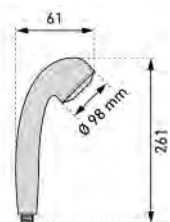

24.09



Erfüllt
Trinkwasseranforderungen
*Conforme aux exigences en
matière d'eau potable*



SHOWER 5 Strahl/Jets

| EAN-Nr. no EAN | Artikel Nr. no d'article | Beschreibung description | VPE ce | VE ue | UVP pro Stk. PVC CHF excl. | UVP pro Stk. PVC CHF incl. |
|-------------------|-----------------------------|-----------------------------|-----------|----------|----------------------------------|----------------------------------|
|-------------------|-----------------------------|-----------------------------|-----------|----------|----------------------------------|----------------------------------|

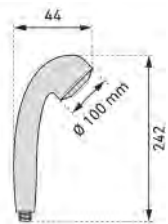
| Duschbrause Frigga PCR | | Poignée douche Frigga PCR | | | | | |
|---|--|---------------------------|--|---|--|--------------|--------------|
|  |  7 611038 570033 | 05 9839 98 | verchromt chromé 1/2" / 5 Strahl/Jets ; EK: B / ~ 7 l/min | 3 |  1 | 22.37 | 24.09 |



Erfüllt
Trinkwasseranforderungen
Conforme aux exigences en
matière d'eau potable

| Duschbrause Naos PCR | | Poignée de douche Naos PCR | | | | | |
|---|--|----------------------------|--|---|--|--------------|--------------|
|  |  7 611038 570064 | 05 9847 98 | verchromt chromé 1/2" / 5 Strahl/Jets ; EK: B / ~ 7 l/min | 3 |  1 | 22.37 | 24.09 |

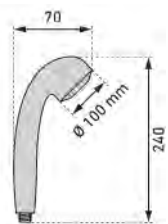



Erfüllt
Trinkwasseranforderungen
Conforme aux exigences en
matière d'eau potable

SHOWER 5 Strahl/Jets

| EAN-Nr. <i>no EAN</i> | Artikel Nr. <i>no d'article</i> | Beschreibung <i>description</i> | VPE <i>ce</i> | VE <i>ue</i> | UVP pro Stk. <i>PVC</i> CHF excl. | UVP pro Stk. <i>PVC</i> CHF incl. |
|--------------------------|------------------------------------|------------------------------------|------------------|-----------------|---|---|
|--------------------------|------------------------------------|------------------------------------|------------------|-----------------|---|---|

| Duschbrause Caliban PCR | Poignée douche Caliban PCR | | | | | |
|-------------------------|----------------------------|--|--|--|--|--|
|-------------------------|----------------------------|--|--|--|--|--|

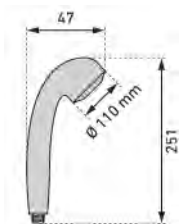

| | | | | | | | |
|---|--|-------------------|--|---|---|--------------|--------------|
|  |  7 611038 569976 | 05 9838 98 | verchromt <i>chromé</i> 1/2" / 5 Strahl/Jets ; EK: C / ~ 10 l/min | 3 |  | 24.23 | 26.10 |
| | | | | | | | |



Erfüllt
 Trinkwasseranforderungen
*Conforme aux exigences en
 matière d'eau potable*

SHOWER 8 Strahl/Jets

| | | | | | | |
|--------------------------|------------------------------------|------------------------------------|------------------|-----------------|---|---|
| EAN-Nr. <i>no EAN</i> | Artikel Nr. <i>no d'article</i> | Beschreibung <i>description</i> | VPE <i>ce</i> | VE <i>ue</i> | UVP pro Stk. <i>PVC</i> CHF excl. | UVP pro Stk. <i>PVC</i> CHF incl. |
|--------------------------|------------------------------------|------------------------------------|------------------|-----------------|---|---|

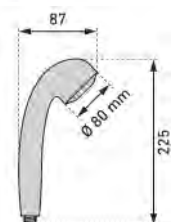

| | | | | | | |
|---|--|-------------------------------------|--|---|--|---------------------------|
| Duschbrause Sargas PCR | | Poignée de douche Sargas PCR | | | | |
|  |  7 611038 569846 | 05 9825 98 | verchromt <i>chromé</i> 1/2" / 8 Strahl/Jets ; EK: C / ~ 10 l/min | 3 |  1 | 27.03 29.11 |



Erfüllt
Trinkwasseranforderungen
*Conforme aux exigences en
matière d'eau potable*

SHOWER

| | | | | | | |
|-------------------|-----------------------------|-----------------------------|-----------|----------|----------------------------------|----------------------------------|
| EAN-Nr. no EAN | Artikel Nr. no d'article | Beschreibung description | VPE ce | VE ue | UVP pro Stk. PVC CHF excl. | UVP pro Stk. PVC CHF incl. |
|-------------------|-----------------------------|-----------------------------|-----------|----------|----------------------------------|----------------------------------|

| Kombidusche für Bad & Küche | | Douche combinat. bain & cuisine | | | | |
|---|--|---------------------------------|---|---|---|-------------|
|  |  7 611038 166748 | 05 9751 97 | verchromt/poliert chromé/polé 150 cm / M22/24 ; EK: C / 1 Strahl/Jet | 3 |  | 24.70 26.60 |



Beinhaltet Umstellbrause, Brausehalter, Umsteller und Brauseschlauch aus Metall 150cm verchromt.
Contient une douchette de substitution, le porte-douchette, l'inverseur à rotule et le flexible de douche en métal de 150cm.



Einfache und rasche Montage
Pose facile et rapide.

Passt an alle handelsüblichen Armaturen mit M22 und M24 Anschlussgewinde.
Est compatible avec toutes les robinetteries ayant un filetage de raccordement M22 et M24.

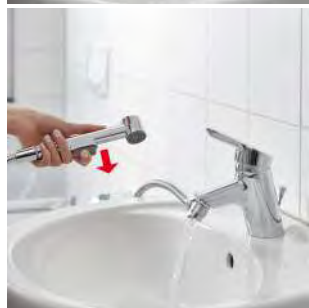
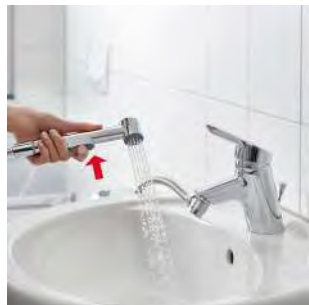











Mittels Knopfdruck am Brausegriff schaltet der Umsteller automatisch um.
Il suffit d'appuyer sur le bouton de la poignée de la douchette pour que l'inverseur du robinet change de position.

Erfüllt Trinkwasseranforderungen
Conforme aux exigences en matière d'eau potable





SHOWER

| EAN-Nr. no EAN | Artikel Nr. no d'article | Beschreibung description | VPE ce | VE ue | UVP pro Stk. PVC CHF excl. | UVP pro Stk. PVC CHF incl. |
|-------------------|-----------------------------|-----------------------------|-----------|----------|----------------------------------|----------------------------------|
|-------------------|-----------------------------|-----------------------------|-----------|----------|----------------------------------|----------------------------------|

| Brausegarnitur Topas PCR | | Garniture de douche Topas PCR | | | | | |
|---|--|-------------------------------|---|---|---|--------------|--------------|
|  |  7 611038 244132 | 05 9797 98 | topas/verchromt topaze/chromé 1/2" x 150 cm / 1 Strahl/Jet ; EK: B / ~ 7 l/min | 5 |  | 20.04 | 21.58 |
| |  7 611038 244156 | 05 9798 98 | topas/verchromt topaze/chromé 1/2" x 150 cm / 1 Strahl/Jet ; EK: E | 5 |  | 20.04 | 21.58 |
| |  7 611038 244149 | 05 9799 98 | topas/verchromt topaze/chromé 1/2" x 180 cm / 1 Strahl/Jet ; EK: E | 5 |  | 22.83 | 24.59 |
|  | | | | | | | |

| Brausegarnitur Ate | | Set de douche Ate | | | | | |
|---|---|-------------------|--|---|---|--------------|--------------|
|  |  7 611038 570224 | 05 9781 98 | verchromt chromé 1/2" / 1 Strahl/Jet ; EK: C / 180 cm | 3 |  | 21.43 | 23.09 |
| |  | | | | | | |

Erfüllt
Trinkwasseranforderungen
Conforme aux exigences en
matière d'eau potable

| Brausegarnitur Deimos One PCR | | Set de douche Deimos One PCR | | | | | |
|---|--|------------------------------|--|---|---|--------------|--------------|
|  |  7 611038 570248 | 05 9779 98 | verchromt chromé 1/2" x 180 cm / 1 Strahl/Jet ; EK: C | 3 |  | 24.23 | 26.10 |
| |  | | | | | | |

Erfüllt
Trinkwasseranforderungen
Conforme aux exigences en
matière d'eau potable

SHOWER

| EAN-Nr. no EAN | Artikel Nr. no d'article | Beschreibung description | VPE ce | VE ue | UVP pro Stk. PVC CHF excl. | UVP pro Stk. PVC CHF incl. |
|-------------------|-----------------------------|-----------------------------|-----------|----------|----------------------------------|----------------------------------|
|-------------------|-----------------------------|-----------------------------|-----------|----------|----------------------------------|----------------------------------|

| Brausegarn. Deimos Cinco PCR | | Set de douche Deimos Cinco PCR | | | | |
|------------------------------|--|--------------------------------|--|--|--|--|
|------------------------------|--|--------------------------------|--|--|--|--|



05 9780 98

verchromt
chromé
1/2" x 180 cm / 5 Strahl/Jets ;
EK: B

3



28.89

31.12



Erfüllt
Trinkwasseranforderungen
Conforme aux exigences en
matière d'eau potable

| Brauseset Hawaii | | Set de douche Hawaii | | | | |
|------------------|--|----------------------|--|--|--|--|
|------------------|--|----------------------|--|--|--|--|



05 9783 98

verchromt
chromé
1/2" / 1 Strahl/Jet ; EK: D / 150
cm

3



22.83

24.59



Erfüllt
Trinkwasseranforderungen
Conforme aux exigences en
matière d'eau potable

| Brauseset Menorca | | Set de douche Menorca | | | | |
|-------------------|--|-----------------------|--|--|--|--|
|-------------------|--|-----------------------|--|--|--|--|



05 9782 98

verchromt
chromé
1/2" / 3 Strahl/Jets ; EK: C / 150
cm

3



38.68

41.65





Erfüllt
Trinkwasseranforderungen
Conforme aux exigences en
matière d'eau potable

SHOWER

| EAN-Nr. <i>no EAN</i> | Artikel Nr. <i>no d'article</i> | Beschreibung <i>description</i> | VPE <i>ce</i> | VE <i>ue</i> | UVP pro Stk. <i>PVC</i> CHF excl. | UVP pro Stk. <i>PVC</i> CHF incl. |
|--------------------------|------------------------------------|------------------------------------|------------------|-----------------|---|---|
|--------------------------|------------------------------------|------------------------------------|------------------|-----------------|---|---|

Duschset Parsa 116

Set de douche Parsa 116

| | | | | | | |
|--|-------------------|--|---|---|--------------|--------------|
|  7 611038 172770 | 05 9749 97 | verchromt <i>chromé</i> 1/2" / 3 Strahl/Jets ; EK: C / Ø 18MM / 116CM | 3 |  | 49.39 | 53.20 |
|--|-------------------|--|---|---|--------------|--------------|









Erfüllt
Trinkwasseranforderungen
*Conforme aux exigences en
matière d'eau potable*

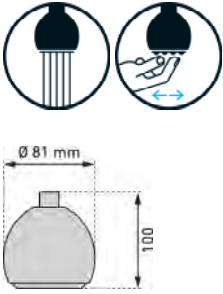

Kopfbrausen und Zubehör

Pommes de douche et accessoires

| EAN-Nr. no EAN | Artikel Nr. no d'article | Beschreibung description | VPE ce | VE ue | UVP pro Stk. PVC CHF excl. | UVP pro Stk. PVC CHF incl. |
|-------------------|-----------------------------|-----------------------------|-----------|----------|----------------------------------|----------------------------------|
|-------------------|-----------------------------|-----------------------------|-----------|----------|----------------------------------|----------------------------------|

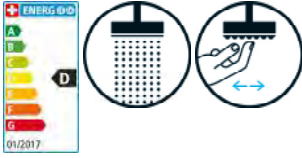
| Kopfbrause Max | | Pomme de douche Max | | | | | |
|---|--|---------------------|--|---|---|-------|-------|
|  <p>Kugelgelenk aus Messing Articulation à rotule en laiton DIN EN1112</p> |  7 611038 097745 | 02 6431 96 | verchromt chromé 1/2" / 1 Strahl/Jet | 1 |  | 46.60 | 50.19 |
| |  | | | | | | |



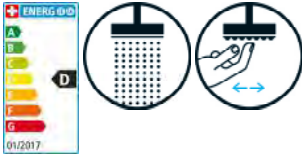









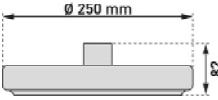

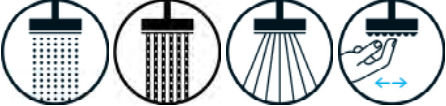



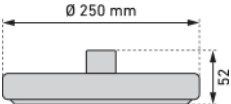
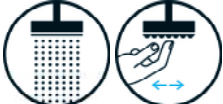

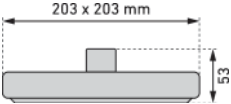
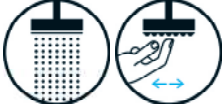

| Kopfbrause Runda | | Pomme de douche Runda | | | | | |
|--|--|-----------------------|--|---|---|-------|-------|
|  <p>Ø 250 mm 59</p> <p>Erfüllt Trinkwasseranforderungen Conforme aux exigences en matière d'eau potable</p> |  7 611038 570255 | 05 9419 97 | verchromt chromé 1/2" / 1 Strahl/Jet ; EK: D / Ø 250 mm | 1 |  | 38.68 | 41.65 |
| |  | | | | | | |

| Kopfbrause Ruud | | Pomme de douche Ruut | | | | | |
|--|--|----------------------|--|---|---|-------|-------|
|  <p>200 x 200 mm 60</p> <p>Erfüllt Trinkwasseranforderungen Conforme aux exigences en matière d'eau potable</p> |  7 611038 570262 | 05 9418 97 | verchromt chromé 1/2" / 1 Strahl/Jet ; EK: D / 200 x 200 mm | 1 |  | 38.68 | 41.65 |
| |  | | | | | | |

Kopfbrausen und Zubehör

Pommes de douche et accessoires

NEW

| | EAN-Nr. no EAN | Artikel Nr. no d'article | Beschreibung description | VPE ce | VE ue | UVP pro Stk. PVC CHF excl. | UVP pro Stk. PVC CHF incl. |
|---|---|---|---|-----------|---|----------------------------------|----------------------------------|
| Kopfbrause Tria Pomme de douche Tria | | | | | | | |
|  |  7 611038 700294 | 05 9424 97 | verchromt chromé 1/2" / 3 Strahl/Jet ; EK: B / Ø 250 mm | 3 |  | 68.03 | 73.27 |
|  |  |  | | | | | |
| Erfüllt Trinkwasseranforderungen Conforme aux exigences en matière d'eau potable | | | | | | | |
| Kopfbrause Albis Pomme de douche Albis | | | | | | | |
|  |  7 611038 097646 | 06 1937 97 | Messing verchromt laiton chromé 1/2" / 1 Strahl/Jet ; Ø 250 mm | 1 |  | 217.15 | 233.87 |
|  |  | | | | | | |
| Kopfbrause Brisen Pomme de douche Brisen | | | | | | | |
|  |  7 611038 097653 | 06 1938 97 | Messing verchromt laiton chromé 1/2" / 1 Strahl/Jet ; 203 x 203 mm | 1 |  | 241.38 | 259.96 |
|  |  | | | | | | |
| Anschlussbogen Coude murale | | | | | | | |
|  |  7 611038 072179 | 06 1928 97 | verchromt chromé 1/2" ; 300 mm | 1 |  | 151.91 | 163.61 |
| Anschlussbogen eckig Coude murale anguleux | | | | | | | |
|  |  7 611038 139971 | 05 9412 97 | verchromt chromé 1/2" ; 360 mm | 1 |  | 112.77 | 121.45 |
| Deckenanschluss eckig Tube pour plafond anguleux | | | | | | | |
|  |  7 611038 139964 | 05 9411 97 | verchromt chromé 1/2" ; 400 mm | 1 |  | 57.78 | 62.23 |



Brauseschläuche Flexibles de douche

Länge und Passform Longeur et coupe

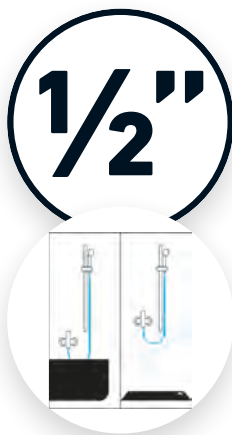

Die Schläuche sind in diversen Längen verfügbar und haben eine universelle Passform für alle handelsüblichen Armaturen und Duschbrausen.

Les flexibles de douche sont disponibles en diverses longueurs et s'adaptent universellement à tous les robinets et douches du commerce.

Verdrehsicherung Sécurité antitorcion



Drehbare Anschlüsse vermeiden, dass sich der Schlauch in der Dusche oder Badewanne verdreht.

Les raccords pivotants évitent que le tuyau ne se torde dans la douche ou la baignoire.

Reissfest Résistant à l'arrachement

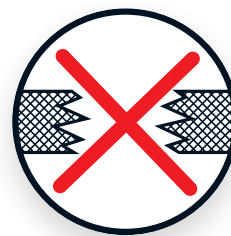

Die Schläuche sind doppelt gewunden und haben dadurch eine wesentliche höhere Lebensdauer als üblich.

Les flexibles de douche sont doublement enroulés, ce qui leur confère une durée de vie nettement plus longue que d'habitude.

Brauseschlauch CHROMALUX® Zero Flexible CHROMALUX® Zero

Einzigartige Oberfläche Surface unique

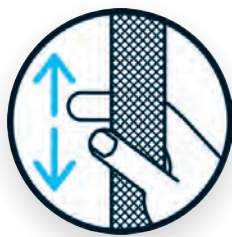

Die einzigartige Oberfläche des Schlauches ist wasserabweisend und einfach zu reinigen.

La surface unique du tuyau est hydrofuge et facile à nettoyer.

Ultraleicht und Hochflexibel Ultraléger et très flexible



Angenehme Handhabung des Schlauches aufgrund dessen Leichtigkeit und Flexibilität.

Manipulation agréable du tuyau en raison de sa légèreté et de sa flexibilité.

Reinigung in der Waschmaschine Nettoyage en machine à laver



In einem schützenden Waschbeutel kann der Schlauch in der Waschmaschine gewaschen werden.

Le tuyau peut être lavé en machine dans un sac de lavage protecteur.

Farben Couleurs

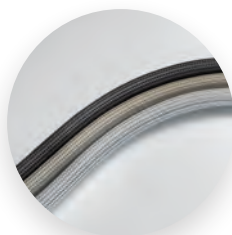

Erhältlich in den drei Farben schwarz, silver grey und silver steel.

Disponible en trois couleurs : noir, silver grey et silver steel.

Normen Normes

Erfüllt die folgenden Produktnormen, Zulassungen und Zertifikate:

Conforme aux normes de produits, approbations et certificats suivants:

- EN 1113
- ASME A112.18.1/CSA B125.1
- KTW
- W270
- ACS
- DVGW
- NF
- cUPC

Nachhaltigkeit Durabilité



Der CHROMALUX® Zero erfüllt Trinkwasseranforderungen und ist 100% PVC-frei sowie recyclebar.

Le CHROMALUX® Zero répond aux exigences en matière d'eau potable et est 100% exempt de PVC et recyclable.

CHROMALUX®

| EAN-Nr. no EAN | Artikel Nr. no d'article | Beschreibung description | VPE ce | VE ue | UVP pro Stk. PVC CHF excl. | UVP pro Stk. PVC CHF incl. |
|-------------------|-----------------------------|-----------------------------|-----------|----------|----------------------------------|----------------------------------|
|-------------------|-----------------------------|-----------------------------|-----------|----------|----------------------------------|----------------------------------|

Brauseschl. CHROMALUX® Zero

Flexible CHROMALUX® Zero



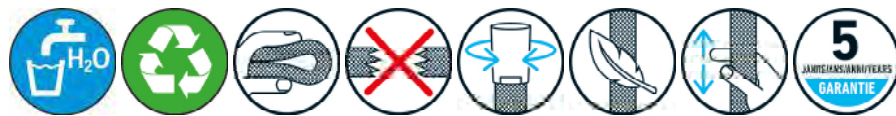

Einseitig mit Verdrehsicherung
Un côté avec douille tournante
EN1113

| | | | | | | |
|-----------------|-------------------|---|---|--|--------------|--------------|
| 4 005897 165579 | 05 7608 94 | silver grey / K x DK silver grey / D x DT 1/2" ; 80 cm | 1 | | 16.87 | 18.17 |
| 7 611038 834944 | 05 7610 96 | silver grey / K x DK silver grey / D x DT 1/2" ; 100 cm | 1 | | 17.43 | 18.77 |
| 7 611038 834951 | 05 7612 96 | silver grey / K x DK silver grey / D x DT 1/2" ; 125 cm | 1 | | 17.89 | 19.27 |
| 7 611038 250010 | 05 7615 98 | silver grey / K x DK silver grey / D x DT 1/2" ; 150 cm | 5 | | 16.96 | 18.27 |
| 7 611038 250027 | 05 7618 98 | silver grey / K x DK silver grey / D x DT 1/2" ; 180 cm | 5 | | 17.99 | 19.37 |
| 7 611038 250034 | 05 7620 98 | silver grey / K x DK silver grey / D x DT 1/2" ; 200 cm | 5 | | 19.11 | 20.58 |
| 7 611038 834968 | 05 7625 96 | silver grey / K x DK silver grey / D x DT 1/2" ; 250 cm | 1 | | 23.30 | 25.09 |
| 7 611038 834975 | 05 7630 96 | silver grey / K x DK silver grey / D x DT 1/2" ; 300 cm | 1 | | 27.49 | 29.61 |
| 7 611038 240042 | 05 7715 98 | silver steel / K x DK silver steel / D x DT 1/2" ; 150 cm | 5 | | 16.96 | 18.27 |
| 7 611038 250058 | 05 7718 98 | silver steel / K x DK silver steel / D x DT 1/2" ; 180 cm | 5 | | 17.99 | 19.37 |
| 7 611038 249991 | 05 7515 98 | schwarz / K x DK noir / D x DT 1/2" ; 150 cm | 5 | | 16.96 | 18.27 |
| 7 611038 250003 | 05 7518 98 | schwarz / K x DK noir / D x DT 1/2" ; 180 cm | 5 | | 17.99 | 19.37 |
| 7 611038 692407 | 05 7415 98 | schwarz / K x DK, schwarz noir / D x DT/ noir 1/2" ; 150 cm | 5 | | 16.96 | 18.27 |
| 7 611038 692414 | 05 7418 98 | schwarz / K x DK / schwarz noir / D x DT / noir 1/2" ; 180 cm | 5 | | 17.99 | 19.37 |



SHOWER

| EAN-Nr. no EAN | Artikel Nr. no d'article | Beschreibung description | VPE ce | VE ue | UVP pro Stk. PVC CHF excl. | UVP pro Stk. PVC CHF incl. |
|-------------------|-----------------------------|-----------------------------|-----------|----------|----------------------------------|----------------------------------|
|-------------------|-----------------------------|-----------------------------|-----------|----------|----------------------------------|----------------------------------|



| Kunststoffbrauseschlauch | | Flexible douche en plastique | | | | | |
|---|--|------------------------------|--|---|---|-------|-------|
|  |  7 611038 243463 | 05 3118 98 | chrom/6-kant x Kugeldrehkonus chromé/6-pans x DT à rotule 1/2" ; 180 cm | 5 |  | 40.54 | 43.66 |



Hochwertiger Kunststoffbrause-
schlauch mit Kugeldrehkonus
360° drehbar
30° schwenkbar
für höchste Beweglichkeit beim
Duschen, kein Verdrehen des
Brauseschlauchs

Erfüllt
Trinkwasseranforderungen
*Flexible en plastique haut de
gamme avec cône pivotant
rotation 360°
pivotement 30°
pour une flexibilité maximale
pendant la douche, pas de
torsion du flexible
Conforme aux exigences en
matière d'eau potable*



| Kunststoffbrauseschlauch Free | | Flexible en plastique Free | | | | | |
|---|--|----------------------------|---|---|---|-------|-------|
|  |  7 611038 174026 | 05 7218 98 | grau /6-kant x DK gris/6-pans x DT 1/2" ; 180CM | 5 |  | 33.55 | 36.13 |





PVC-freier Brauseschlauch aus
umweltfreundlichem Kunststoff,
hochwertig und hygienisch
unbedenklich. Einseitig mit
Verdrehsicherung.

Erfüllt
Trinkwasseranforderungen
*Flexible de douche sans PVC en
plastique écologique, de grande
qualité et irréprochable sur le plan
de l'hygiène. Un côté avec douille
tournante
Conforme aux exigences en
matière d'eau potable
EN1113*



SHOWER

| EAN-Nr. no EAN | Artikel Nr. no d'article | Beschreibung description | VPE ce | VE ue | UVP pro Stk. PVC CHF excl. | UVP pro Stk. PVC CHF incl. |
|-------------------|-----------------------------|-----------------------------|-----------|----------|----------------------------------|----------------------------------|
|-------------------|-----------------------------|-----------------------------|-----------|----------|----------------------------------|----------------------------------|

| Brauseschlauch Metallic | | Flexible de douche metallic | | | | | |
|---|--|-----------------------------|---|---|---|--------------|--------------|
|  |  7 611038 167707 | 05 8050 98 | silver - kunststoff / KK x DK silver-plastique/DC x DT 1/2" ; 180CM | 5 |  | 22.37 | 24.09 |











Einseitig mit Verdrehsicherung.
Erfüllt
Trinkwasseranforderungen
Un côté avec douille tournante
Conforme aux exigences en
matière d'eau potable

| Kunststoffbrauseschl. Classic | | Flexible en plastique Classic | | | | | |
|--|--|-------------------------------|---|---|---|--------------|--------------|
|  |  7 611038 099695 | 05 2818 98 | schwarz matt/K x DK noir mat/D x DT 1/2" ; 180 cm | 5 |  | 34.95 | 37.64 |



Einseitig mit Verdrehsicherung.
Erfüllt
Trinkwasseranforderungen
Un côté avec douille tournante
Conforme aux exigences en
matière d'eau potable





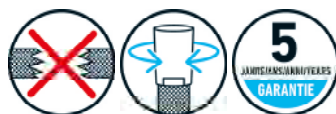

| Brauseschlauch Supreme | | Flexible de douche Supreme | | | | | |
|---|--|----------------------------|---|---|---|--------------|--------------|
|  |  7 611038 112035 | 06 3608 96 | silber/K x DK argent/D x DT 1/2" ; 80 cm | 1 |  | 25.63 | 27.60 |
| |  7 611038 112042 | 06 3615 96 | silber/K x DK argent/D x DT 1/2" ; 150 cm | 1 |  | 29.36 | 31.62 |
| |  7 611038 112059 | 06 3618 96 | silber/K x DK argent/D x DT 1/2" ; 180 cm | 1 |  | 30.29 | 32.62 |
| |  7 611038 112066 | 06 3620 96 | silber/K x DK argent/D x DT 1/2" ; 200 cm | 1 |  | 35.41 | 38.14 |

Einseitig mit Verdrehsicherung
Erfüllt
Trinkwasseranforderungen
Un côté avec douille tournante
Conforme aux exigences en
matière d'eau potable
EN1113













SHOWER

| | EAN-Nr. no EAN | Artikel Nr. no d'article | Beschreibung description | VPE ce | VE ue | UVP pro Stk. PVC CHF excl. | UVP pro Stk. PVC CHF incl. |
|--|-------------------|-----------------------------|-----------------------------|-----------|----------|----------------------------------|----------------------------------|
|--|-------------------|-----------------------------|-----------------------------|-----------|----------|----------------------------------|----------------------------------|

| Kunststoffbrauseschlauch | | Flexible douche en plastique | | | | | |
|---|--|-------------------------------------|---|---|---|--------------|--------------|
|  |  7 611038 243500 | 05 4618 98 | verchromt/6-kant x DK chromé/6-pans x DT 1/2" ; 180 cm | 5 |  | 15.84 | 17.06 |
| |  7 611038 243524 | 05 4818 98 | schwarz/chrom/6-kant x DK noir/chromé/6-pans x DT 1/2" ; 180 cm | 5 |  | 15.84 | 17.06 |
| |  7 611038 243548 | 05 5018 98 | weiss/6-kant x DK blanc/6-pans x DT 1/2" ; 180 cm | 5 |  | 15.84 | 17.06 |



Einseitig mit Verdrehsicherung
Erfüllt
Trinkwasseranforderungen
Un côté avec douille tournante
Conforme aux exigences en
matière d'eau potable









| Brauseschlauch Spiral | | Flexible de douche Spiral | | | | | |
|---|--|----------------------------------|---|---|---|--------------|--------------|
|  |  7 611038 243579 | 05 6815 98 | schwarz/chrom/6-kant x DK noir/chromé/6-pans x DT 1/2" ; 150 cm | 5 |  | 33.55 | 36.13 |
| |  7 611038 243586 | 05 6818 98 | schwarz/chrom/6-kant x DK noir/chromé/6-pans x DT 1/2" ; 180 cm | 5 |  | 36.81 | 39.65 |
| |  7 611038 245375 | 05 6820 98 | schwarz/chrom/6-kant x DK noir/chromé/6-pans x DT 1/2" ; 200 cm | 5 |  | 41.47 | 44.67 |
| |  7 611038 834920 | 06 4325 96 | schwarz/chrom/6-kant x DK noir/chromé/6-pans x DT 1/2" ; 250 cm | 1 |  | 43.80 | 47.17 |
| |  7 611038 834937 | 06 4330 96 | schwarz/chrom/6-kant x DK noir/chromé/6-pans x DT 1/2" ; 300 cm | 1 |  | 47.53 | 51.19 |











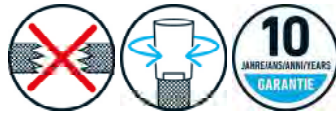

Einseitig mit Verdrehsicherung
Erfüllt
Trinkwasseranforderungen
Un côté avec douille tournante
Conforme aux exigences en
matière d'eau potable
EN1113

SHOWER

| EAN-Nr. no EAN | Artikel Nr. no d'article | Beschreibung description | VPE ce | VE ue | UVP pro Stk. PVC CHF excl. | UVP pro Stk. PVC CHF incl. |
|-------------------|-----------------------------|-----------------------------|-----------|----------|----------------------------------|----------------------------------|
|-------------------|-----------------------------|-----------------------------|-----------|----------|----------------------------------|----------------------------------|

| Metallbrauseschlauch Fortaflex | | Flexible en métal Fortaflex | | | | | |
|---|--|-----------------------------|--|---|---|--------------|--------------|
|  <p>Metallbrauseschlauch mit PVC-freiem Innenschlauch. Hochwertig und hygienisch unbedenklich. Einseitig mit Verdrehsicherung. Erfüllt Trinkwasseranforderungen Flexible de douche en métal avec tube intérieur sans PVC. De grande qualité et irréprochable sur le plan de l'hygiène. Un côté avec douille tournante Conforme aux exigences en matière d'eau potable EN1113</p> |  7 611038 172923 | 05 2208 94 | verchromt / K x DK / PVC-frei chromé / D x DT / sans PVC 1/2" ; 80 cm | 1 |  | 10.81 | 11.64 |
| |  7 611038 174774 | 05 2215 98 | verchromt / K x DK / PVC-frei chromé / D x DT / sans PVC 1/2" ; 150CM | 5 |  | 14.82 | 15.96 |
| |  7 611038 174071 | 05 2218 98 | verchromt / K x DK / PVC-frei chromé / D x DT / sans PVC 1/2" ; 180 cm | 5 |  | 16.87 | 18.17 |
| |  7 611038 174088 | 05 2220 98 | verchromt / K x DK / PVC-frei chromé / D x DT / sans PVC 1/2" ; 200 cm | 5 |  | 18.64 | 20.07 |



| Metallbrauseschlauch Fortaflex | | Flexible en métal Fortaflex | | | | | |
|--|--|-----------------------------|--|----|---|--------------|--------------|
|  <p>Einseitig mit Verdrehsicherung Erfüllt Trinkwasseranforderungen Un côté avec douille tournante Conforme aux exigences en matière d'eau potable EN1113</p> |  7 611038 243784 | 05 9310 98 | verchromt/6-kant x DK chromé/6-pans x DT 1/2" ; 100 cm | 5 |  | 33.08 | 35.63 |
| |  7 611038 243791 | 05 9315 98 | verchromt/6-kant x DK chromé/6-pans x DT 1/2" ; 150 cm | 5 |  | 35.41 | 38.14 |
| |  7 611038 243807 | 05 9318 98 | verchromt/6-kant x DK chromé/6-pans x DT 1/2" ; 180 cm | 5 |  | 37.74 | 40.65 |
| |  7 611038 116989 | 06 0420 96 | verchromt/6-kant x DK chromé/6-pans x DT 1/2" ; 200 cm | 50 |  | 37.74 | 40.65 |

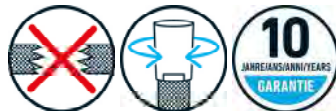

SHOWER

| EAN-Nr. no EAN | Artikel Nr. no d'article | Beschreibung description | VPE ce | VE ue | UVP pro Stk. PVC CHF excl. | UVP pro Stk. PVC CHF incl. |
|-------------------|-----------------------------|-----------------------------|-----------|----------|----------------------------------|----------------------------------|
|-------------------|-----------------------------|-----------------------------|-----------|----------|----------------------------------|----------------------------------|

| Metallbrauseschlauch PVC-frei | | Flexible en métal sans PVC | | | | |
|-------------------------------|--|----------------------------|--|--|--|--|
|-------------------------------|--|----------------------------|--|--|--|--|



Metallbrauseschlauch mit PVC-freiem Innenschlauch. Hochwertig und hygienisch unbedenklich. Einseitig mit Verdrehsicherung.

Erfüllt Trinkwasseranforderungen
Flexible de douche en métal avec tube intérieur sans PVC. De grande qualité et irréprochable sur le plan de l'hygiène. Un côté avec douille tournante
Conforme aux exigences en matière d'eau potable EN1113

| | | | | | | |
|--|-------------------|--|---|--|--------------|--------------|
| | 05 2108 96 | verchromt / 6-kant x DK chromé/6-pans x DT 1/2" ; 80 cm | 1 | | 11.93 | 12.85 |
| | 05 2115 98 | verchromt / 6-kant x DK chromé/6-pans x DT 1/2" ; 150 cm | 5 | | 12.86 | 13.85 |
| | 05 2118 98 | verchromt / 6-kant x DK chromé/6-pans x DT 1/2" ; 180 cm | 5 | | 14.82 | 15.96 |
| | 05 2120 98 | verchromt / 6-kant x DK chromé/6-pans x DT 1/2" ; 200 cm | 5 | | 16.87 | 18.17 |



| Metallbrauseschlauch PVC-frei | | Flexible en métal sans PVC | | | | |
|-------------------------------|--|----------------------------|--|--|--|--|
|-------------------------------|--|----------------------------|--|--|--|--|



Metallbrauseschlauch mit PVC-freiem Innenschlauch. Hochwertig und hygienisch unbedenklich.

Erfüllt Trinkwasseranforderungen
Flexible de douche en métal avec tube intérieur sans PVC. De grande qualité et irréprochable sur le plan de l'hygiène.
Conforme aux exigences en matière d'eau potable EN1113

| | | | | | | |
|--|-------------------|--|---|--|--------------|--------------|
| | 05 2015 96 | poliert / Rändel ABS x K ABS poli/moleté ABS x D ABS 1/2" ; 150 cm | 1 | | 7.69 | 8.28 |
| | 05 2018 98 | poliert / Rändel ABS x K ABS poli/moleté ABS x D ABS 1/2" ; 180CM | 5 | | 9.88 | 10.64 |
| | 05 2020 96 | poliert / Rändel ABS x K ABS poli/moleté ABS x D ABS 1/2" ; 200 cm | 1 | | 10.07 | 10.84 |



| Silikondichtung zu Brauseschl. | | Joint silicone p.tuyaux douche | | | | |
|--------------------------------|--|--------------------------------|--|--|--|--|
|--------------------------------|--|--------------------------------|--|--|--|--|

Für Auszugschläuche
Pour flexibles de cuisine

| | | | | | | |
|--|-------------------|---|---|--|-------------|-------------|
| | 78 1311 96 | Beutel zu 10 Stk. Sachet à 10 pcs 1/2" ; 10.2 x 20 x 2 mm | 1 | | 5.45 | 5.87 |
|--|-------------------|---|---|--|-------------|-------------|

Gleitstangen

Glissières de douche

| EAN-Nr. no EAN | Artikel Nr. no d'article | Beschreibung description | VPE ce | VE ue | UVP pro Stk. PVC CHF excl. | UVP pro Stk. PVC CHF incl. |
|-------------------|-----------------------------|-----------------------------|-----------|----------|----------------------------------|----------------------------------|
|-------------------|-----------------------------|-----------------------------|-----------|----------|----------------------------------|----------------------------------|

| Duschgleitstange | Glissière de douche |
|------------------|---------------------|
|------------------|---------------------|



| | | | | | | |
|--|-------------------|---|---|--|---------------|---------------|
| | 05 9561 97 | verchromt chromé Ø 18 mm ; 61 cm | 1 | | 167.75 | 180.67 |
| | 05 9562 97 | verchromt chromé Ø 18 mm ; 110 cm | 1 | | 177.07 | 190.71 |

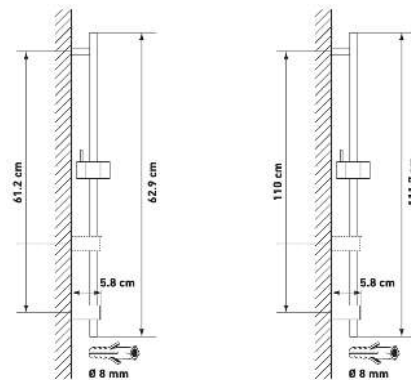

| Gleiter zu Duschgleitstange | Support coulissant p/glissière |
|-----------------------------|--------------------------------|
|-----------------------------|--------------------------------|



| | | | | | | |
|--|-------------------|--|---|--|--------------|--------------|
| | 05 9570 98 | Messing verchromt laiton chromé Ø 18MM | 2 | | 72.69 | 78.29 |
|--|-------------------|--|---|--|--------------|--------------|



| Abdeckkappe Duschgleitstange | Cache pour glissière de douche |
|------------------------------|--------------------------------|
|------------------------------|--------------------------------|



| | | | | | | |
|--|-------------------|--|---|--|--------------|--------------|
| | 05 9571 98 | chromeline/2 Stück chromeline/2 pièces Ø 20 mm | 3 | | 10.07 | 10.84 |
|--|-------------------|--|---|--|--------------|--------------|



Gleitstangen

Glissières de douche









NEW

| EAN-Nr. no EAN | Artikel Nr. no d'article | Beschreibung description | VPE ce | VE ue | UVP pro Stk. PVC CHF excl. | UVP pro Stk. PVC CHF incl. |
|-------------------|-----------------------------|-----------------------------|-----------|----------|----------------------------------|----------------------------------|
|-------------------|-----------------------------|-----------------------------|-----------|----------|----------------------------------|----------------------------------|

Duschgleitstange Faido

Glissière de douche Faido



| | | | | | | |
|--|-------------------|--|----|---|--------------|---------------|
|  7 611038 679255 | 05 9689 97 | verchromt chromé 61 cm ; Ø 18 mm | 1 |  | 89.47 | 96.36 |
|  7 611038 388386 | 05 9703 97 | schwarz matt noir mat 61 cm ; Ø 18 mm | 1 |  | 89.47 | 96.36 |
|  7 611038 408701 | 05 9690 97 | verchromt chromé 110 cm ; Ø 18 mm | 15 |  | 99.72 | 107.40 |
|  7 611038 388393 | 05 9704 97 | schwarz matt noir mat 110 cm ; Ø 18 mm | 1 |  | 99.72 | 107.40 |

- Metall, verchromt/ schwarz matt
- Brausehalter mit Fingerdruck verstellbar und automatischer Arretierung
- Massive Ausführung
- Verdeckte Montage
- Inkl. Dübel und Schrauben
- Métal, chromé/ noir mat
- Support de douche à réglage par simple pression du doigt, et à arrêt automatique
- Exécution massive
- Fixation invisible
- Chevilles et vis comprises

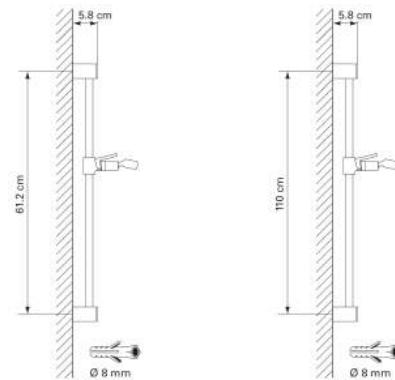

Gleiter zu Duschgleitstange

Support coulissant p/glissière

| | | | | | | |
|--|-------------------|-------------------------------------|---|---|--------------|--------------|
|  7 611038 188955 | 05 9690 90 | verchromt chromé Ø 18 mm | 0 |  | 23.30 | 25.09 |
|  7 611038 388409 | 05 9704 90 | schwarz matt noir mat Ø 18 mm | 0 |  | 23.30 | 25.09 |

Konsole Duschgleitstange Faido

Consoles pour glissière Faido

| | | | | | | |
|--|-------------------|-------------------------------------|---|---|--------------|--------------|
|  7 611038 188962 | 05 9690 91 | verchromt chromé Ø 18 mm | 0 |  | 17.71 | 19.07 |
|  7 611038 388638 | 05 9704 91 | schwarz matt noir mat Ø 18 mm | 1 |  | 17.71 | 19.07 |

Gleitstangen



Glissières de douche

| | EAN-Nr. <i>no EAN</i> | Artikel Nr. <i>no d'article</i> | Beschreibung <i>description</i> | VPE <i>ce</i> | VE <i>ue</i> | UVP pro Stk. <i>PVC</i> CHF excl. | UVP pro Stk. <i>PVC</i> CHF incl. |
|--------------------------------------|--|---------------------------------------|---|------------------|---|---|---|
| Abdeckkappe Gleitstange Faido | | Cache p/glissière douche Faido | | | | | |
| |  7 611038 188986 | 05 9690 93 | verchromt <i>chromé</i> | 0 |  | 3.45 | 3.71 |
| |  7 611038 388416 | 05 9704 93 | schwarz matt <i>noir mat</i> | 0 |  | 3.45 | 3.71 |
| Befestigungsset Faido | | Set de fixation Faido | | | | | |
| |  7 611038 188979 | 05 9690 92 | mit Schrauben und Dübel <i>avec visses & chevilles</i> | 0 |  | 17.71 | 19.07 |



Gleitstangen



Glissières de douche

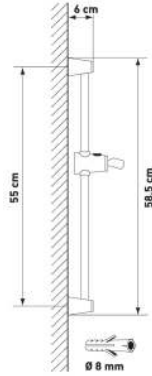

| EAN-Nr. no EAN | Artikel Nr. no d'article | Beschreibung description | VPE ce | VE ue | UVP pro Stk. PVC CHF excl. | UVP pro Stk. PVC CHF incl. |
|-------------------|-----------------------------|-----------------------------|-----------|----------|----------------------------------|----------------------------------|
|-------------------|-----------------------------|-----------------------------|-----------|----------|----------------------------------|----------------------------------|

| Duschgleitstange konisch | | Glissière douche conique | | | | | |
|---|---|--------------------------|---|---|---|---------------|---------------|
|  |  | 05 9697 97 | Messing verchromt laiton chromé Ø 18MM ; 55CM | 3 |  | 102.51 | 110.41 |



| Gleiter z/Duschgleits. konisch | | Support coulissant conique | | | | | |
|--|--|----------------------------|---------------------------------------|---|--|--------------|--------------|
|  |  | 05 9583 98 | ABS verchromt ABS chromé Ø 18MM | 1 |  | 75.49 | 81.30 |

| Konsolen Duschgleits. konisch | | Fix. murale glissière conique | | | | | |
|---|---|-------------------------------|---------------------|---|---|--------------|--------------|
|  |  | 05 9584 98 | verchromt chromé | 1 |  | 36.81 | 39.65 |

| Sockelkappe Duschgleitstange | | Cache pour glissière de douche | | | | | |
|---|---|--------------------------------|---|---|---|-------------|-------------|
|  |  | 08 3301 98 | ABS verchromt/2 Stück ABS chromé/2 pièces Ø 25 mm | 5 |  | 3.96 | 4.27 |

ZU:
pour:
05 9695 97, 05 9696 97
05 9697 97 & 05 9698 97

Gleitstangen

Glissières de douche

NEW

| EAN-Nr. no EAN | Artikel Nr. no d'article | Beschreibung description | VPE ce | VE ue | UVP pro Stk. PVC CHF excl. | UVP pro Stk. PVC CHF incl. |
|-------------------|-----------------------------|-----------------------------|-----------|----------|----------------------------------|----------------------------------|
|-------------------|-----------------------------|-----------------------------|-----------|----------|----------------------------------|----------------------------------|

Duschgleitstange Parsa

Glissière de douche Parsa



05 9694 97

Edelstahl verchromt
acier raffiné chromé
Ø 18MM ; 116 cm

1



34.95

37.64



05 9702 97

Edelstahl schwarz matt
acier raffiné noir mat
Ø 18MM ; 116 cm

1



34.95

37.64

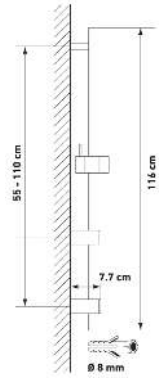

Bestehende Bohrlöcher
verwendbar, kompatibel zu
Duschgleitstangen KWC,
SIMILOR / ARWA.
Trous existants réutilisables
compatibles aux glissières KWC,
SIMILOR / ARWA.

Gleiter z/Duschgleitst. Parsa

Support coulissant Parsa



05 9692 94

ABS verchromt
ABS chromé
Ø 18MM

1



37.74

40.65



05 9702 94

ABS schwarz matt
ABS noir mat
Ø 18MM

1



37.74

40.65

Konsole Duschgleitstange Parsa

Consoles pour glissière Parsa



05 9692 96

ABS verchromt
ABS chromé
Ø 18MM

1



13.14

14.15



05 9702 96

ABS schwarz matt
ABS noir mat
Ø 18MM

1





13.14

14.15

Gleitstangen

Glissières de douche

| EAN-Nr. no EAN | Artikel Nr. no d'article | Beschreibung description | VPE ce | VE ue | UVP pro Stk. PVC CHF excl. | UVP pro Stk. PVC CHF incl. |
|-------------------|-----------------------------|-----------------------------|-----------|----------|----------------------------------|----------------------------------|
|-------------------|-----------------------------|-----------------------------|-----------|----------|----------------------------------|----------------------------------|

| Duschgleitstange m/Saugnapfen | | Glissière douche avec ventouse | | | | | |
|---|--|--------------------------------|--|----|---|--------------|--------------|
|  |  7 611038 243999 | 05 9693 97 | Rohr Edelstahl verchromt tube acier raffiné chromé Ø 24 mm ; 60 cm | 15 |  | 49.39 | 53.20 |

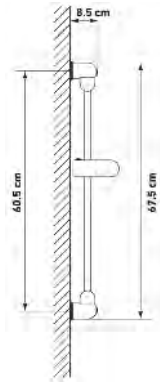



Duschsysteme

Systemes de douche

Umsteller Push

Inverseur Push



Mittels Knopfdruck kann der Wasserstrahl einfach zwischen Kopf- und Duschbrause gewechselt werden.

Une simple pression sur un bouton permet d'alterner le jet d'eau entre la douche de tête et la douche.



Umsteller Turn

Inverseur Turn

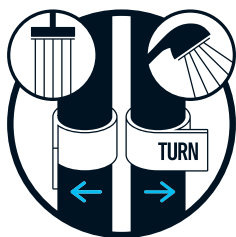

Mittels Drehumsteller kann der Wasserstrahl zwischen Kopf- und Duschbrause gewechselt werden.

L'inverseur rotatif permet d'alterner le jet d'eau entre la douche de tête et la douche.



Entleerventil

Vanne de vidange



Das übriggebliebene Wasser kann nach dem Duschen durch das Entleerventil austropfen. Dadurch erhöht sich die Lebensdauer des Schlauches, hilft zur Vermeidung von Bakterienbildung und stoppt das Nachtropfen aus der Kopf- und Duschbrause.

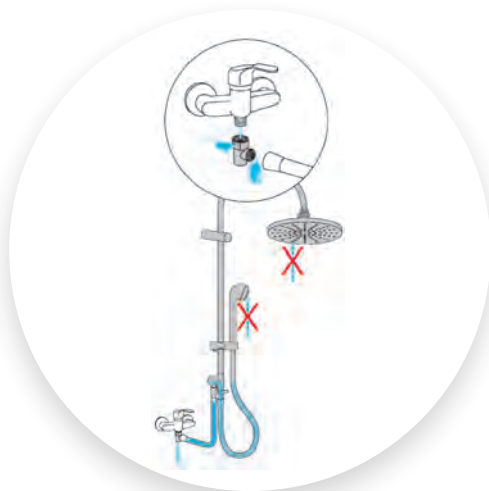

L'eau restante peut s'égoutter après la douche grâce à la vanne de vidange. Cela augmente la durée de vie du tuyau, aide à éviter la formation de bactéries et arrête le dégouttement de la pomme de douche et de la douche.



Duschsysteme Turn

Systèmes de douche Turn

| EAN-Nr. no EAN | Artikel Nr. no d'article | Beschreibung description | VPE ce | VE ue | UVP pro Stk. PVC CHF excl. | UVP pro Stk. PVC CHF incl. |
|-------------------|-----------------------------|-----------------------------|-----------|----------|----------------------------------|----------------------------------|
|-------------------|-----------------------------|-----------------------------|-----------|----------|----------------------------------|----------------------------------|

| Duschsystem Ymir Turn | | Système de douche Ymir Turn | | | | |
|---|--|-----------------------------|---|---|---|-----------------------------|
|  |  7 611038 570484 | 08 3517 97 | verchromt chromé 125 cm / 1 Strahl/Jet ; EK: C / 72 | 1 |  | 174.28 187.69 |

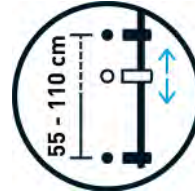
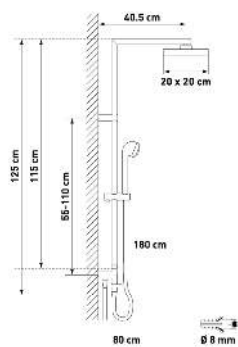

Montierbar auf bestehende Bohrlöcher für Duschen und Badewannen.

Bestehend aus:

- Kopfbrause (20 x 20cm)
- Duschbrause (1 Strahl)
- 2 Kunststoffbrauseschläuche CHROMALUX® Zero PVC-Frei (80 & 180cm)
- Wasserführende Duschgleitstange (Ø 25 mm)

Erfüllt



Trinkwasseranforderungen

Montage possible dans les trous existants des appareils précédents.

Composition:

- Pomme de douche (20 x 20cm)
- Poignée de douche (1 jet)
- 2 flexibles de douche plastique CHROMALUX® Supreme sans PVC (80 & 180cm)
- Glissière de douche aquifère (Ø 25 mm)

Conforme aux exigences en matière d'eau potable

| Kopfbrause Ruud | | Pomme de douche Ruud | | | | |
|---|--|----------------------|---|---|---|---------------------------|
|  |  7 611038 570262 | 05 9418 97 | verchromt chromé ½" / 1 Strahl/Jet ; EK: D / 200 x 200 mm | 1 |  | 38.68 41.65 |

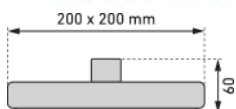

Erfüllt

Trinkwasseranforderungen

Conforme aux exigences en matière d'eau potable

Duschsysteme Turn

Systèmes de douche Turn

| EAN-Nr. no EAN | Artikel Nr. no d'article | Beschreibung description | VPE ce | VE ue | UVP pro Stk. PVC CHF excl. | UVP pro Stk. PVC CHF incl. |
|-------------------|-----------------------------|-----------------------------|-----------|----------|----------------------------------|----------------------------------|
|-------------------|-----------------------------|-----------------------------|-----------|----------|----------------------------------|----------------------------------|

Brausegriff Novogreen

Shower handle Novogreen



06 2100 96

verchromt
chrome-plated
1/2" / 1 Strahl/Jet

1



20.97

22.58

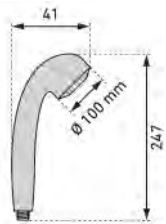



Erfüllt
Trinkwasseranforderungen
Conforme aux exigences en
matière d'eau potable

Duschsysteme Turn

Systèmes de douche Turn

| EAN-Nr. no EAN | Artikel Nr. no d'article | Beschreibung description | VPE ce | VE ue | UVP pro Stk. PVC CHF excl. | UVP pro Stk. PVC CHF incl. |
|-------------------|-----------------------------|-----------------------------|-----------|----------|----------------------------------|----------------------------------|
|-------------------|-----------------------------|-----------------------------|-----------|----------|----------------------------------|----------------------------------|

| Duschsystem Naiad Turn | | Système de douche Naiad Turn | | | | |
|---|-------------------|--|---|---|---------------|---------------|
|  | 08 3515 97 | verchromt chromé 120 cm / 3 Strahl/Jets ; EK: C / 70 | 1 |  | 193.85 | 208.77 |

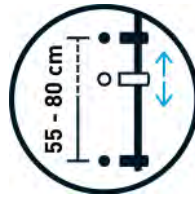
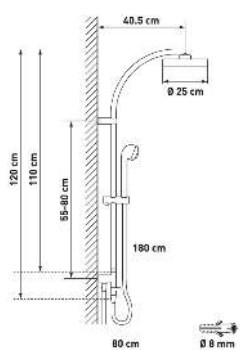

Montierbar auf bestehende Bohrlöcher für Duschen und Badewannen.

Bestehend aus:

- Kopfbrause (Ø 25cm)
- Duschbrause (3 Strahl)
- 2 Kunststoffbrauseschläuche CHROMALUX® Zero PVC-Frei (80 & 180cm)
- Wasserführende Duschgleitstange (Ø 25 mm)

Erfüllt



Trinkwasseranforderungen

Montage possible dans les trous existants des appareils précédents.

Composition:

- Pomme de douche (Ø 25cm)
- Poignée de douche (1 jet)
- 2 flexibles de douche plastique CHROMALUX® Zero sans PVC (80 & 180cm)
- Glissière de douche aquifère (Ø 25 mm)

Conforme aux exigences en matière d'eau potable

| Kopfbrause Runda | | Pomme de douche Runda | | | | |
|---|-------------------|---|---|---|--------------|--------------|
|  | 05 9419 97 | verchromt chromé 1/2" / 1 Strahl/Jet ; EK: D / Ø 250 mm | 1 |  | 38.68 | 41.65 |

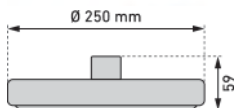

Erfüllt

Trinkwasseranforderungen

Conforme aux exigences en matière d'eau potable

Duschsysteme Turn

Systèmes de douche Turn

| EAN-Nr. no EAN | Artikel Nr. no d'article | Beschreibung description | VPE ce | VE ue | UVP pro Stk. PVC CHF excl. | UVP pro Stk. PVC CHF incl. |
|-------------------|-----------------------------|-----------------------------|-----------|----------|----------------------------------|----------------------------------|
|-------------------|-----------------------------|-----------------------------|-----------|----------|----------------------------------|----------------------------------|

Duschbrause Hera PCR

Poignée douche Hera PCR



05 9846 98

verchromt
chromé
1/2" / 3 Strahl/Jets ; EK: C / ~
10 l/min

3



27.03

29.11

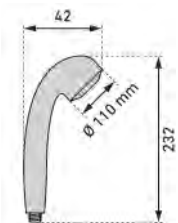



Erfüllt
Trinkwasseranforderungen
Conforme aux exigences en
matière d'eau potable

Duschsysteme Turn

Systèmes de douche Turn

| EAN-Nr. no EAN | Artikel Nr. no d'article | Beschreibung description | VPE ce | VE ue | UVP pro Stk. PVC CHF excl. | UVP pro Stk. PVC CHF incl. |
|-------------------|-----------------------------|-----------------------------|-----------|----------|----------------------------------|----------------------------------|
|-------------------|-----------------------------|-----------------------------|-----------|----------|----------------------------------|----------------------------------|

| Duschsystem Herse Turn | | Système de douche Herse Turn | | | | | |
|---|--|------------------------------|--|---|---|---------------|---------------|
|  |  7 611038 570477 | 08 3516 97 | verchromt chromé 120 cm / 3 Strahl/Jets ; EK: C / 71 | 1 |  | 213.42 | 229.85 |

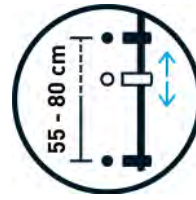
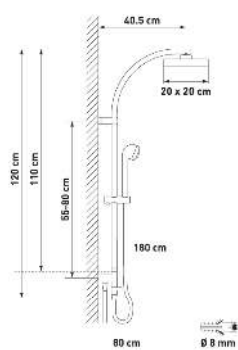

Montierbar auf bestehende Bohrlöcher für Duschen und Badewannen.

Bestehend aus:

- Kopfbrause (20 x 20cm)
- Duschbrause (3 Strahl)
- 2 Kunststoffbrauseschläuche CHROMALUX® Zero PVC-Frei (80 & 180cm)
- Wasserführende Duschgleitstange (Ø 25 mm)

Erfüllt



Trinkwasseranforderungen

Montage possible dans les trous existants des appareils précédents.

Composition:

- Pomme de douche (Ø 25cm)
- Poignée de douche (1 jet)
- 2 flexibles de douche plastique CHROMALUX® Zero sans PVC (80 & 180cm)
- Glissière de douche aquifère (Ø 25 mm)

Conforme aux exigences en matière d'eau potable

| Kopfbrause Ruud | | Pomme de douche Ruud | | | | | |
|---|--|----------------------|---|---|---|--------------|--------------|
|  |  7 611038 570262 | 05 9418 97 | verchromt chromé ½" / 1 Strahl/Jet ; EK: D / 200 x 200 mm | 1 |  | 38.68 | 41.65 |

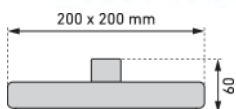

Erfüllt

Trinkwasseranforderungen

Conforme aux exigences en matière d'eau potable

Duschsysteme Turn

Systèmes de douche Turn

| EAN-Nr. no EAN | Artikel Nr. no d'article | Beschreibung description | VPE ce | VE ue | UVP pro Stk. PVC CHF excl. | UVP pro Stk. PVC CHF incl. |
|-------------------|-----------------------------|-----------------------------|-----------|----------|----------------------------------|----------------------------------|
|-------------------|-----------------------------|-----------------------------|-----------|----------|----------------------------------|----------------------------------|

Brausegriff Novolence Plus

Poignée douche Novolence Plus



06 2103 96

verchromt
chromé
1/2" / 3 Strahl/Jets

30



34.95

37.64

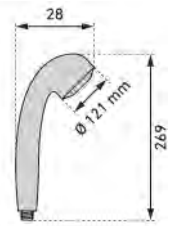



Erfüllt
Trinkwasseranforderungen
Conforme aux exigences en
matière d'eau potable

Duschsysteme Turn

Systèmes de douche Turn

| EAN-Nr. no EAN | Artikel Nr. no d'article | Beschreibung description | VPE ce | VE ue | UVP pro Stk. PVC CHF excl. | UVP pro Stk. PVC CHF incl. |
|-------------------|-----------------------------|-----------------------------|-----------|----------|----------------------------------|----------------------------------|
|-------------------|-----------------------------|-----------------------------|-----------|----------|----------------------------------|----------------------------------|

| Duschsystem Pandia Turn | | Système de douche Pandia Turn | | | | |
|---|--|-------------------------------|---|---|---|-----------------------------|
|  |  7 611038 570453 | 08 3514 97 | verchromt chromé 125 cm / 1 Strahl/Jet ; EK: C / 69 | 1 |  | 213.42 229.85 |

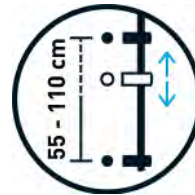
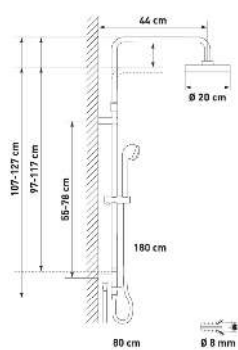

Montierbar auf bestehende Bohrlöcher für Duschen und Badewannen.

Bestehend aus:

- Kopfbrause (Ø 20cm)
- Duschbrause (1 Strahl)
- 2 Metallbrauseschläuche PVC-Frei (80 & 180cm)
- Wasserführende Duschgleitstange (Ø 25 mm)

Erfüllt



Trinkwasseranforderungen

Montage possible dans les trous existants des appareils précédents.

Composition:

- Pomme de douche (Ø 20cm)
- Poignée de douche (1 jet)
- 2 flexibles de douche métallique sans PVC (80 & 180cm)
- Glissière de douche aquifère (Ø 25 mm)

Conforme aux exigences en matière d'eau potable

| Kopfbrause Pandia | | Pomme de douche Pandia | | | | |
|---|--|------------------------|---|---|---|---------------------------|
|  |  7 611038 570576 | 05 9421 96 | verchromt chromé 1/2" / 1 Strahl/Jet ; Ø 200 mm | 1 |  | 28.89 31.12 |

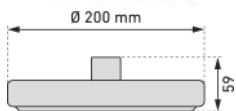
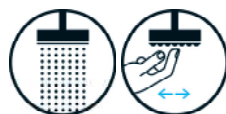

Erfüllt

Trinkwasseranforderungen

Conforme aux exigences en matière d'eau potable

Duschsysteme Turn

Systèmes de douche Turn

| EAN-Nr. no EAN | Artikel Nr. no d'article | Beschreibung description | VPE ce | VE ue | UVP pro Stk. PVC CHF excl. | UVP pro Stk. PVC CHF incl. |
|-------------------|-----------------------------|-----------------------------|-----------|----------|----------------------------------|----------------------------------|
|-------------------|-----------------------------|-----------------------------|-----------|----------|----------------------------------|----------------------------------|

Duschbrause Monoton PCR

Poignée de douche Monoton PCR



05 9930 98

verchromt
chromé
1/2" / 1 Strahl/Jet ; EK: C / ~ 10
l/min

3



16.87

18.17

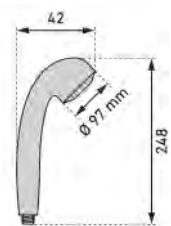



Erfüllt
Trinkwasseranforderungen
Conforme aux exigences en
matière d'eau potable

Duschsysteme Turn

Systèmes de douche Turn

| EAN-Nr. no EAN | Artikel Nr. no d'article | Beschreibung description | VPE ce | VE ue | UVP pro Stk. PVC CHF excl. | UVP pro Stk. PVC CHF incl. |
|-------------------|-----------------------------|-----------------------------|-----------|----------|----------------------------------|----------------------------------|
|-------------------|-----------------------------|-----------------------------|-----------|----------|----------------------------------|----------------------------------|

| Duschsystem Charon Turn | | Système de douche Charon Turn | | | | |
|---|-------------------|--|---|---|---------------|---------------|
|  | 08 3518 97 | verchromt chromé 125 cm / 3 Strahl/Jets ; EK: C / 73 | 1 |  | 232.06 | 249.92 |

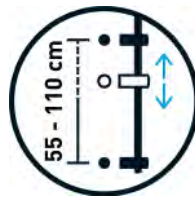
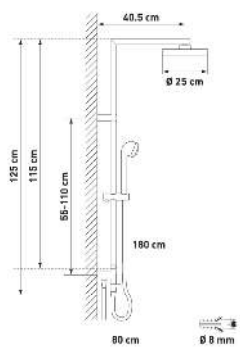

Montierbar auf bestehende Bohrlöcher für Duschen und Badewannen.

Bestehend aus:

- Kopfbrause (Ø 25cm)
- Duschbrause (3 Strahl)
- 2 Kunststoffbrauseschläuche CHROMALUX® Zero PVC-Frei (80 & 180cm)
- Wasserführende Duschgleitstange (Ø 25 mm)

Erfüllt



Trinkwasseranforderungen

Montage possible dans les trous existants des appareils précédents.

Composition:

- Pomme de douche (Ø 25cm)
- Poignée de douche (3 jets)
- 2 flexibles de douche plastique CHROMALUX® Zero sans PVC (80 & 180cm)
- Glissière de douche aquifère (Ø 25 mm)

Conforme aux exigences en matière d'eau potable

| Kopfbrause Runda | | Pomme de douche Runda | | | | |
|---|-------------------|---|---|---|--------------|--------------|
|  | 05 9419 97 | verchromt chromé ½" / 1 Strahl/Jet ; EK: D / Ø 250 mm | 1 |  | 38.68 | 41.65 |

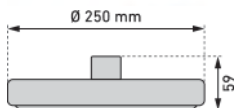

Erfüllt

Trinkwasseranforderungen

Conforme aux exigences en matière d'eau potable

Duschsysteme Turn

Systèmes de douche Turn

| EAN-Nr. no EAN | Artikel Nr. no d'article | Beschreibung description | VPE ce | VE ue | UVP pro Stk. PVC CHF excl. | UVP pro Stk. PVC CHF incl. |
|-------------------|-----------------------------|-----------------------------|-----------|----------|----------------------------------|----------------------------------|
|-------------------|-----------------------------|-----------------------------|-----------|----------|----------------------------------|----------------------------------|

Duschbrause Dike PCR

Poignée douche Dike PCR



05 9831 98

verchromt
chromé
1/2" / 3 Strahl/Jets ; EK: B / ~ 7
l/min

3



34.02

36.64

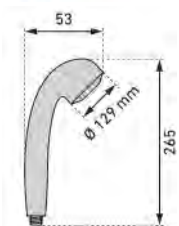

Gleiter zu Duschsystemen

Supp. coulissant syst. douche



08 3500 94

verchromt
chromé
Ø 25 mm

1



14.07

15.16

Umsteller zu Duschsystemen

Inverseur pour systèmes douche



08 3500 93

verchromt
chromé

1



72.69

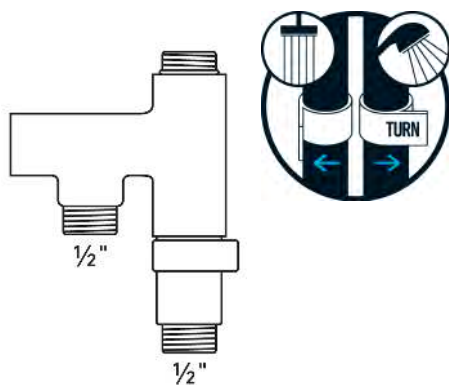

78.29





Duschsysteme Turn









Systèmes de douche Turn

| EAN-Nr. no EAN | Artikel Nr. no d'article | Beschreibung description | VPE ce | VE ue | UVP pro Stk. PVC CHF excl. | UVP pro Stk. PVC CHF incl. |
|-------------------|-----------------------------|-----------------------------|-----------|----------|----------------------------------|----------------------------------|
|-------------------|-----------------------------|-----------------------------|-----------|----------|----------------------------------|----------------------------------|

| Konsole zu Duschsystemen | | Fix. murale p. systèmes douche | | | | | |
|---|--|--------------------------------|--------------------------------|---|---|--------------|--------------|
|  |  7 611038 181949 | 08 3500 95 | verchromt chromé Ø 25 mm | 1 |  | 21.90 | 23.59 |



| Montagebeutel zu Duschsystemen | | Sachet montage p/system douche | | | | | |
|---|--|--------------------------------|-------|---|---|-------------|--------------|
|  |  7 611038 182205 | 08 3500 96 | Ø 8MM | 1 |  | 9.79 | 10.54 |

| Metallbrauseschlauch Fortaflex | | Flexible en métal Fortaflex | | | | | |
|---|--|-----------------------------|--|---|---|--------------|--------------|
|  |  7 611038 172923 | 05 2208 94 | verchromt / K x DK / PVC-frei chromé / D x DT / sans PVC 1/2" ; 80 cm | 1 |  | 10.81 | 11.64 |
| |  7 611038 174774 | 05 2215 98 | verchromt / K x DK / PVC-frei chromé / D x DT / sans PVC 1/2" ; 150CM | 5 |  | 14.82 | 15.96 |
| |  7 611038 174071 | 05 2218 98 | verchromt / K x DK / PVC-frei chromé / D x DT / sans PVC 1/2" ; 180 cm | 5 |  | 16.87 | 18.17 |
| |  7 611038 174088 | 05 2220 98 | verchromt / K x DK / PVC-frei chromé / D x DT / sans PVC 1/2" ; 200 cm | 5 |  | 18.64 | 20.07 |

Metallbrauseschlauch mit PVC-freiem Innenschlauch.
Hochwertig und hygienisch unbedenklich. Einseitig mit Verdrehsicherung.

Erfüllt Trinkwasseranforderungen
Flexible de douche en métal avec tube intérieur sans PVC. De grande qualité et irréprochable sur le plan de l'hygiène. Un côté avec douille tournante
Conforme aux exigences en matière d'eau potable EN1113

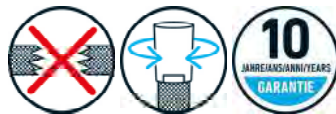

Duschsysteme Turn

Systemes de douche Turn

| EAN-Nr. no EAN | Artikel Nr. no d'article | Beschreibung description | VPE ce | VE ue | UVP pro Stk. PVC CHF excl. | UVP pro Stk. PVC CHF incl. |
|-------------------|-----------------------------|-----------------------------|-----------|----------|----------------------------------|----------------------------------|
|-------------------|-----------------------------|-----------------------------|-----------|----------|----------------------------------|----------------------------------|

Brauseschl. CHROMALUX® Zero

Flexible CHROMALUX® Zero



| | | | | | | |
|-----------------|-------------------|---|---|--|--------------|--------------|
| 4 005897 165579 | 05 7608 94 | silver grey / K x DK silver grey / D x DT 1/2" ; 80 cm | 1 | | 16.87 | 18.17 |
| 7 611038 250010 | 05 7615 98 | silver grey / K x DK silver grey / D x DT 1/2" ; 150 cm | 5 | | 16.96 | 18.27 |
| 7 611038 250027 | 05 7618 98 | silver grey / K x DK silver grey / D x DT 1/2" ; 180 cm | 5 | | 17.99 | 19.37 |
| 7 611038 250034 | 05 7620 98 | silver grey / K x DK silver grey / D x DT 1/2" ; 200 cm | 5 | | 19.11 | 20.58 |

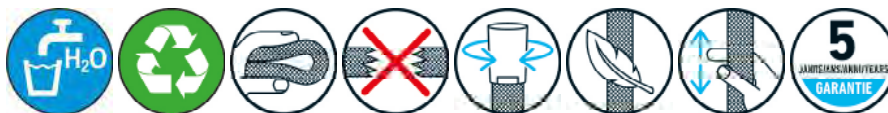



Einseitig mit Verdrehsicherung
Un côté avec douille tournante
EN1113

Duschsysteme Push

Systèmes de douche Push

| EAN-Nr. no EAN | Artikel Nr. no d'article | Beschreibung description | VPE ce | VE ue | UVP pro Stk. PVC CHF excl. | UVP pro Stk. PVC CHF incl. |
|-------------------|-----------------------------|-----------------------------|-----------|----------|----------------------------------|----------------------------------|
|-------------------|-----------------------------|-----------------------------|-----------|----------|----------------------------------|----------------------------------|

| Duschsystem Ersa LED Push | | Système douche Ersa LED Push | | | | | |
|---|--|------------------------------|--|---|---|---------------|---------------|
|  |  7 611038 570507 | 08 3519 97 | verchromt chromé 93 cm / 3 Strahl/Jet ; EK: C / 74 | 1 |  | 232.06 | 249.92 |

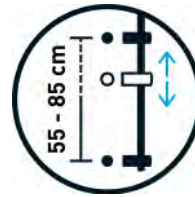
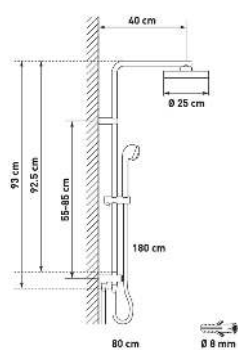

Montierbar auf bestehende Bohrlöcher für Duschen und Badewannen.

Bestehend aus:

- Kopfbrause (Ø 25cm)
- LED Duschbrause (3 Strahl)
- 2 Kunststoffbrauseschläuche CHROMALUX® Zero PVC-Frei (80 & 180cm)
- Wasserführende Duschgleitstange (Ø 25 mm)

Erfüllt



Trinkwasseranforderungen

Montage possible dans les trous existants des appareils précédents.

Composition:

- Pomme de douche (Ø 25cm)
- Poignée de douche LED (3 jets)
- 2 flexibles de douche plastique CHROMALUX® Zero sans PVC(80 & 180cm)
- Glissière de douche aquifère (Ø 25 mm)

Conforme aux exigences en matière d'eau potable

| Kopfbrause Runda | | Pomme de douche Runda | | | | | |
|---|--|-----------------------|---|---|---|--------------|--------------|
|  |  7 611038 570255 | 05 9419 97 | verchromt chromé ½" / 1 Strahl/Jet ; EK: D / Ø 250 mm | 1 |  | 38.68 | 41.65 |

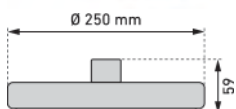

Erfüllt

Trinkwasseranforderungen

Conforme aux exigences en matière d'eau potable

Duschsysteme Push

Systèmes de douche Push

| EAN-Nr. no EAN | Artikel Nr. no d'article | Beschreibung description | VPE ce | VE ue | UVP pro Stk. PVC CHF excl. | UVP pro Stk. PVC CHF incl. |
|-------------------|-----------------------------|-----------------------------|-----------|----------|----------------------------------|----------------------------------|
|-------------------|-----------------------------|-----------------------------|-----------|----------|----------------------------------|----------------------------------|

| | |
|-----------------------------|-----------------------------------|
| Duschbrause Lich LED | Poignée de douche Lich LED |
|-----------------------------|-----------------------------------|



05 9819 98

verchromt
chromé
1/2" / 3 Strahl/Jets ; EK: C

3



36.81

39.65

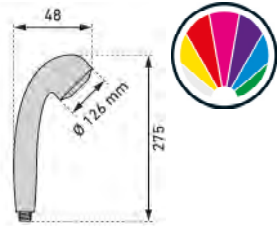

Erfüllt
Trinkwasseranforderungen
Conforme aux exigences en
matière d'eau potable

| | |
|---------------------------------|--------------------------------------|
| Gleiter zu Duschsystemen | Supp. coulissant syst. douche |
|---------------------------------|--------------------------------------|



08 3510 94

verchromt
chromé
Ø 25 mm

1



14.07

15.16

| | |
|---------------------------------------|---------------------------------------|
| Umsteller z/Duschsystemen Push | Inverseur systèmes douche Push |
|---------------------------------------|---------------------------------------|



08 3510 93

verchromt
chromé

1



72.69

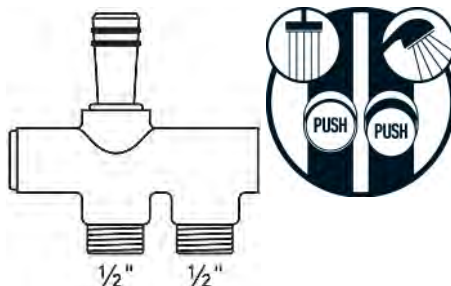

78.29





Duschsysteme Push









Systèmes de douche Push

| EAN-Nr. no EAN | Artikel Nr. no d'article | Beschreibung description | VPE ce | VE ue | UVP pro Stk. PVC CHF excl. | UVP pro Stk. PVC CHF incl. |
|-------------------|-----------------------------|-----------------------------|-----------|----------|----------------------------------|----------------------------------|
|-------------------|-----------------------------|-----------------------------|-----------|----------|----------------------------------|----------------------------------|

| Konsole zu Duschsystemen Push | | Fix. murale p. systèmes douche | | | | | |
|---|--|--------------------------------|--------------------------------|---|---|--------------|--------------|
|  |  7 611038 182229 | 08 3510 95 | verchromt chromé Ø 25 mm | 1 |  | 21.90 | 23.59 |



| Montagebeutel zu Duschsystemen | | Sachet montage p/system douche | | | | | |
|---|--|--------------------------------|-------|---|---|-------------|--------------|
|  |  7 611038 182243 | 08 3510 96 | Ø 8MM | 1 |  | 9.79 | 10.54 |

| Metallbrauseschlauch Fortaflex | | Flexible en métal Fortaflex | | | | | |
|---|--|-----------------------------|--|---|---|--------------|--------------|
|  |  7 611038 172923 | 05 2208 94 | verchromt / K x DK / PVC-frei chromé / D x DT / sans PVC 1/2" ; 80 cm | 1 |  | 10.81 | 11.64 |
| |  7 611038 174774 | 05 2215 98 | verchromt / K x DK / PVC-frei chromé / D x DT / sans PVC 1/2" ; 150CM | 5 |  | 14.82 | 15.96 |
| |  7 611038 174071 | 05 2218 98 | verchromt / K x DK / PVC-frei chromé / D x DT / sans PVC 1/2" ; 180 cm | 5 |  | 16.87 | 18.17 |
| |  7 611038 174088 | 05 2220 98 | verchromt / K x DK / PVC-frei chromé / D x DT / sans PVC 1/2" ; 200 cm | 5 |  | 18.64 | 20.07 |



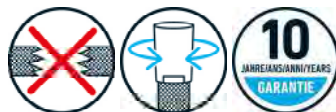





Metallbrauseschlauch mit PVC-freiem Innenschlauch.
Hochwertig und hygienisch unbedenklich. Einseitig mit Verdrehsicherung.
Erfüllt
Trinkwasseranforderungen
Flexible de douche en métal avec tube intérieur sans PVC. De grande qualité et irréprochable sur le plan de l'hygiène. Un côté avec douille tournante
Conforme aux exigences en matière d'eau potable
EN1113



Duschsysteme Push

Systemes de douche Push

| EAN-Nr. no EAN | Artikel Nr. no d'article | Beschreibung description | VPE ce | VE ue | UVP pro Stk. PVC CHF excl. | UVP pro Stk. PVC CHF incl. |
|-------------------|-----------------------------|-----------------------------|-----------|----------|----------------------------------|----------------------------------|
|-------------------|-----------------------------|-----------------------------|-----------|----------|----------------------------------|----------------------------------|

| Brauseschl. CHROMALUX® Zero | | Flexible CHROMALUX® Zero | | | | | |
|---|--|--------------------------|---|---|---|--------------|--------------|
|  |  4 005897 165579 | 05 7608 94 | silver grey / K x DK silver grey / D x DT 1/2" ; 80 cm | 1 |  | 16.87 | 18.17 |
| |  7 611038 250010 | 05 7615 98 | silver grey / K x DK silver grey / D x DT 1/2" ; 150 cm | 5 |  | 16.96 | 18.27 |
| |  7 611038 250027 | 05 7618 98 | silver grey / K x DK silver grey / D x DT 1/2" ; 180 cm | 5 |  | 17.99 | 19.37 |
| |  7 611038 250034 | 05 7620 98 | silver grey / K x DK silver grey / D x DT 1/2" ; 200 cm | 5 |  | 19.11 | 20.58 |

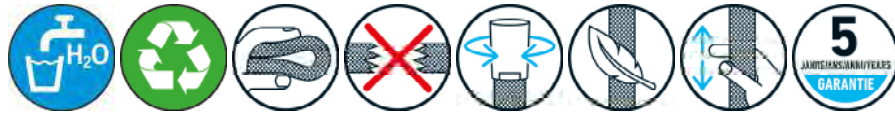



Einseitig mit Verdrehsicherung
 Un côté avec douille tournante
 EN1113

Duschsysteme Push

Systèmes de douche Push

| EAN-Nr. no EAN | Artikel Nr. no d'article | Beschreibung description | VPE ce | VE ue | UVP pro Stk. PVC CHF excl. | UVP pro Stk. PVC CHF incl. |
|-------------------|-----------------------------|-----------------------------|-----------|----------|----------------------------------|----------------------------------|
|-------------------|-----------------------------|-----------------------------|-----------|----------|----------------------------------|----------------------------------|

| Duschsystem Wakuda Push | | Système de douche Wakuda Push | | | | |
|---|--|-------------------------------|---|---|---|----------------------------|
|  |  7 611038 570514 | 08 3531 97 | schwarz matt noir mat 125 cm / 3 Strahl/Jets ; EK: C / 75 | 1 |  | 251.63 271.— |

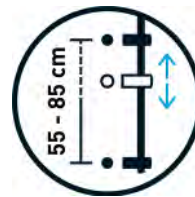
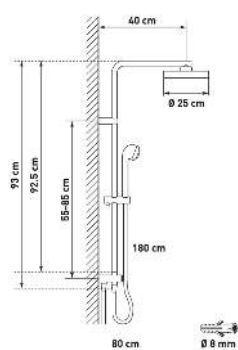

Montierbar auf bestehende Bohrlöcher für Duschen und Badewannen.

Bestehend aus:

- Kopfbrause (Ø 25cm)
- Duschbrause (3 Strahl)
- 2 Kunststoffbrauseschläuche CHROMALUX® Zero PVC-Frei (80 & 180cm)
- Wasserführende Duschgleitstange (Ø 25 mm)

Erfüllt



Trinkwasseranforderungen

Montage possible dans les trous existants des appareils précédents.

Composition:

- Pomme de douche (Ø 25cm)
- Poignée de douche (3 jets)
- 2 flexibles de douche plastique CHROMALUX® Zero sans PVC(80 & 180cm)
- Glissière de douche aquifère (Ø 25 mm)

Conforme aux exigences en matière d'eau potable

| Kopfbrause Wakuda | | Pomme de douche Wakuda | | | | |
|---|--|------------------------|--|---|---|---------------------------|
|  |  7 611038 570590 | 05 9423 97 | schwarz matt noir mat 1/2" / 1 Strahl/Jet ; EK: E / Ø 250 mm | 1 |  | 57.78 62.23 |

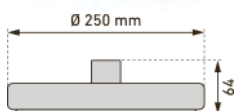

Erfüllt

Trinkwasseranforderungen

Conforme aux exigences en matière d'eau potable

Duschsysteme Push

Systèmes de douche Push

| EAN-Nr. no EAN | Artikel Nr. no d'article | Beschreibung description | VPE ce | VE ue | UVP pro Stk. PVC CHF excl. | UVP pro Stk. PVC CHF incl. |
|-------------------|-----------------------------|-----------------------------|-----------|----------|----------------------------------|----------------------------------|
|-------------------|-----------------------------|-----------------------------|-----------|----------|----------------------------------|----------------------------------|

Duschbrause Dike PCR Poignée douche Dike PCR



05 9832 98

schwarz matt
noir mat
1/2" / 3 Strahl/Jets ; EK: B / ~ 7
l/min

3



35.88

38.64

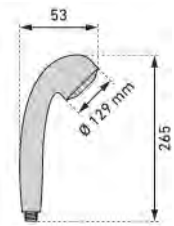

Brauseschl. CHROMALUX® Zero Flexible CHROMALUX® Zero



05 7408 94

schwarz / K x DK schwarz
noir / D x DT noir
1/2" ; 80 cm

1



13.23

14.25



05 7415 98

schwarz / K x DK, schwarz
noir / D x DT/ noir
1/2" ; 150 cm

5



16.96

18.27



05 7418 98

schwarz / K x DK / schwarz
noir / D x DT / noir
1/2" ; 180 cm

5



17.99

19.37



Einseitig mit Verdrehsicherung
Un côté avec douille tournante
EN1113

Gleiter zu Wakuda Push Support coulissant Wakuda Push



08 3530 96

schwarz matt
noir mat
Ø 24 mm

1



17.71

19.07

Duschsysteme Push

Systèmes de douche Push

| EAN-Nr. no EAN | Artikel Nr. no d'article | Beschreibung description | VPE ce | VE ue | UVP pro Stk. PVC CHF excl. | UVP pro Stk. PVC CHF incl. |
|-------------------|-----------------------------|-----------------------------|-----------|----------|----------------------------------|----------------------------------|
|-------------------|-----------------------------|-----------------------------|-----------|----------|----------------------------------|----------------------------------|

Umsteller zu Wakuda Push

Inverseur pour Wakuda Push



08 3530 94

schwarz matt
noir mat

1



58.71

63.23

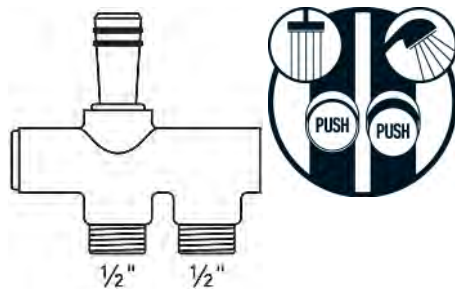

Wandbefestigung Wakuda Push

Fixation murale Wakuda Push



08 3530 95

schwarz matt
noir mat

1



29.36

31.62





Duschsysteme

Systèmes de douche

| EAN-Nr. no EAN | Artikel Nr. no d'article | Beschreibung description | VPE ce | VE ue | UVP pro Stk. PVC CHF excl. | UVP pro Stk. PVC CHF incl. |
|-------------------|-----------------------------|-----------------------------|-----------|----------|----------------------------------|----------------------------------|
|-------------------|-----------------------------|-----------------------------|-----------|----------|----------------------------------|----------------------------------|

Duschsystem Gerana LED Système de douche Gerana LED



| | | | | | | |
|--|-------------------|--|---|---|---------------|---------------|
|  7 611038 570361 | 08 3376 97 | verchromt chromé 133 cm / 3 Strahl/Jets ; EK: C / 60 | 1 |  | 193.85 | 208.77 |
|--|-------------------|--|---|---|---------------|---------------|

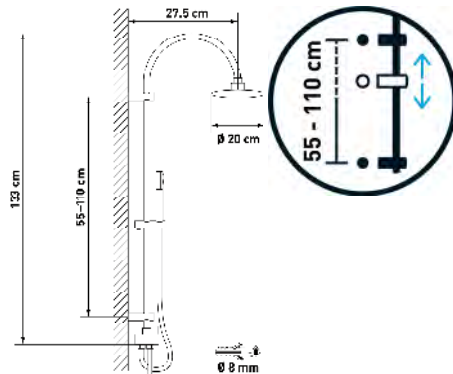

Montierbar auf bestehende Bohrlöcher für Duschen und Badewannen.

Bestehend aus:

- Kopfbrause (Ø 20cm)
- LED Duschbrause (3 Strahl)
- 2 Metallbrauseschläuche CHROMALUX® Zero PVC-Frei (80 & 180cm)
- Wasserführende Duschgleitstange (Ø 25 mm)

Erfüllt

Trinkwasseranforderungen

Montage possible dans les trous existants des appareils précédents.



Composition:

- Pomme de douche (Ø 20cm)
- Poignée de douche LED (3 jet)
- 2 flexibles de douche métallique CHROMALUX® Zero sans PVC (80 & 180cm)
- Glissière de douche aquifère (Ø 25 mm)

Conforme aux exigences en matière d'eau potable

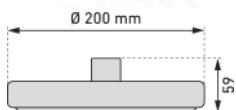
Kopfbrause Pandia Pomme de douche Pandia



| | | | | | | |
|--|-------------------|---|---|---|--------------|--------------|
|  7 611038 570576 | 05 9421 96 | verchromt chromé ½" / 1 Strahl/Jet ; Ø 200 mm | 1 |  | 28.89 | 31.12 |
|--|-------------------|---|---|---|--------------|--------------|



Erfüllt

Trinkwasseranforderungen

Conforme aux exigences en matière d'eau potable

Duschsysteme

Systèmes de douche

| EAN-Nr. <i>no EAN</i> | Artikel Nr. <i>no d'article</i> | Beschreibung <i>description</i> | VPE <i>ce</i> | VE <i>ue</i> | UVP pro Stk. <i>PVC</i> CHF excl. | UVP pro Stk. <i>PVC</i> CHF incl. |
|--------------------------|------------------------------------|------------------------------------|------------------|-----------------|---|---|
|--------------------------|------------------------------------|------------------------------------|------------------|-----------------|---|---|

Duschbrause Lich LED

Poignée de douche Lich LED



05 9819 98

verchromt
chromé
1/2" / 3 Strahl/Jets ; EK: C

3



36.81

39.65

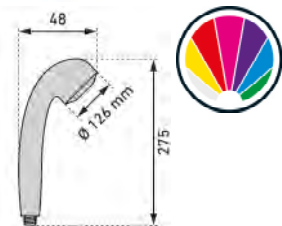
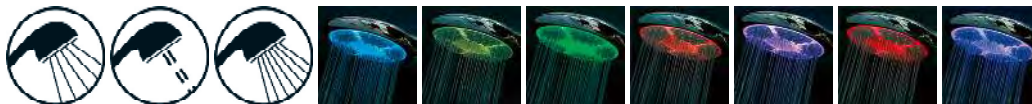



Erfüllt
Trinkwasseranforderungen
Conforme aux exigences en
matière d'eau potable

Duschsysteme

Systèmes de douche

| EAN-Nr. no EAN | Artikel Nr. no d'article | Beschreibung description | VPE ce | VE ue | UVP pro Stk. PVC CHF excl. | UVP pro Stk. PVC CHF incl. |
|-------------------|-----------------------------|-----------------------------|-----------|----------|----------------------------------|----------------------------------|
|-------------------|-----------------------------|-----------------------------|-----------|----------|----------------------------------|----------------------------------|

| Duschsystem Despina | | Système de douche Despina | | | | |
|---|-------------------|---|---|---|---------------|---------------|
|  | 08 3377 97 | verchromt chromé 133 cm / 1 Strahl/Jet ; EK: C / 61 | 1 |  | 193.85 | 208.77 |

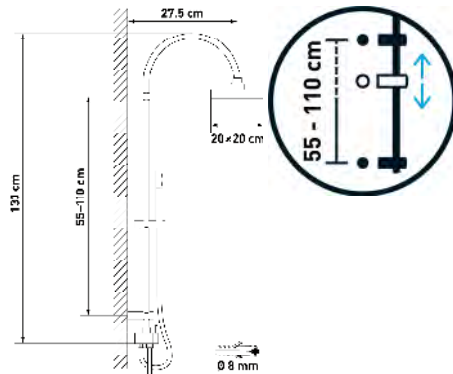

Montierbar auf bestehende Bohrlöcher für Duschen und Badewannen.

Bestehend aus:

- Kopfbrause (20 x 20cm)
- Duschbrause (1 Strahl)
- 2 Metallbrauseschläuche PVC-Frei (80 & 180cm)
- Wasserführende Duschgleitstange (Ø 25 mm)

Erfüllt



Trinkwasseranforderungen

Montage possible dans les trous existants des appareils précédents.

Composition:

- Pomme de douche (20 x 20cm)
- Poignée de douche (1 jet)
- 2 flexibles de douche métallique sans PVC (80 & 180cm)
- Glissière de douche aquifère (Ø 25 mm)

Conforme aux exigences en matière d'eau potable

| Kopfbrause Fenrir | | Pomme de douche Fenrir | | | | |
|---|-------------------|---|---|---|--------------|--------------|
|  | 05 9422 96 | verchromt chromé 1/2" / 1 Strahl/Jet ; 200 x 200 mm | 1 |  | 28.89 | 31.12 |

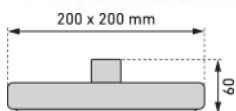



Duschsysteme

Systèmes de douche

| EAN-Nr. <i>no EAN</i> | Artikel Nr. <i>no d'article</i> | Beschreibung <i>description</i> | VPE <i>ce</i> | VE <i>ue</i> | UVP pro Stk. <i>PVC</i> CHF excl. | UVP pro Stk. <i>PVC</i> CHF incl. |
|--------------------------|------------------------------------|------------------------------------|------------------|-----------------|---|---|
|--------------------------|------------------------------------|------------------------------------|------------------|-----------------|---|---|

Duschbrause Wei PCR

Poignée douche Wei PCR

| | | | | | | | |
|---|--|-------------------|--|---|---|--------------|--------------|
|  |  7 611038 570149 | 05 9810 98 | verchromt <i>chromé</i> 1/2" / 1 Strahl/Jet ; EK: B / ~ 7 l/min | 3 |  | 16.50 | 17.77 |
| | | | | | | | |

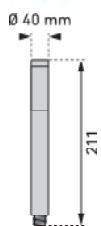



Erfüllt
 Trinkwasseranforderungen
*Conforme aux exigences en
 matière d'eau potable*

Duschsysteme

Systèmes de douche

| EAN-Nr. no EAN | Artikel Nr. no d'article | Beschreibung description | VPE ce | VE ue | UVP pro Stk. PVC CHF excl. | UVP pro Stk. PVC CHF incl. |
|-------------------|-----------------------------|-----------------------------|-----------|----------|----------------------------------|----------------------------------|
|-------------------|-----------------------------|-----------------------------|-----------|----------|----------------------------------|----------------------------------|

| Duschsystem Iason | | Système de douche Iason | | | | | |
|---|--|-------------------------|---|---|---|---------------|---------------|
|  |  7 611038 570385 | 08 3378 97 | verchromt chromé 125 cm / 1 Strahl/Jet ; EK: D / 62 | 1 |  | 174.28 | 187.69 |

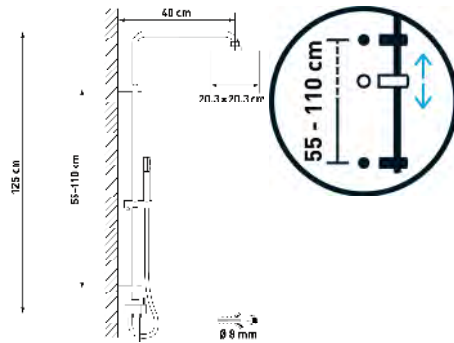

Montierbar auf bestehende Bohrlöcher für Duschen und Badewannen.

Bestehend aus:

- Kopfbrause (20.3 x 20.3cm)
- Duschbrause (1 Strahl)
- 2 Metallbrauseschläuche PVC-Frei (80 & 180cm)
- Wasserführende Duschgleitstange (Ø 25 mm)

Erfüllt



Trinkwasseranforderungen

Montage possible dans les trous existants des appareils précédents.

Composition:

- Pomme de douche (20.3 x 20.3cm)
- Poignée de douche (1 jet)
- 2 flexibles de douche métallique sans PVC (80 & 180cm)
- Glissière de douche aquifère (Ø 25 mm)

Conforme aux exigences en matière d'eau potable

| Kopfbrause Irbos | | Pomme de douche Irbos | | | | | |
|---|--|-----------------------|---|---|---|--------------|--------------|
|  |  7 611038 570569 | 05 9420 96 | verchromt chromé 1/2" / 1 Strahl/Jet ; 203 x 203 mm | 1 |  | 28.89 | 31.12 |

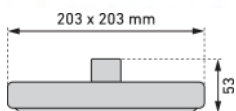

Duschsysteme

Systèmes de douche

| EAN-Nr. no EAN | Artikel Nr. no d'article | Beschreibung description | VPE ce | VE ue | UVP pro Stk. PVC CHF excl. | UVP pro Stk. PVC CHF incl. |
|-------------------|-----------------------------|-----------------------------|-----------|----------|----------------------------------|----------------------------------|
|-------------------|-----------------------------|-----------------------------|-----------|----------|----------------------------------|----------------------------------|

Duschbrause Aitne PCR

Poignée douche Aitne PCR



05 9809 98

verchromt
chromé
1/2" / 1 Strahl/Jet ; EK: C / ~ 10
l/min

3



14.54

15.66

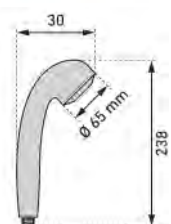



Erfüllt
Trinkwasseranforderungen
Conforme aux exigences en
matière d'eau potable

Duschsysteme

Systèmes de douche

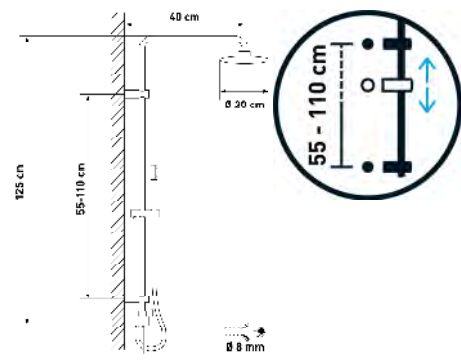

| EAN-Nr. no EAN | Artikel Nr. no d'article | Beschreibung description | VPE ce | VE ue | UVP pro Stk. PVC CHF excl. | UVP pro Stk. PVC CHF incl. |
|-------------------|-----------------------------|-----------------------------|-----------|----------|----------------------------------|----------------------------------|
|-------------------|-----------------------------|-----------------------------|-----------|----------|----------------------------------|----------------------------------|

| Duschsystem Namaka | | Système de douche Namaka | | | | |
|---|-------------------|---|---|---|---------------|---------------|
|  | 08 3379 97 | verchromt chromé 125 cm / 1 Strahl/Jet ; EK: C / 63 | 1 |  | 174.28 | 187.69 |



Montierbar auf bestehende Bohrlöcher für Duschen und Badewannen.
Bestehend aus:
- Kopfbrause (Ø 20cm)
- Duschbrause (1 Strahl)
- 2 Metallbrauseschläuche PVC-Frei (80 & 180cm)
- Wasserführende Duschgleitstange (Ø 25 mm)

Erfüllt Trinkwasseranforderungen
Montage possible dans les trous existants des appareils précédents.
Composition:
- Pomme de douche (Ø 20cm)
- Poignée de douche (1 jet)
- 2 flexibles de douche métallique sans PVC (80 & 180cm)
- Glissière de douche aquifère (Ø 25 mm)
Conforme aux exigences en matière d'eau potable

| Kopfbrause Pandia | | Pomme de douche Pandia | | | | |
|---|-------------------|---|---|---|--------------|--------------|
|  | 05 9421 96 | verchromt chromé 1/2" / 1 Strahl/Jet ; Ø 200 mm | 1 |  | 28.89 | 31.12 |

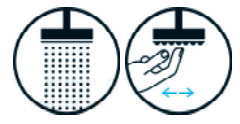
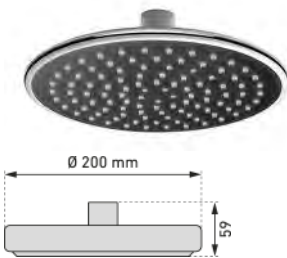

Erfüllt Trinkwasseranforderungen
Conforme aux exigences en matière d'eau potable

Duschsysteme

Systèmes de douche

| EAN-Nr. no EAN | Artikel Nr. no d'article | Beschreibung description | VPE ce | VE ue | UVP pro Stk. PVC CHF excl. | UVP pro Stk. PVC CHF incl. |
|-------------------|-----------------------------|-----------------------------|-----------|----------|----------------------------------|----------------------------------|
|-------------------|-----------------------------|-----------------------------|-----------|----------|----------------------------------|----------------------------------|

Duschbrause Monoton PCR

Poignée de douche Monoton PCR



05 9930 98

verchromt
chromé
1/2" / 1 Strahl/ Jet ; EK: C / ~ 10
l/min

3



16.87

18.17

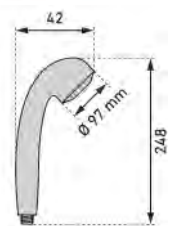



Erfüllt
Trinkwasseranforderungen
Conforme aux exigences en
matière d'eau potable

Duschsysteme

Systèmes de douche

| EAN-Nr. no EAN | Artikel Nr. no d'article | Beschreibung description | VPE ce | VE ue | UVP pro Stk. PVC CHF excl. | UVP pro Stk. PVC CHF incl. |
|-------------------|-----------------------------|-----------------------------|-----------|----------|----------------------------------|----------------------------------|
|-------------------|-----------------------------|-----------------------------|-----------|----------|----------------------------------|----------------------------------|

| Duschsystem Haimon | | Système de douche Haimon | | | | |
|---|-------------------|---|---|---|---------------|---------------|
|  | 08 3380 97 | verchromt chromé 112 cm / 1 Strahl/Jet ; EK: C / 64 | 1 |  | 174.28 | 187.69 |

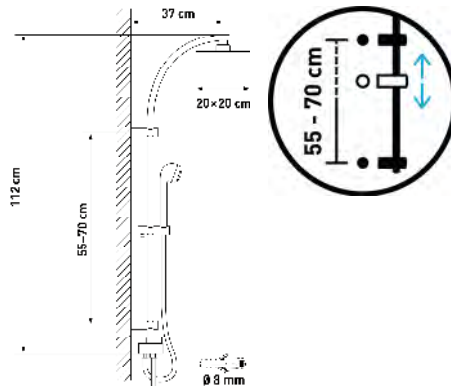

Montierbar auf bestehende Bohrlöcher für Duschen und Badewannen.

Bestehend aus:

- Kopfbrause (Ø 20cm)
- Duschbrause (1 Strahl)
- 2 Metallbrauseschläuche PVC-Frei (80 & 180cm)
- Wasserführende Duschgleitstange (Ø 25 mm)

Erfüllt



Trinkwasseranforderungen

Montage possible dans les trous existants des appareils précédents.

Composition:

- Pomme de douche (Ø 20cm)
- Poignée de douche (1 jet)
- 2 flexibles de douche métallique sans PVC (80 & 180cm)
- Glissière de douche aquifère (Ø 25 mm)

Conforme aux exigences en matière d'eau potable

| Kopfbrause Ruud | | Pomme de douche Ruud | | | | |
|---|-------------------|---|---|---|--------------|--------------|
|  | 05 9418 97 | verchromt chromé ½" / 1 Strahl/Jet ; EK: D / 200 x 200 mm | 1 |  | 38.68 | 41.65 |

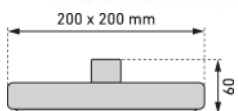

Erfüllt

Trinkwasseranforderungen

Conforme aux exigences en matière d'eau potable

Duschsysteme

Systèmes de douche

| EAN-Nr. <i>no EAN</i> | Artikel Nr. <i>no d'article</i> | Beschreibung <i>description</i> | VPE <i>ce</i> | VE <i>ue</i> | UVP pro Stk. <i>PVC</i> CHF excl. | UVP pro Stk. <i>PVC</i> CHF incl. |
|--------------------------|------------------------------------|------------------------------------|------------------|-----------------|---|---|
|--------------------------|------------------------------------|------------------------------------|------------------|-----------------|---|---|

Duschbrause Sabik One PCR

Poignée douche Sabik One PCR



05 9844 98

verchromt
chromé
1/2" / 1 Strahl/Jet ; EK: B

3



14.54

15.66

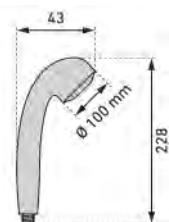

Erfüllt
Trinkwasseranforderungen
Conforme aux exigences en
matière d'eau potable



Duschsysteme

Systèmes de douche

| EAN-Nr. no EAN | Artikel Nr. no d'article | Beschreibung description | VPE ce | VE ue | UVP pro Stk. PVC CHF excl. | UVP pro Stk. PVC CHF incl. |
|-------------------|-----------------------------|-----------------------------|-----------|----------|----------------------------------|----------------------------------|
|-------------------|-----------------------------|-----------------------------|-----------|----------|----------------------------------|----------------------------------|

Duschsystem Irbos LED Système de douche Irbos LED



| | | | | | | |
|--|-------------------|--|---|---|---------------|---------------|
|  7 611038 570415 | 08 3381 97 | verchromt chromé 112 cm / 3 Strahl/Jets ; EK: C / 65 | 1 |  | 193.85 | 208.77 |
|--|-------------------|--|---|---|---------------|---------------|

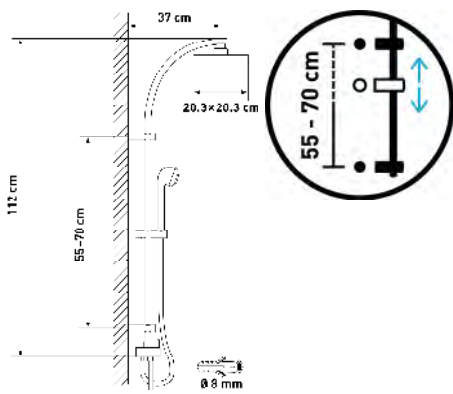



Montierbar auf bestehende Bohrlöcher für Duschen und Badewannen.
Bestehend aus:
- Kopfbrause (20.3 x 20.3cm)
- LED Duschbrause (3 Strahl)
- 2 Metallbrauseschläuche PVC-Frei (80 & 180cm)
- Wasserführende Duschgleitstange (Ø 25 mm)

Erfüllt Trinkwasseranforderungen
Montage possible dans les trous existants des appareils précédents.
Composition:
- Pomme de douche (20.3 x 20.3cm)
- Poignée de douche LED (3 jet)
- 2 flexibles de douche métallique sans PVC (80 & 180cm)
- Glissière de douche aquifère (Ø 25 mm)
Conforme aux exigences en matière d'eau potable

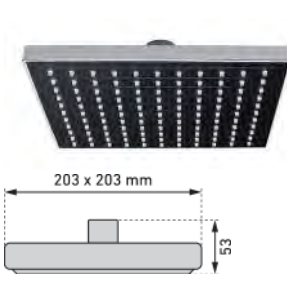
Kopfbrause Irbos Pomme de douche Irbos



| | | | | | | |
|--|-------------------|---|---|---|--------------|--------------|
|  7 611038 570569 | 05 9420 96 | verchromt chromé 1/2" / 1 Strahl/Jet ; 203 x 203 mm | 1 |  | 28.89 | 31.12 |
|--|-------------------|---|---|---|--------------|--------------|

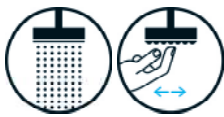



Duschsysteme

Systèmes de douche

| EAN-Nr. <i>no EAN</i> | Artikel Nr. <i>no d'article</i> | Beschreibung <i>description</i> | VPE <i>ce</i> | VE <i>ue</i> | UVP pro Stk. <i>PVC</i> CHF excl. | UVP pro Stk. <i>PVC</i> CHF incl. |
|--------------------------|------------------------------------|------------------------------------|------------------|-----------------|---|---|
|--------------------------|------------------------------------|------------------------------------|------------------|-----------------|---|---|

| | |
|-----------------------------|-----------------------------------|
| Duschbrause Keid LED | Poignée de douche Keid LED |
|-----------------------------|-----------------------------------|

| | | | | | | | |
|---|--|-------------------|--|---|--|--------------|--------------|
|  |  7 611038 570125 | 05 9813 98 | verchromt <i>chromé</i> 1/2" / 3 Strahl/Jets ; EK: C | 3 | <div style="border: 1px solid black; padding: 2px; display: inline-block;">1</div> | 48.46 | 52.19 |
|---|--|-------------------|--|---|--|--------------|--------------|

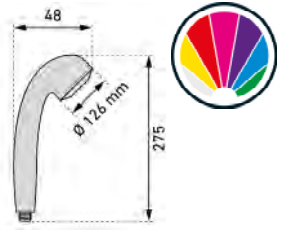



Temperaturanzeige auf LCD Display.
 Erfüllt Trinkwasseranforderungen
Affichage de la température sur écran LCD.
Conforme aux exigences en matière d'eau potable

Duschsysteme

Systèmes de douche

| EAN-Nr. no EAN | Artikel Nr. no d'article | Beschreibung description | VPE ce | VE ue | UVP pro Stk. PVC CHF excl. | UVP pro Stk. PVC CHF incl. |
|-------------------|-----------------------------|-----------------------------|-----------|----------|----------------------------------|----------------------------------|
|-------------------|-----------------------------|-----------------------------|-----------|----------|----------------------------------|----------------------------------|

| Duschsystem Proteus | | Système de douche Proteus | | | | |
|---|-------------------|--|---|---|---------------|---------------|
|  | 08 3382 97 | verchromt chromé 112 cm / 3 Strahl/Jets ; EK: C / 66 | 1 |  | 174.28 | 187.69 |

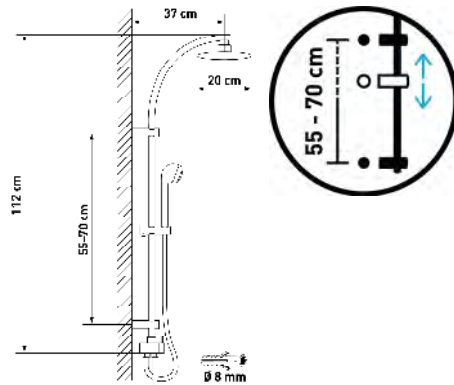

Montierbar auf bestehende Bohrlöcher für Duschen und Badewannen.

Bestehend aus:

- Kopfbrause (Ø 20cm)
- Duschbrause (3 Strahl)
- 2 Metallbrauseschläuche PVC-Frei (80 & 180cm)
- Wasserführende Duschgleitstange (Ø 25 mm)

Erfüllt



Trinkwasseranforderungen

Montage possible dans les trous existants des appareils précédents.

Composition:

- Pomme de douche (Ø 20cm)
- Poignée de douche (3 jet)
- 2 flexibles de douche métallique sans PVC (80 & 180cm)
- Glissière de douche aquifère (Ø 25 mm)

Conforme aux exigences en matière d'eau potable

| Kopfbrause Pandia | Pomme de douche Pandia | | | | | |
|---|------------------------|---|---|---|--------------|--------------|
|  | 05 9421 96 | verchromt chromé 1/2" / 1 Strahl/Jet ; Ø 200 mm | 1 |  | 28.89 | 31.12 |

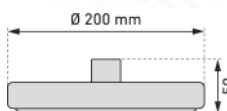

Erfüllt

Trinkwasseranforderungen

Conforme aux exigences en matière d'eau potable

Duschsysteme

Systèmes de douche

| EAN-Nr. no EAN | Artikel Nr. no d'article | Beschreibung description | VPE ce | VE ue | UVP pro Stk. PVC CHF excl. | UVP pro Stk. PVC CHF incl. |
|-------------------|-----------------------------|-----------------------------|-----------|----------|----------------------------------|----------------------------------|
|-------------------|-----------------------------|-----------------------------|-----------|----------|----------------------------------|----------------------------------|

Duschbrause Triton PCR

Poignée de douche Triton PCR



7 611038 179755

05 9931 98

verchromt
chromé
1/2" / 3 Strahl/Jets ; EK: C / 10
l/min

3



20.04

21.58

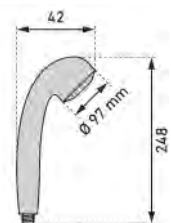



Erfüllt
Trinkwasseranforderungen
Conforme aux exigences en
matière d'eau potable

Duschsysteme

Systèmes de douche

| EAN-Nr. no EAN | Artikel Nr. no d'article | Beschreibung description | VPE ce | VE ue | UVP pro Stk. PVC CHF excl. | UVP pro Stk. PVC CHF incl. |
|-------------------|-----------------------------|-----------------------------|-----------|----------|----------------------------------|----------------------------------|
|-------------------|-----------------------------|-----------------------------|-----------|----------|----------------------------------|----------------------------------|

| Duschsystem Aites | | Système de douche Aites | | | | |
|---|--|-------------------------|--|---|---|-----------------------------|
|  |  7 611038 570439 | 08 3383 97 | verchromt chromé 115-140 cm / 1 Strahl/Jet ; EK: C / 67 | 1 |  | 154.70 166.62 |

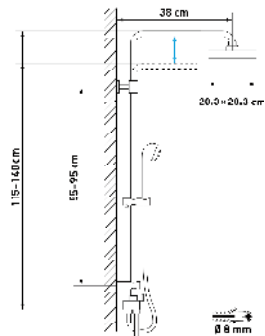

Montierbar auf bestehende Bohrlöcher für Duschen und Badewannen.

Bestehend aus:

- Kopfbrause (20.3 x 20.3cm)
- Duschbrause (1 Strahl)
- 2 Metallbrauseschläuche PVC-Frei (80 & 180cm)
- Wasserführende Duschgleitstange (Ø 25 mm)

Erfüllt



Trinkwasseranforderungen

Montage possible dans les trous existants des appareils précédents.

Composition:

- Pomme de douche (20.3 x 20.3cm)
- Poignée de douche (1 jet)
- 2 flexibles de douche métallique sans PVC (80 & 180cm)
- Glissière de douche aquifère (Ø 25 mm)

Conforme aux exigences en matière d'eau potable

| Kopfbrause Irbos | | Pomme de douche Irbos | | | | |
|---|--|-----------------------|---|---|---|---------------------------|
|  |  7 611038 570569 | 05 9420 96 | verchromt chromé 1/2" / 1 Strahl/Jet ; 203 x 203 mm | 1 |  | 28.89 31.12 |

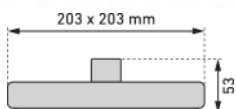



Duschsysteme

Systemes de douche

| EAN-Nr. <i>no EAN</i> | Artikel Nr. <i>no d'article</i> | Beschreibung <i>description</i> | VPE <i>ce</i> | VE <i>ue</i> | UVP pro Stk. <i>PVC</i> CHF excl. | UVP pro Stk. <i>PVC</i> CHF incl. |
|--------------------------|------------------------------------|------------------------------------|------------------|-----------------|---|---|
|--------------------------|------------------------------------|------------------------------------|------------------|-----------------|---|---|

Kopfbrause Irbos

Pomme de douche Irbos

| | | | | | | |
|---|------------------|----------------------------------|---|---|--|--|
|  | ST RPU CK | 1 Strahl <i>1 jet</i> 1/2" | 1 |  | | |
|---|------------------|----------------------------------|---|---|--|--|

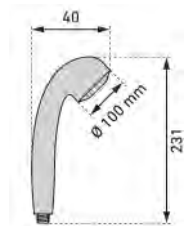



Erfüllt
Trinkwasseranforderungen
Conforme aux exigences en
matière d'eau potable

Duschsysteme

Systèmes de douche

| EAN-Nr. no EAN | Artikel Nr. no d'article | Beschreibung description | VPE ce | VE ue | UVP pro Stk. PVC CHF excl. | UVP pro Stk. PVC CHF incl. |
|-------------------|-----------------------------|-----------------------------|-----------|----------|----------------------------------|----------------------------------|
|-------------------|-----------------------------|-----------------------------|-----------|----------|----------------------------------|----------------------------------|

| Duschsystem Fenrir | | Système de douche Fenrir | | | | | |
|---|--|--------------------------|---|---|---|---------------|---------------|
|  |  7 611038 570446 | 08 3384 97 | verchromt <i>chromé</i> 115-140 cm / 1 Strahl/Jet ; EK: C / 68 | 1 |  | 154.70 | 166.62 |

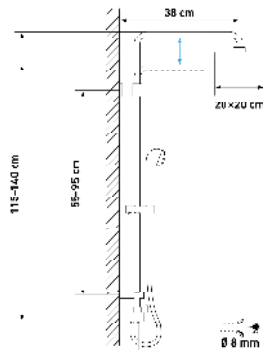

Montierbar auf bestehende Bohrlöcher für Duschen und Badewannen.

Bestehend aus:

- Kopfbrause (Ø 20cm)
- Duschbrause (1 Strahl)
- 2 Metallbrauseschläuche PVC-Frei (80 & 180cm)
- Wasserführende Duschgleitstange (Ø 25 mm)

Erfüllt



Trinkwasseranforderungen

Montage possible dans les trous existants des appareils précédents.

Composition:

- Pomme de douche (Ø 20cm)
- Poignée de douche (1 jet)
- 2 flexibles de douche métallique sans PVC (80 & 180cm)
- Glissière de douche aquifère (Ø 25 mm)

Conforme aux exigences en matière d'eau potable

| Kopfbrause Fenrir | | Pomme de douche Fenrir | | | | | |
|---|--|------------------------|--|---|---|--------------|--------------|
|  |  7 611038 570583 | 05 9422 96 | verchromt <i>chromé</i> 1/2" / 1 Strahl/Jet ; 200 x 200 mm | 1 |  | 28.89 | 31.12 |

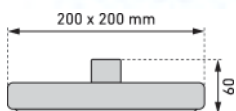

Duschsysteme

Systèmes de douche

| EAN-Nr. no EAN | Artikel Nr. no d'article | Beschreibung description | VPE ce | VE ue | UVP pro Stk. PVC CHF excl. | UVP pro Stk. PVC CHF incl. |
|-------------------|-----------------------------|-----------------------------|-----------|----------|----------------------------------|----------------------------------|
|-------------------|-----------------------------|-----------------------------|-----------|----------|----------------------------------|----------------------------------|

Duschbrause Ate PCR

Poignée de douche Ate PCR



05 9828 98

verchromt
chromé
1/2" / 1 Strahl/Jet ; EK: A / ~ 5
l/min

3



11.65

12.55

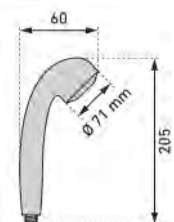

Erfüllt
Trinkwasseranforderungen
Conforme aux exigences en
matière d'eau potable

Gleiter zu Duschsystemen

Supp. coulissant syst. douche



08 3312 01

ABS verchromt
ABS chromé
Ø 25 mm

1



14.07

15.16

Umsteller zu Duschsystemen

Inverseur pour systèmes douche



08 3360 01

verchromt
chromé

1



48.46

52.19

Konsole zu Duschsystemen

Fix. murale p/systèmes douche



08 3360 10

Aluminium verchromt
aluminium chromé
Ø 25 mm

1



21.90

23.59



Duschsysteme

Systemes de douche









| EAN-Nr. no EAN | Artikel Nr. no d'article | Beschreibung description | VPE ce | VE ue | UVP pro Stk. PVC CHF excl. | UVP pro Stk. PVC CHF incl. |
|-------------------|-----------------------------|-----------------------------|-----------|----------|----------------------------------|----------------------------------|
|-------------------|-----------------------------|-----------------------------|-----------|----------|----------------------------------|----------------------------------|

Metallbrauseschlauch Fortaflex Flexible en métal Fortaflex



Metallbrauseschlauch mit PVC-freiem Innenschlauch. Hochwertig und hygienisch unbedenklich. Einseitig mit Verdrehsicherung.

Erfüllt Trinkwasseranforderungen
Flexible de douche en métal avec tube intérieur sans PVC. De grande qualité et irréprochable sur le plan de l'hygiène. Un côté avec douille tournante
Conforme aux exigences en matière d'eau potable
EN1113

| | | | | | | |
|---|-------------------|--|---|---|--------------|--------------|
|  | 05 2208 94 | verchromt / K x DK / PVC-frei chromé / D x DT / sans PVC 1/2" ; 80 cm | 1 |  | 10.81 | 11.64 |
|  | 05 2215 98 | verchromt / K x DK / PVC-frei chromé / D x DT / sans PVC 1/2" ; 150CM | 5 |  | 14.82 | 15.96 |
|  | 05 2215 98 | verchromt / K x DK / PVC-frei chromé / D x DT / sans PVC 1/2" ; 150CM | 5 |  | 14.82 | 15.96 |
|  | 05 2220 98 | verchromt / K x DK / PVC-frei chromé / D x DT / sans PVC 1/2" ; 200 cm | 5 |  | 18.64 | 20.07 |

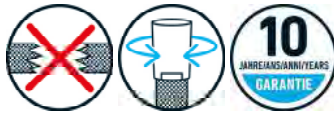

Brauseschl. CHROMALUX® Zero Flexible CHROMALUX® Zero



Einseitig mit Verdrehsicherung
Un côté avec douille tournante
EN1113

| | | | | | | |
|---|-------------------|---|---|---|--------------|--------------|
|  | 05 7608 94 | silver grey / K x DK silver grey / D x DT 1/2" ; 80 cm | 1 |  | 16.87 | 18.17 |
|  | 05 7615 98 | silver grey / K x DK silver grey / D x DT 1/2" ; 150 cm | 5 |  | 16.96 | 18.27 |
|  | 05 7618 98 | silver grey / K x DK silver grey / D x DT 1/2" ; 180 cm | 5 |  | 17.99 | 19.37 |
|  | 05 7620 98 | silver grey / K x DK silver grey / D x DT 1/2" ; 200 cm | 5 |  | 19.11 | 20.58 |



Duschpaneele

Panneaux de douche

| EAN-Nr. no EAN | Artikel Nr. no d'article | Beschreibung description | VPE ce | VE ue | UVP pro Stk. PVC CHF excl. | UVP pro Stk. PVC CHF incl. |
|-------------------|-----------------------------|-----------------------------|-----------|----------|----------------------------------|----------------------------------|
|-------------------|-----------------------------|-----------------------------|-----------|----------|----------------------------------|----------------------------------|

NEW

Duschpaneel Palea

Colonne de douche Palea



08 3358 41

Aluminium verchromt
aluminium chromé
116 cm / 2 Strahl/Jet ; EK: G

1



213.42

229.85



08 3358 80

Aluminium schwarz
aluminium noir
116 cm / 2 Strahl/Jet ; EK: G

1



232.06

249.92

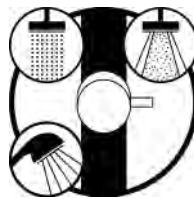
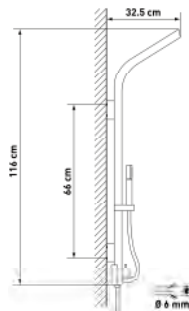

- Bestehend aus:
- Kopfbrause (2 Strahl, schwenkbar)
 - Duschbrause (1 Strahl)
 - 2 Kunststoffbrauseschläuche CHROMALUX® Zero PVC-Frei (80 & 180cm)

Erfüllt
Trinkwasseranforderungen
Composition:

- Pomme de douche (2 jets, orientable)
- Poignée de douche (1 jet)
- 2 flexibles de douche plastique CHROMALUX® Zero sans PVC(80 & 180cm)

Conforme aux exigences en matière d'eau potable

Duschbrause Sabik One PCR

Poignée douche Sabik One PCR



05 9844 98

verchromt
chromé
1/2" / 1 Strahl/Jet ; EK: B

3



14.54

15.66



05 9845 98

schwarz matt
noir mat
1/2" / 1 Strahl/Jet ; EK: B

3



17.43

18.77

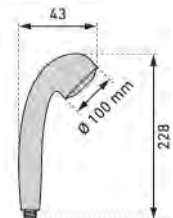











Erfüllt
Trinkwasseranforderungen
Conforme aux exigences en matière d'eau potable

Duschpaneele

Panneaux de douche

| EAN-Nr. <i>no EAN</i> | Artikel Nr. <i>no d'article</i> | Beschreibung <i>description</i> | VPE <i>ce</i> | VE <i>ue</i> | UVP pro Stk. <i>PVC</i> CHF excl. | UVP pro Stk. <i>PVC</i> CHF incl. |
|--------------------------|------------------------------------|------------------------------------|------------------|-----------------|---|---|
|--------------------------|------------------------------------|------------------------------------|------------------|-----------------|---|---|

| Brauseschl. CHROMALUX® Zero | | Flexible CHROMALUX® Zero | | | | | |
|--|--|--------------------------|--|---|---|--------------|--------------|
|   |  4 005897 165579 | 05 7608 94 | silver grey / K x DK <i>silver grey / D x DT</i> 1/2" ; 80 cm | 1 |  | 16.87 | 18.17 |
| |  7 611038 570620 | 05 7408 94 | schwarz / K x DK schwarz <i>noir / D x DT noir</i> 1/2" ; 80 cm | 1 |  | 13.23 | 14.25 |
| |  7 611038 250027 | 05 7618 98 | silver grey / K x DK <i>silver grey / D x DT</i> 1/2" ; 180 cm | 5 |  | 17.99 | 19.37 |
| |  7 611038 692414 | 05 7418 98 | schwarz / K x DK / schwarz <i>noir / D x DT / noir</i> 1/2" ; 180 cm | 5 |  | 17.99 | 19.37 |

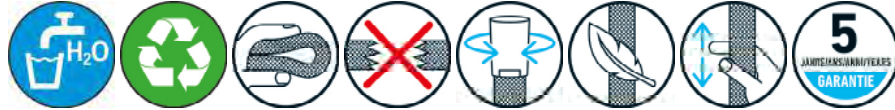

Einseitig mit Verdrehsicherung
Un côté avec douille tournante
 EN1113



Gartenduschen

Douches de jardin

| EAN-Nr. no EAN | Artikel Nr. no d'article | Beschreibung description | VPE ce | VE ue | UVP pro Stk. PVC CHF excl. | UVP pro Stk. PVC CHF incl. |
|-------------------|-----------------------------|-----------------------------|-----------|----------|----------------------------------|----------------------------------|
|-------------------|-----------------------------|-----------------------------|-----------|----------|----------------------------------|----------------------------------|

| Gartendusche Simple | | Douche à jardin Simple | | | | | |
|---|--|------------------------|-------------------------------------|---|---|--------|--------|
|  |  7 611038 188290 | 14 0110 97 | Edelstahl inox 210 cm / 38 cm | 1 |  | 197.57 | 212.79 |

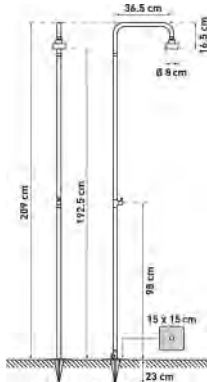

Mobile Gartendusche aus rostfrei gebürstetem Stahl, für die freie Positionierung auf dem Rasen, praktischer Steckdorn zum direkten Einstecken. 1/2" Anschlussgewinde für den Anschluss an den Gartenschlauch. Inkl. Kopfbrause Ø 80 mm und Umstellventil. Alles vorgefertigt für eine einfache Montage.

Douche de jardin mobile en acier inoxydable brossé, pour un positionnement libre sur la pelouse, broche pratique pour une insertion directe. Filetage de raccordement 1/2" pour le raccordement au tuyau d'arrosage. Comprend une douche de tête Ø 80 mm et une vanne de dérivation. Tout est préfabriqué pour une installation facile.



Wasser sparen in der Dusche Économiser l'eau dans la douche

Funktionsprinzip Mengenregler

Principe du régulateur de débit

Sobald Wasser durch den Mengenregler fließt, verformt sich der integrierte Präzisions-O-Ring und wird zwischen die Zacken des Regelsterns gedrückt. Dadurch verkleinern sich die Durchtrittsöffnungen für das Wasser. Je höher der Fließdruck, desto stärker verformt sich der Ring und die Durchtrittsöffnungen werden kleiner.

Dès que l'eau s'écoule à travers le régulateur de débit, le joint torique de précision intégré se déforme et est pressé entre les dents de l'étoile de régulation. Les ouvertures de passage de l'eau se réduisent ainsi. Plus la pression d'écoulement est élevée, plus l'anneau se déforme et plus les ouvertures de passage sont petites.

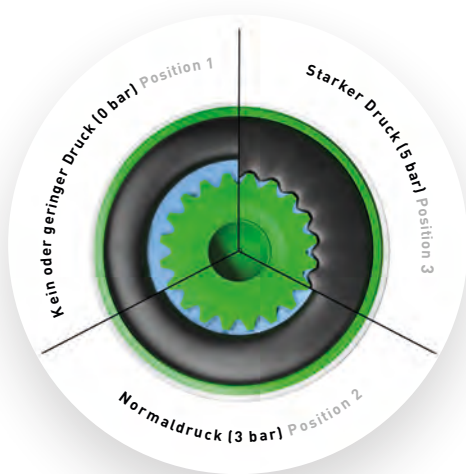

Montage Mengenregler PCW-01

Montage du régulateur de débit PCW-01

Dichtung aus dem Schlauch entfernen. Regler einsetzen und Schlauch sorgfältig in die Armatur einschrauben. Wenn kein Mengenregler eingesetzt wird, dann Schlauch mit Dichtung montieren.

Retirer le joint du tuyau. Insérer le régulateur et visser soigneusement le tuyau dans le robinet. Si aucun régulateur de débit n'est utilisé, monter le tuyau avec le joint.

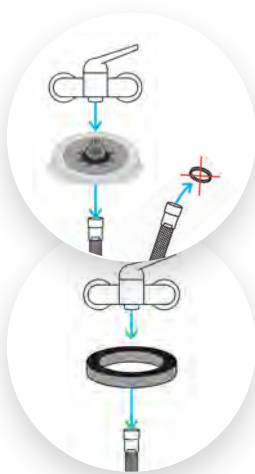

Montage Mengenregler PCW-02

Montage du régulateur de débit PCW-02

Duschbrause mit dem Regler sorgfältig in den Brauseschlauch einschrauben (nicht verkanten). Wenn Mengenregler eingesetzt, Dichtung im Brauseschlauch entfernen. Wenn Mengenregler nicht eingesetzt, Dichtung belassen.

Visser soigneusement le pommeau de douche avec le régulateur dans le flexible de douche (ne pas l'incliner). Si le régulateur de débit n'est pas installé, laisser le joint en place.

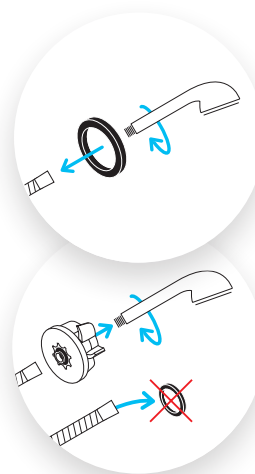

My Water Flow Control

My Water Flow Control

Dank der digitalen Anzeige kann der Wasserverbrauch sowie die -temperatur in Echtzeit abgelesen werden. Verschärft das Bewusstsein für den Wasser- und Energieverbrauch im Haushalt. Der My Water Flow Control funktioniert ohne Batterien, da dieser mit Hilfe eines eingebauten Stromgenerators läuft.

Grâce à l'affichage numérique, la consommation d'eau ainsi que la température peuvent être lues en temps réel. Sensibilise à la consommation d'eau et d'énergie dans le ménage.

Le My Water Flow Control fonctionne sans piles, car il est alimenté par un générateur d'électricité intégré.



Informationen zu PCW-01

Informations sur PCW-01

Folgenden QR-Code scannen, um mehr Informationen vom Mengenregler PCW-01 zu erhalten.

Scanner le code QR suivant pour obtenir plus d'informations sur le régulateur de débit PCW-01.



Informationen zu PCW-02

Informations sur PCW-02



Folgenden QR-Code scannen, um mehr Informationen vom Mengenregler PCW-02 zu erhalten.

Scanner le code QR suivant pour obtenir plus d'informations sur le régulateur de débit PCW-02.



My Water Flow Control

| EAN-Nr. no EAN | Artikel Nr. no d'article | Beschreibung description | VPE ce | VE ue | UVP pro Stk. PVC CHF excl. | UVP pro Stk. PVC CHF incl. |
|-------------------|-----------------------------|-----------------------------|-----------|----------|----------------------------------|----------------------------------|
|-------------------|-----------------------------|-----------------------------|-----------|----------|----------------------------------|----------------------------------|





























| My Water Flow Control Dusche | | My Water Flow Control p.douche | | | | | |
|---|--|--------------------------------|---|---|---|--------------|--------------|
|  |  7 611038 508913 | 70 6150 98 | verchromt <i>chromé</i> IG/F 1/2" x AG/M 1/2" ; ~ 8.9 l/min DE, GB, FR, IT, NL, ES, PT, TR, GR | 5 |  | 41.94 | 45.17 |
| | | | | | | | |



- Mit digitaler Anzeige der Wasserverbrauchsmenge und der Wassertemperatur in Echtzeit
- Funktioniert mittels eingebautem Stromgenerator, ohne Batterien
- Für Duscharmaturen mit 1/2" Anschlussgewinde
- Anzeigegerät an der Duscharmatur 360° frei drehbar
- Wasser sparend (~ 8.9 l/min bei 3 bar)
- Nicht geeignet für drucklose Geräte
- Avec affichage numérique de la consommation d'eau et de la température de l'eau en temps réel
- Alimenté par un générateur électrique intégré, fonctionne sans pile
- Pour robinetteries de douche à filetage de raccordement 1/2"
- L'afficheur sur la robinetterie de douche tourne à 360°
- Économise de l'eau (~ 8.9 l/min a 3 bar)
- Ne convient pas aux appareils à écoulement libre











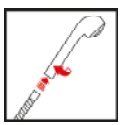





Mengenregler

Régulateurs de débit

| | EAN-Nr. no EAN | Artikel Nr. no d'article | Beschreibung description | VPE ce | VE ue | UVP pro Stk. PVC CHF excl. | UVP pro Stk. PVC CHF incl. |
|--|---|-----------------------------|--|-----------|---|----------------------------------|----------------------------------|
| PCR Mengenregler für Duschen | | | | | | | |
| PCR Limiteur d'eau p. douches | | | | | | | |
|  |  | 02 6294 94 | verchromt/gelb <i>chromé/jaune</i> 1/2" x 1/2" ; ~ 5 l/min | 1 |  | 13.42 | 14.45 |
| |  | 02 6296 94 | verchromt/schwarz <i>chromé/noir</i> 1/2" x 1/2" ; ~ 6 l/min | 1 |  | 13.42 | 14.45 |
| |  | 02 6298 94 | verchromt/weiss <i>chromé/blanc</i> 1/2" x 1/2" ; ~ 8 l/min | 1 |  | 13.42 | 14.45 |
| |  | 02 6300 94 | verchromt/blau <i>chromé/bleu</i> 1/2" x 1/2" ; ~ 10 l/min | 1 |  | 13.42 | 14.45 |
| |  | 02 6350 94 | verchromt/rot <i>chromé/rouge</i> 1/2" x 1/2" ; ~ 12 l/min | 1 |  | 13.42 | 14.45 |
| Durchflussmengenregler PCW-01 | | | | | | | |
| Limiteur de débit PCW-01 | | | | | | | |
|  |  | 58 8635 12 | gelb <i>jaune</i> Ø 18.7 mm ; ~ 5 l/min | 1 |  | 2.84 | 3.06 |
| |  | 58 8636 12 | schwarz <i>noir</i> Ø 18.7 mm ; ~ 6 l/min | 1 |  | 2.84 | 3.06 |
| |  | 58 8637 12 | grün <i>vert</i> Ø 18.7 mm ; ~ 7 l/min | 1 |  | 2.84 | 3.06 |
| |  | 58 8638 12 | weiss <i>blanc</i> Ø 18.7 mm ; ~ 8 l/min | 1 |  | 2.84 | 3.06 |
| |  | 58 8639 12 | orange Ø 18.7 mm ; ~ 9 l/min | 1 |  | 2.84 | 3.06 |
| |  | 58 8640 12 | hellblau <i>bleu clair</i> Ø 18.7 mm ; ~ 10 l/min | 1 |  | 2.84 | 3.06 |
| |  | 58 8641 12 | braun <i>brun</i> Ø 18.7 mm ; ~ 11 l/min | 1 |  | 2.84 | 3.06 |
| |  | 58 8642 12 | rot <i>rouge</i> Ø 18.7 mm ; ~ 12 l/min | 1 |  | 2.84 | 3.06 |

Mengenregler

Régulateurs de débit

| | EAN-Nr. no EAN | Artikel Nr. no d'article | Beschreibung description | VPE ce | VE ue | UVP pro Stk. PVC CHF excl. | UVP pro Stk. PVC CHF incl. |
|--|---|---------------------------------|---|-----------|---|----------------------------------|----------------------------------|
| Durchflussmengenregler PCW-02 | | Limiteur de débit PCW-02 | | | | | |
|   |  | 58 9087 10 | gelb <i>jaune</i> 1/2" ; ~ 5 l/min | 1 |  | 3.45 | 3.71 |
| |  | 70 5029 98 | gelb/2 Stück <i>jaune/2 pièces</i> 1/2" ; EK: A / ~ 5 l/min | 5 |  | 6.06 | 6.52 |
| |  | 58 9089 10 | grün <i>vert</i> 1/2" ; ~ 7 l/min | 1 |  | 3.45 | 3.71 |
| |  | 58 9090 10 | weiss <i>blanc</i> 1/2" ; ~ 8 l/min | 1 |  | 3.45 | 3.71 |
| |  | 58 9091 10 | orange 1/2" ; ~ 9 l/min | 1 |  | 3.45 | 3.71 |
| |  | 58 9092 10 | hellblau <i>bleu clair</i> 1/2" ; ~ 10 l/min | 1 |  | 3.45 | 3.71 |
| |  | 70 5031 98 | hellblau/2 Stück <i>bleu clair/2 pièces</i> 1/2" ; EK: C / ~ 10 l/min | 5 |  | 6.06 | 6.52 |
| |  | 58 9094 10 | rot <i>rouge</i> 1/2" ; ~ 12 l/min | 1 |  | 3.45 | 3.71 |





Mengenregler

Régulateurs de débit

| EAN-Nr. no EAN | Artikel Nr. no d'article | Beschreibung description | VPE ce | VE ue | UVP pro Stk. PVC CHF excl. | UVP pro Stk. PVC CHF incl. |
|-------------------|-----------------------------|-----------------------------|-----------|----------|----------------------------------|----------------------------------|
|-------------------|-----------------------------|-----------------------------|-----------|----------|----------------------------------|----------------------------------|

Wassersparer für Duschbrause

Économ. d'eau pour douchette

| | | | | | | | |
|---|--|-------------------|--|---|---|--------------|--------------|
|  |  7 611038 245207 | 05 9586 98 | gelb/grün/hellblau/3 Stück jaune/vert/bleu cl./3 pièces 1/2" ; ~ 5, ~ 7 & ~ 10 l/min | 5 |  | 8.39 | 9.03 |
| |  7 611038 098735 | 70 5140 98 | gelb/grün/hellblau/3 Stück jaune/vert/bleu claire/3 pièce 1/2" ; ~ 5, ~ 7 & ~ 10 l/min | 6 |  | 10.90 | 11.74 |

5 l/min

7 l/min

10 l/min

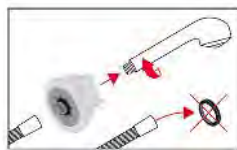

Wassersparer für Brausegriffe mit integrierter Dichtung. Passt in jeden Brausegriff.
Économiseur d'eau avec joint intégré. Adaptable dans toutes les poignées de douche.



Brausegriff mit dem Regler sorgfältig in den Brauseschlauch einschrauben (nicht verkanten).
Falls vorhanden, Dichtung im Brauseschlauch entfernen.
Viser avec précaution la poignée de douche avec le régulateur dans le flexible de douche (sans coincer).
S'il y a un joint dans le flexible de douche, veuillez le retirer.



SHOWER

| EAN-Nr. <i>no EAN</i> | Artikel Nr. <i>no d'article</i> | Beschreibung <i>description</i> | VPE <i>ce</i> | VE <i>ue</i> | UVP pro Stk. <i>PVC</i> CHF excl. | UVP pro Stk. <i>PVC</i> CHF incl. |
|--------------------------|------------------------------------|------------------------------------|------------------|-----------------|---|---|
|--------------------------|------------------------------------|------------------------------------|------------------|-----------------|---|---|

| Duschthermometer | | Thermomètre de douche | | | | | |
|---|--|-----------------------|-----------------------|---|---|-------|-------|
|  |  7 611038 161125 | 06 6441 98 | weiss <i>blanc</i> | 1 |  | 17.80 | 19.17 |

- Temperaturkontrolle beim Duschen
- Passt an alle handelsüblichen Brausen mit 1/2" Anschluss
- Temperaturbereich: 0 - 69°C
- Batterien: 2 x LR 44
- Wasserdicht
- LED-Alarmfunktion ab 41°C
- Auto-off Funktion

- Contrôle de la température pendant la douche
- S'adapte sur toutes les pommes de douche disponibles à l'aide d'un raccord 1/2"
- Plage de température: 0 à 69°C
- Piles: 2 x LR 44
- Étanche
- Fonction d'alarme LED à partir de 41°C
- Fonction d'arrêt automatique

| Badethermometer | | Thermomètre de bain | | | | | |
|---|--|---------------------|-----------------------|---|---|-------|-------|
|  |  7 611038 161118 | 06 6440 98 | Ente <i>canard</i> | 1 |  | 16.78 | 18.07 |

- Temperaturbereich: 0 - 50°C
- Batterien: 1 x CR2032
- Batterielaufzeit ca. ein Jahr
- Wasserdicht
- LED-Alarmfunktion ab 39°C
- Auto-off Funktion

- Plage de température: 0 à 50°C
- Pile: 1 x CR2032
- Durée de vie de la pile: env. un an
- Étanche
- Fonction d'alarme LED à partir de 39°C
- Fonction d'arrêt automatique

SHOWER

| EAN-Nr. no EAN | Artikel Nr. no d'article | Beschreibung description | VPE ce | VE ue | UVP pro Stk. PVC CHF excl. | UVP pro Stk. PVC CHF incl. |
|-------------------|-----------------------------|-----------------------------|-----------|----------|----------------------------------|----------------------------------|
|-------------------|-----------------------------|-----------------------------|-----------|----------|----------------------------------|----------------------------------|

Brauseschlauch Entleerventil

Vanne de vidange pour tuyau



05 9580 96

verchromt
chromé
1/2"

1



35.41

38.14

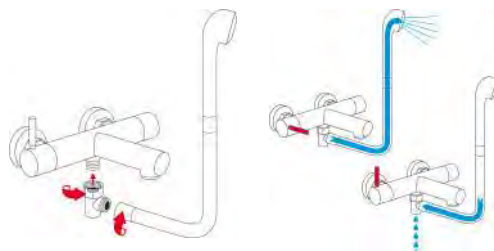

Zur Montage zwischen Schlauch und Armatur zur vollständigen Entleerung des Brauseschlauches.

Pour le montage entre le tuyau et la robinetterie pour la vidange complète du tuyau de douche.

Drehgelenk für Brauseschläuche

Articulation pour flexible



35 9001 90

verchromt
chromé
1/2"

1



15.10

16.26

Brausewinkel

Coude en poignée de douche



05 9588 98

verchromt
chromé
1/2" x 1/2" ; 45°

5



19.11

20.58



Druckbegrenzer für Dusche

Limiteur de pression douche



05 9595 96

verchromt
chromé
1/2" ; 1 BAR

1



11.65

12.55

Begrenzt den Leitungsdruck auf







1 bar





Limite la pression de la ligne à 1 bar

SHOWER

| EAN-Nr. no EAN | Artikel Nr. no d'article | Beschreibung description | VPE ce | VE ue | UVP pro Stk. PVC CHF excl. | UVP pro Stk. PVC CHF incl. |
|-------------------|-----------------------------|-----------------------------|-----------|----------|----------------------------------|----------------------------------|
|-------------------|-----------------------------|-----------------------------|-----------|----------|----------------------------------|----------------------------------|

| Brausehalter für Armatur | | Support douche pour robinet | | | | | |
|---|--|-----------------------------|-----------------------------|---|---|--------------|--------------|
|  |  7 611038 177676 | 05 9579 98 | verchromt chromé 1/2" | 3 |  | 11.09 | 11.94 |
| |  | | | | | | |

| Brausehalter Duschfix® | | Support de douche Duschfix® | | | | | |
|---|---|-----------------------------|---------------------|---|--|--------------|--------------|
|  |  7 611038 243982 | 05 9598 98 | verchromt chromé | 3 |  | 33.08 | 35.63 |
| |  7 611038 243975 | 05 9599 98 | weiss blanc | 5 |  | 22.37 | 24.09 |
|   | | | | | | | |

| Brausehalter clever | | Support de douche clever | | | | | |
|---|--|--------------------------|--------------------------|---|---|--------------|--------------|
|  |  7 611038 570545 | 05 9600 98 | schwarz matt noir mat | 3 |  | 14.54 | 15.66 |
| |  7 611038 570552 | 05 9601 98 | verchromt chromé | 3 |  | 14.54 | 15.66 |
|  |  | | | | | | |

SHOWER

| | EAN-Nr. <i>no EAN</i> | Artikel Nr. <i>no d'article</i> | Beschreibung <i>description</i> | VPE <i>ce</i> | VE <i>ue</i> | UVP pro Stk. <i>PVC</i> CHF excl. | UVP pro Stk. <i>PVC</i> CHF incl. |
|--|--------------------------|------------------------------------|------------------------------------|------------------|-----------------|---|---|
|--|--------------------------|------------------------------------|------------------------------------|------------------|-----------------|---|---|

Gelenkhalter verdeckte Montage

Support à rotule montage caché





| | | | | | | |
|--|-------------------|-----------------------|---|---|--------------|--------------|
|  7 611038 243883 | 05 9594 98 | weiss <i>blanc</i> | 5 |  | 19.11 | 20.58 |
|--|-------------------|-----------------------|---|---|--------------|--------------|

Gelenkhalter

Support à rotule





| | | | | | | |
|--|-------------------|---|---|---|--------------|--------------|
|  4 005897 618709 | 08 5000 97 | Messing verchromt <i>laiton chromé</i> | 1 |  | 54.99 | 59.22 |
|--|-------------------|---|---|---|--------------|--------------|

Gelenkhalter verdeckte Montage

Support à rotule montage caché





| | | | | | | |
|--|-------------------|---|---|---|--------------|--------------|
|  7 611038 243838 | 05 9592 98 | Messing verchromt <i>laiton chromé</i> | 5 |  | 43.80 | 47.17 |
|--|-------------------|---|---|---|--------------|--------------|



Gelenkhalter verdeckte Montage

Support à rotule montage caché



| | | | | | | |
|--|-------------------|----------------------------|---|---|--------------|--------------|
|  7 611038 243951 | 05 9591 98 | verchromt <i>chromé</i> | 3 |  | 15.84 | 17.06 |
|--|-------------------|----------------------------|---|---|--------------|--------------|

SHOWER

| | EAN-Nr. <i>no EAN</i> | Artikel Nr. <i>no d'article</i> | Beschreibung <i>description</i> | VPE <i>ce</i> | VE <i>ue</i> | UVP pro Stk. <i>PVC</i> CHF excl. | UVP pro Stk. <i>PVC</i> CHF incl. |
|---|--|------------------------------------|------------------------------------|------------------|---|---|---|
| Wandhalter konisch | | Support murale conique | | | | | |
|  |  7 611038 243944 | 05 9582 98 | ABS verchromt <i>ABS chromé</i> | 3 |  | 6.94 | 7.48 |





Küche und Waschküche

*Cuisine et
buanderie*

Kapitel 7 - Inhaltsverzeichnis

Chapitre 7 - Sommaire

| | |
|--|------|
| Küchenbrausen <i>Douchettes de cuisine</i> | 7.6 |
| Küchenschläuche <i>Flexibles de cuisine</i> | 7.13 |
| Industrieküchenbrause, Gastroschlauch <i>Douche de cuisine industrielle, tuyau gastro</i> | 7.17 |
| Küchenaccessoires <i>Accessoires de cuisine</i> | 7.19 |
| Abflusssiebe <i>Grilles pour évier</i> | 7.23 |
| Abfallsysteme <i>Collecteur de déchets</i> | 7.30 |
| Trinkwasserfilter <i>Filtres pour l'eau potable</i> | 7.34 |

Welcher Anschluss ist der Passende?

Quel raccord utiliser?

KWC Anschlüsse

Raccords KWC



KWC Anschluss ALT
Raccord KWC VIEUX

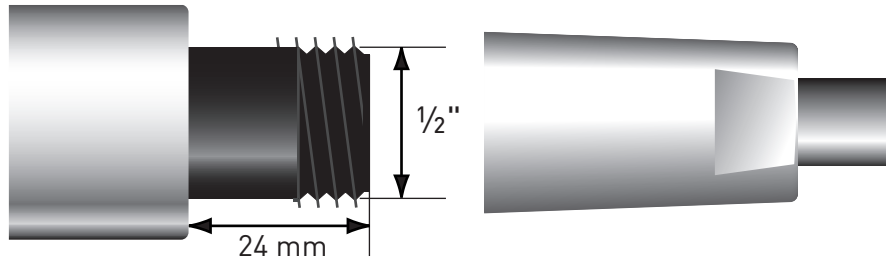

KWC Anschluss NEU
Raccord KWC NOUVEAU

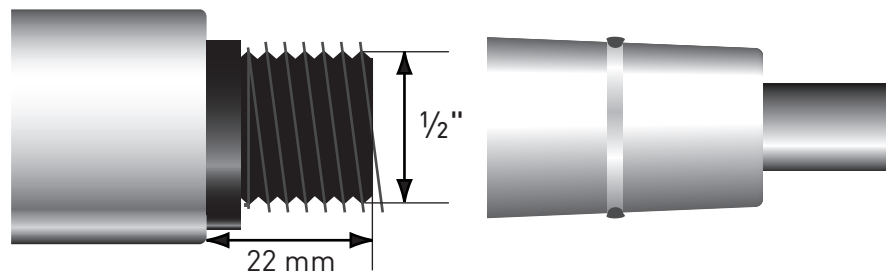

Anschlüsse (passt nicht zu KWC)

Raccords (non compatibles avec les raccords KWC)



Anschluss 1/2"
Raccord 1/2"

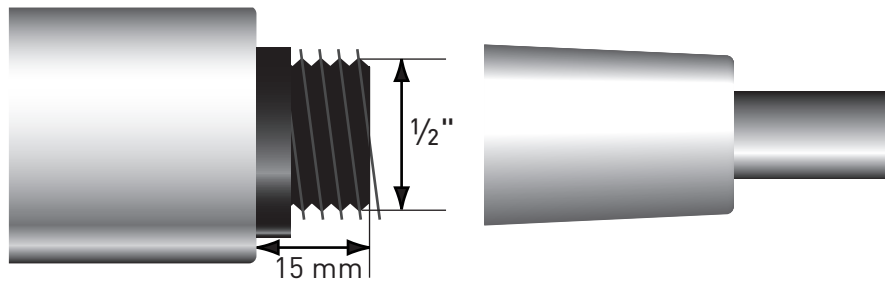

Anschluss 3/8"
Raccord 3/8"

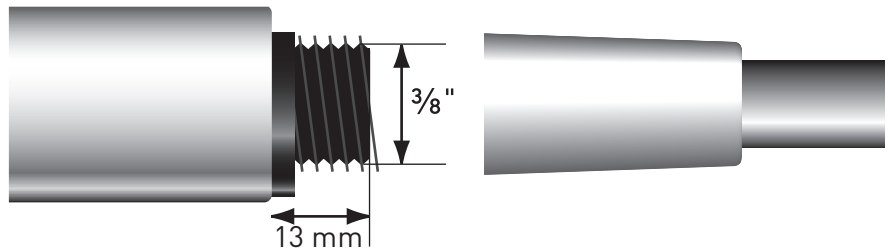



Küchenbrausen

Douchettes de cuisine

Farbsystem

Systeme de couleurs

Mit codiertem Farbsystem, um die richtige Brause für bestehende Komponenten zu finden. Das Farbsystem auf der Seite 7.3 abgebildet.

Avec un système de couleurs codées pour trouver la bonne douchette pour les composants existants. Le système de couleurs illustré à la page 7.3.

Strahlarten

Type de jets



Die Umstellung vom sanften Softstrahl zu einem kräftigen Brausestrahl erfolgt ganz einfach per Knopfdruck.

Le passage d'un jet doux à un jet de douche puissant se fait très facilement par simple pression sur un bouton.

Ecobooster Küchenbrause

Douche de cuisine Ecobooster



Speziell mit der Ecobooster-Funktion erhältlich. Einfaches Umstellen zwischen wassersparendem und starkem vollem Strahl. So kann man beim Topf füllen Zeit sparen und beim Gemüse waschen Wasser sparen, indem man auf den wassersparenden Strahl wechselt.

Spécialement disponible avec la fonction Ecobooster. Il est facile de passer du jet économiseur d'eau au jet puissant et plein. On peut ainsi gagner du temps en remplissant la casserole et économiser de l'eau en lavant les légumes en passant au jet économe en eau.

Rückflussverhinderer





















Clapet anti-retour

Die Küchenbrausen haben einen integrierten Rückflussverhinderer, die das Wasser vor Verunreinigungen schützt.

Les douches de cuisine sont équipées d'un clapet anti-retour intégré qui protège l'eau des impuretés.

Küche und Waschküche





Cuisine et buanderie



| | EAN-Nr. no EAN | Artikel Nr. no d'article | Beschreibung description | VPE ce | VE ue | UVP pro Stk. PVC CHF excl. | UVP pro Stk. PVC CHF incl. |
|--|--|---|---|-----------|---|----------------------------------|----------------------------------|
| Küchenbrause EcoBOOSTER | | Douchette cuisine EcoBOOSTER | | | | | |
|  <p>Mit Umschaltknopf von Spar- auf Normalbetrieb. (Sparbetrieb ca. 5 l/min / volle Leistung ca. 11 l/min bei 3 bar) <i>Avec bouton de commutation mode économie - mode normal. (Mode économie env. 5 l/min/ débit maximal env. 11 l/min à 3 bar)</i></p> |  7 611038 272722 | 07 0090 98 | verchromt, Anschluss: KWC alt <i>chromé, connexion: KWC ancien 1/2" ; EK: A / 5/11 l/min</i> | 3 |  | 71.76 | 77.29 |
| |     |  | | | | | |
| Küchenbrause KWC Domo/Star | | Douche. cuisine KWC Domo/Star | | | | | |
|  |  7 611038 247171 | 07 0000 98 | verchromt <i>chromé 1/2" ; EK: E</i> | 3 |  | 82.94 | 89.33 |
| |  7 611038 247188 | 07 0001 98 | weiss <i>blanc 1/2" ; EK: E</i> | 3 |  | 78.28 | 84.31 |
| | |  | | | | | |
| Ersatzsieb für KWC Domo/Star | | Tamis rechange KWC Domo/Star | | | | | |
| |  7 612158 064440 | 07 0031 94 | inkl. Innenteil / schwarz <i>incl. Pièce intér. / noir Z.504.214.106</i> | 1 |  | 35.88 | 38.64 |
| |  7 611038 175917 | 07 0005 96 | inkl. Innenteil (ab 2018) <i>incl. Pièce intérieure (2018)</i> | 1 |  | 11.84 | 12.75 |
| Ersatzdichtung SH70 EPDM | | Joint de rechange SH70 EPDM | | | | | |
| |  7 612158 054755 | 78 1317 96 | zu Küchenbrause KWC Domo/Star <i>pour KWC Domo/Star 1/2" / 18 x 9.5 x 4.7 mm ; Z.602.306</i> | 1 |  | 3.87 | 4.17 |



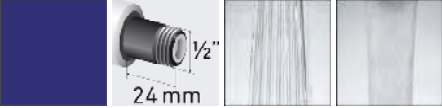

Küche und Waschküche







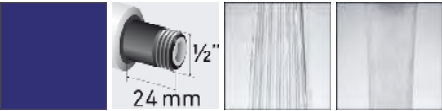

Cuisine et buanderie

| EAN-Nr. no EAN | Artikel Nr. no d'article | Beschreibung description | VPE ce | VE ue | UVP pro Stk. PVC CHF excl. | UVP pro Stk. PVC CHF incl. |
|-------------------|-----------------------------|-----------------------------|-----------|----------|----------------------------------|----------------------------------|
|-------------------|-----------------------------|-----------------------------|-----------|----------|----------------------------------|----------------------------------|

| Küchenbrause KWC ORCINO | | Douch. de cuisine KWC ORCINO | | | | | |
|---|--|------------------------------|---|---|---|---------------|---------------|
|  |  7 611038 388669 | 07 0026 98 | chrom chromé ½" ; EK: D / A 225 / ~ 15.4 l/min | 3 |  | 148.18 | 159.59 |
| |   | | | | | | |

| Ersatz-Brausesieb für ORCINO | | Tamis recharge pour ORCINO | | | | | |
|------------------------------|--|----------------------------|-----------------|---|---|--------------|--------------|
| |  7 612158 056094 | 07 0026 94 | schwarz noir | 1 |  | 25.16 | 27.10 |

| Küchenbrause KWC KONOS/WAMAS | | Douche cuisine KWC KONOS/WAMAS | | | | | |
|--|--|--------------------------------|---|---|---|---------------|---------------|
|  |  7 612158 239367 | 07 0019 96 | chrom chromé ½" / ~ 11.9 l/min ; Z.505.662.000 | 1 |  | 118.36 | 127.47 |
| |   | | | | | | |

| Küchenbrause New Look Plus | | Douch. cuisine New Look Plus | | | | | |
|---|--|------------------------------|--|---|---|--------------|--------------|
|  |  7 611038 315702 | 07 0164 98 | chrom chromé ½" ; EK: D / ~ 16.3 l/min | 3 |  | 50.33 | 54.20 |
| |  7 611038 315719 | 07 0165 98 | weiss blanc ½" ; EK: D / ~ 16.3 l/min | 3 |  | 47.53 | 51.19 |
| |  7 611038 315726 | 07 0166 98 | topas topaze ½" ; EK: D / ~ 16.3 l/min | 3 |  | 47.53 | 51.19 |
|   | | | | | | | |

KWC kompatibel
Adaptable avec KWC

Küche und Waschküche

Cuisine et buanderie

| EAN-Nr. no EAN | Artikel Nr. no d'article | Beschreibung description | VPE ce | VE ue | UVP pro Stk. PVC CHF excl. | UVP pro Stk. PVC CHF incl. |
|-------------------|-----------------------------|-----------------------------|-----------|----------|----------------------------------|----------------------------------|
|-------------------|-----------------------------|-----------------------------|-----------|----------|----------------------------------|----------------------------------|

| Küchenbrause EcoBOOSTER | Douchette cuisine EcoBOOSTER | | | | | |
|-------------------------|------------------------------|--|--|--|--|--|
|-------------------------|------------------------------|--|--|--|--|--|



07 0091 98

verchromt, Anschluss: KWC neu
chromé, connexion: KWC nouveau
1/2" ; EK: A / 5/11 l/min

3



74.56

80.30

Mit Umschaltknopf von Spar- auf Normalbetrieb.
(Sparbetrieb ca. 5 l/min / volle Leistung ca. 11 l/min bei 3 bar)

Avec bouton de commutation mode économie - mode normal.
(Mode économie env. 5 l/min / débit maximal env. 11 l/min à 3 bar)

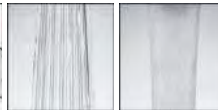

| Küchenbrause KWC DOMO NEW | Douch. de cuisine KWC DOMO NEW | | | | | |
|---------------------------|--------------------------------|--|--|--|--|--|
|---------------------------|--------------------------------|--|--|--|--|--|



07 0168 98

chrom
chromé
1/2" ; EK: E / A 225 / ~ 19.2 l/min

3



126.75

136.51



| Küchenbrause KWC Luna/Isla | Douchette cuis. KWC Luna/Isla | | | | | |
|----------------------------|-------------------------------|--|--|--|--|--|
|----------------------------|-------------------------------|--|--|--|--|--|



07 0018 96

chrom
chromé
1/2" / ~ 11.9 l/min ; Z.535.844.000

1



108.11



116.43







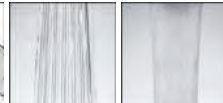

Küche und Waschküche







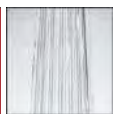

Cuisine et buanderie









| EAN-Nr. no EAN | Artikel Nr. no d'article | Beschreibung description | VPE ce | VE ue | UVP pro Stk. PVC CHF excl. | UVP pro Stk. PVC CHF incl. |
|-------------------|-----------------------------|-----------------------------|-----------|----------|----------------------------------|----------------------------------|
|-------------------|-----------------------------|-----------------------------|-----------|----------|----------------------------------|----------------------------------|

| Küchenbrause EcoBOOSTER | | Douchette cuisine EcoBOOSTER | | | | | |
|--|--|---|--|---|---|-------|-------|
|  <p>Mit Umschaltknopf von Spar- auf Normalbetrieb. (Sparbetrieb ca. 5 l/min / volle Leistung ca. 11 l/min bei 3 bar) Avec bouton de commutation mode économie - mode normal. (Mode économie env. 5 l/min / débit maximal env. 11 l/min à 3 bar)</p> |  7 611038 272715 | 07 0089 98 | verchromt, Anschluss: Standard chromé, connexion: standard 1/2" ; EK: A / 5/11 l/min | 3 |  | 71.76 | 77.29 |
| |      |  | | | | | |

NEW

| Küchenbrause City Pro | | Douchette cuisine City Pro | | | | | |
|--|--|--|-----------------------------|---|---|-------|-------|
|  |  7 612742 505946 | 07 0053 96 | verchromt chromé 3/8" | 1 |  | 87.60 | 94.35 |
| |    |  | | | | | |









| Küchenbrause Milor 2 | | Douchette cuisine Milor 2 | | | | | |
|---|---|--|--|---|---|-------|-------|
|  |  7 611038 297138 | 07 0112 98 | verchromt chromé 1/2" ; EK: C / 14.1 l/min | 3 |  | 85.74 | 92.34 |
| |      |  | | | | | |



| Küchenbrause Class 1+2 | | Douch. cuisine Arwa Class 1+2 | | | | | |
|---|---|--|--|---|---|-------|-------|
|  |  7 611038 297145 | 07 0118 98 | chrom chromé 1/2" ; EK: D / 17.2 l/min | 3 |  | 90.40 | 97.36 |
| |      |  | | | | | |









Küche und Waschküche









Cuisine et buanderie









| EAN-Nr. no EAN | Artikel Nr. no d'article | Beschreibung description | VPE ce | VE ue | UVP pro Stk. PVC CHF excl. | UVP pro Stk. PVC CHF incl. |
|-------------------|-----------------------------|-----------------------------|-----------|----------|----------------------------------|----------------------------------|
|-------------------|-----------------------------|-----------------------------|-----------|----------|----------------------------------|----------------------------------|

| Küchenbrause Similor | | Douchette cuisine Similor | | | | | |
|---|--|--|---|---|---|---------------|---------------|
|  |  7 611038 315771 | 07 0170 98 | chrom chromé 1/2" ; EK: C / 14.4 l/min | 3 |  | 115.56 | 124.46 |
|  |  |  1/2" 15 mm |  |  | LAUFEN | | |

| Ersatzsiebring Arwa Class 1+2 | | Tamis recharge Arwa Class 1+2 | | | | | |
|-------------------------------|--|-------------------------------|-----------------|---|---|--------------|--------------|
| |  7 612637 046240 | 07 0118 94 | chrom chromé | 1 |  | 22.37 | 24.09 |

| Küchenbrause Swing | | Douchette cuisine Swing | | | | | |
|--|--|---|--|--|---|---------------|---------------|
|  |  7 611038 328825 | 07 0152 98 | verchromt chromé 1/2" ; EK: C / 12.3 l/min | 3 |  | 101.58 | 109.40 |
|  |  |  1/2" 15 mm |  |  | FRANKE | | |









| Küchenbrause Rotondo | | Douchette cuisine Rotondo | | | | | |
|---|--|--|---|---|---|---------------|---------------|
|  |  7 611038 328832 | 07 0155 98 | chrom chromé 1/2" ; EK: B / 10.6 l/min | 3 |  | 112.77 | 121.45 |
|  |  |  1/2" 15 mm |  |  | FRANKE | | |













| Küchenbrause Novara | | Douchette cuisine Novara | | | | | |
|---|--|--|---|---|---|--------------|--------------|
|  |  7 611038 328849 | 07 0158 98 | chrom chromé 1/2" ; EK: C / 13.6 l/min | 3 |  | 87.60 | 94.35 |
|  |  |  1/2" 15 mm |  |  | FRANKE | | |







Küche und Waschküche







Cuisine et buanderie

| | EAN-Nr. no EAN | Artikel Nr. no d'article | Beschreibung description | VPE ce | VE ue | UVP pro Stk. PVC CHF excl. | UVP pro Stk. PVC CHF incl. |
|--|-------------------|-----------------------------|-----------------------------|-----------|----------|----------------------------------|----------------------------------|
|--|-------------------|-----------------------------|-----------------------------|-----------|----------|----------------------------------|----------------------------------|

| Küchenbrause Softline New | | Douchette cuisine Softline New | | | | | |
|---|---|--------------------------------|--|---|---|--------------|--------------|
|  |  7 611038 185282 | 07 0051 96 | verchromt / CASCADE® chromé / CASCADE® 1/2" ; ~ 12 l/min | 1 |  | 51.26 | 55.20 |
| |  7 611038 185381 | 07 0052 96 | verchromt / CASCADE® SLC® chromé / CASCADE® SLC® 1/2" ; ~ 12 l/min | 1 |  | 52.19 | 56.21 |
|     | | | | | | | |

| Küchenbrause New Look | | Douchette cuisine New Look | | | | | |
|---|--|----------------------------|--|---|--|--------------|--------------|
|  |  7 611038 315818 | 07 0174 98 | chrom chromé 1/2" ; EK: D / 15.7 l/min | 3 |  | 50.33 | 54.20 |
| |  7 611038 315825 | 07 0175 98 | weiss blanc 1/2" ; EK: D / 15.7 l/min | 3 |  | 47.53 | 51.19 |
| |  7 611038 315832 | 07 0176 98 | topas topaze 1/2" ; EK: D / 15.7 l/min | 3 |  | 47.53 | 51.19 |
|      | | | | | | | |

| Zugauslauf Arwa Twin | | Douchette cuisine Arwa Twin | | | | | |
|---|---|-----------------------------|--|---|---|--------------|--------------|
|  |  7 611038 297152 | 07 0128 98 | chrom chromé 3/8" ; EK: D / 15.6 l/min | 3 |  | 48.46 | 52.19 |
| |     LAUFEN | | | | | | |

| Zugauslauf Arwa Surf | | Douchette cuisine Arwa Surf | | | | | |
|---|---|-----------------------------|--|---|---|--------------|--------------|
|  |  7 611038 297169 | 07 0129 98 | chrom chromé 3/8" ; EK: D / 17.4 l/min | 3 |  | 51.26 | 55.20 |
| |     LAUFEN | | | | | | |

Küche und Waschküche



Cuisine et buanderie

| | EAN-Nr. <i>no EAN</i> | Artikel Nr. <i>no d'article</i> | Beschreibung <i>description</i> | VPE <i>ce</i> | VE <i>ue</i> | UVP pro Stk. <i>PVC CHF excl.</i> | UVP pro Stk. <i>PVC CHF incl.</i> |
|---|--|---|--|------------------|---|--|--|
| CASCADE® SLC® Innenteil | | CASCADE® SLC® Pièce intérieure | | | | | |
|  |  4 005897 142754 | 01 0805 90 | mit Dichtung/dunkelblau <i>avec joints/bleu foncé</i> M22 / M24 ; B = ~ 22.8 - 25.2 l/min | 1 |  | 6.24 | 6.72 |
| |  |  | | | | | |
| COIN SLOT Strahlregler | | COIN SLOT Aérateur | | | | | |
|  |  4 005897 104349 | 45 3030 90 | blau <i>bleu</i> M24x1 ; V = Full Flow | 1 |  | 8.01 | 8.63 |
| |  |  | | | | | |
| CACHÉ® HONEYCOMB Strahlregler | | CACHÉ® HONEYCOMB Aérateur | | | | | |
|  |  4 005897 072648 | 01 5151 90 | TT / M16.5x1 ; V = Full Flow | 1 |  | 10.07 | 10.84 |
| |  | | | | | | |
| HONEYCOMB Strahlregler | | HONEYCOMB Aérateur | | | | | |
|  |  7 611038 278458 | 10 9643 98 | verchromt <i>chromé</i> M18x1 ; EK: G / V = Full Flow | 5 |  | 11.74 | 12.65 |
| |  |  | | | | | |



Küche und Waschküche

Cuisine et buanderie



| EAN-Nr. no EAN | Artikel Nr. no d'article | Beschreibung description | VPE ce | VE ue | UVP pro Stk. PVC CHF excl. | UVP pro Stk. PVC CHF incl. |
|-------------------|-----------------------------|-----------------------------|-----------|----------|----------------------------------|----------------------------------|
|-------------------|-----------------------------|-----------------------------|-----------|----------|----------------------------------|----------------------------------|

| Glideflex® Auszugsschlauch | | Flexible de cuisine Glideflex® | | | | | |
|---|--|--------------------------------|--|---|---|-------|-------|
|  |  7 611038 242138 | 07 0092 96 | chrom-farbig/KWC kompatibel couleur chromé/adapt. à KWC 3/8" x 1/2" ; 150 cm | 1 |  | 50.33 | 54.20 |

- hohe Flexibilität und gute Knickfestigkeit
- PVC frei mit Trinkwasserzulassung KTW-A und W270
- mit komplett verchromten Anschlüssen
- *haute flexibilité et bonne résistance aux pliures*
- *sans PVC avec l'approbation pour l'eau potable KTW-A et W270*
- *livré avec connexions entièrement chromées*

| Glideflex® Auszugsschlauch | | Flexible de cuisine Glideflex® | | | | | |
|---|--|--------------------------------|---|---|---|-------|-------|
|  |  7 611038 315627 | 07 0190 98 | grau/KWC kompatibel gris/adaptable à KWC 3/8" x 1/2" ; 150 cm | 3 |  | 33.08 | 35.63 |

- hohe Flexibilität und gute Knickfestigkeit
- PVC frei mit Trinkwasserzulassung KTW-A und W270
- *haute flexibilité et bonne résistance aux pliures*
- *sans PVC avec l'approbation pour l'eau potable KTW-A et W270*

| Auszugsschlauch | | Flexible de cuisine | | | | | |
|---|--|---------------------|---|---|---|-------|-------|
|  |  7 612158 053178 | 07 0030 96 | Metall verchromt Métal chromé 3/8" x 1/2" / 150 cm ; Z.501.997.000 | 1 |  | 60.58 | 65.24 |



Für Küchenarmaturen mit 3/8" Anschluss.
Pour robinetterie avec raccordement 3/8".



Küche und Waschküche



Cuisine et buanderie

| EAN-Nr. no EAN | Artikel Nr. no d'article | Beschreibung description | VPE ce | VE ue | UVP pro Stk. PVC CHF excl. | UVP pro Stk. PVC CHF incl. |
|-------------------|-----------------------------|-----------------------------|-----------|----------|----------------------------------|----------------------------------|
|-------------------|-----------------------------|-----------------------------|-----------|----------|----------------------------------|----------------------------------|

| Auszugsschlauch ORCINO/WAMAS | | Flexible de cuisine WAMAS | | | | | |
|---|--|---------------------------|--|---|---|-------|-------|
|  |  7 612158 503659 | 07 0029 96 | Metall verchromt Métal chromé M14x1 x 1/2" / 140 cm ; Z.536.316.000 | 1 |  | 70.83 | 76.28 |





Für Küchenarmaturen mit M14x1 Anschluss.
Pour robinetterie avec raccordement M14x1.

| Glideflex® Auszugsschlauch | | Flexible de cuisine Glideflex® | | | | | |
|--|--|--------------------------------|--|---|---|-------|-------|
|  |  7 611038 315634 | 07 0191 98 | grau/KWC kompatibel gris/adaptable à KWC M14x1 x 1/2" ; 140 cm | 3 |  | 51.26 | 55.20 |



- hohe Flexibilität und gute Knickfestigkeit
- PVC frei mit Trinkwasserzulassung KTW-A und W270
- haute flexibilité et bonne résistance aux pliures
- sans PVC avec l'approbation pour l'eau potable KTW-A et W270

| Auszugsschlauch Isla | | Flexible de cuisine Isla | | | | | |
|---|--|--------------------------|--|---|---|-------|-------|
|  |  7 612158 504113 | 07 0182 96 | Nylon nylon M14x1 x 1/2" / 140 cm ; Z.537.382.000 | 1 |  | 66.17 | 71.26 |





Für Küchenarmaturen mit M14x1 Anschluss.
Pour robinetterie avec raccordement M14x1.

Küche und Waschküche



Cuisine et buanderie

| EAN-Nr. no EAN | Artikel Nr. no d'article | Beschreibung description | VPE ce | VE ue | UVP pro Stk. PVC CHF excl. | UVP pro Stk. PVC CHF incl. |
|-------------------|-----------------------------|-----------------------------|-----------|----------|----------------------------------|----------------------------------|
|-------------------|-----------------------------|-----------------------------|-----------|----------|----------------------------------|----------------------------------|

| Auszugsschlauch DOMO NEW | | Flexible de cuisine DOMO NEW | | | | | |
|---|--|------------------------------|--|---|---|--------------|--------------|
|  |  7 611038 278175 | 07 0028 98 | Metall verchromt <i>métal chromé</i> M14x1 x 1/2" ; 140 cm | 3 |  | 63.37 | 68.25 |





Für Küchenarmaturen mit M14x1 Anschluss.
Pour robinetterie avec raccordement M14x1.

| Glideflex® Auszugsschlauch | | Flexible de cuisine Glideflex® | | | | | |
|--|--|--------------------------------|---|---|---|--------------|--------------|
|  |  7 611038 315641 | 07 0192 98 | grau <i>gris</i> 3/8" x 1/2" ; 150 cm | 3 |  | 28.42 | 30.61 |



- hohe Flexibilität und gute Knickfestigkeit
- PVC frei mit Trinkwasserzulassung KTW-A und W270
- *haute flexibilité et bonne résistance aux pliures*
- *sans PVC avec l'approbation pour l'eau potable KTW-A et W270*

| Glideflex® Auszugsschlauch | | Flexible de cuisine Glideflex® | | | | | |
|---|--|--------------------------------|--|---|---|--------------|--------------|
|  |  7 611038 315658 | 07 0193 98 | grau <i>gris</i> M15x1 x 1/2" ; 150 cm | 3 |  | 29.82 | 32.12 |











- hohe Flexibilität und gute Knickfestigkeit
- PVC frei mit Trinkwasserzulassung KTW-A und W270
- *haute flexibilité et bonne résistance aux pliures*
- *sans PVC avec l'approbation pour l'eau potable KTW-A et W270*





Küche und Waschküche

Cuisine et buanderie



| | EAN-Nr. no EAN | Artikel Nr. no d'article | Beschreibung description | VPE ce | VE ue | UVP pro Stk. PVC CHF excl. | UVP pro Stk. PVC CHF incl. |
|--|-------------------|-----------------------------|-----------------------------|-----------|----------|----------------------------------|----------------------------------|
|--|-------------------|-----------------------------|-----------------------------|-----------|----------|----------------------------------|----------------------------------|





| Auszugsschlauch | | Flexible de cuisine | | | | | |
|---|---|---------------------|---|---|---|--------------|--------------|
|  |  | 07 0065 96 | Metall verchromt <i>métal chromé</i> 3/8" x 1/2" ; 150 cm | 1 |  | 28.42 | 30.61 |
| |  | | | | | | |

| Auszugsschlauch | | Flexible de cuisine | | | | | |
|---|---|---------------------|--|---|---|--------------|--------------|
|  |  | 07 0180 96 | Metall verchromt <i>métal chromé</i> 3/8" x 1/2" / 130 cm ; 1.05663.100.000 | 1 |  | 56.85 | 61.23 |
| |  | LAUFEN | | | | | |

| Glideflex® Auszugsschlauch | | Flexible de cuisine Glideflex® | | | | | |
|---|---|--------------------------------|--|---|--|--------------|--------------|
|  |  | 07 0194 98 | grau / zu Twin u. Surf <i>gris/ p. Twin et Surf</i> 3/8" x 3/8" ; 150 cm | 3 |  | 50.33 | 54.20 |
| |  | | | | | | |

- hohe Flexibilität und gute Knickfestigkeit
- PVC frei mit Trinkwasserzulassung KTW-A und W270
- *haute flexibilité et bonne résistance aux pliures*
- *sans PVC avec l'approbation pour l'eau potable KTW-A et W270*



| Rückzuggewicht | | Poids de rappel | | | | | |
|---|---|-------------------|---|----|---|--------------|--------------|
|  |  | 07 0066 98 | zu Metall-Küchenschlauch <i>pour flexible en métal</i> | 10 |  | 25.63 | 27.60 |
| |  | 07 0067 98 | zu Kunststoff-Küchenschlauch <i>pour flexible en nylon</i> | 10 |  | 25.63 | 27.60 |

| Reduktion | | Réduction | | | | | |
|---|---|-------------------|---|---|---|--------------|--------------|
|  |  | 07 0101 98 | Messing verchromt <i>laiton chromé</i> 3/8" x M15x1 | 5 |  | 10.07 | 10.84 |
| |  | | | | | | |

Küche und Waschküche



Cuisine et buanderie



| EAN-Nr. no EAN | Artikel Nr. no d'article | Beschreibung description | VPE ce | VE ue | UVP pro Stk. PVC CHF excl. | UVP pro Stk. PVC CHF incl. |
|-------------------|-----------------------------|-----------------------------|-----------|----------|----------------------------------|----------------------------------|
|-------------------|-----------------------------|-----------------------------|-----------|----------|----------------------------------|----------------------------------|

| Industrieküchenbrause Avero | | Douch. cuisine industrie Avero | | | | |
|---|-------------------|--------------------------------|---|---|---------------|---------------|
|  | 07 0075 98 | verchromt chromé 1/2" | 1 |  | 133.27 | 143.53 |



- Robuste und handliche Ausführung in Messing verchromt
- Mit wärmeisolierendem Kunststoffgriff
- Anschlussgewinde 1/2"
- Druck max. 6 bar, Temperatur max. 65°
- Exécution robuste et maniable en laiton chromé
- Avec poignée en plastique isolant thermique
- Filetage de raccordement 1/2"
- Pression max. 6 bars, Temp. max. 65°C



| Ersatzsieb zu Avero & Braga | | Tamis rechange p. Avero/Braga | | | | |
|---|-------------------|-------------------------------|---|---|--------------|--------------|
|  | 07 0075 94 | weiss blanc | 1 |  | 13.05 | 14.05 |
| | 07 0076 94 | schwarz noir | 1 |  | 13.05 | 14.05 |

| Gastroschlauch DN 10 | | Flexible de cuisine ind. DN 10 | | | | |
|---|-------------------|---|---|---|---------------|---------------|
|  | 07 0100 96 | IG x IG / Metall F x F / métal 1/2" x 1/2" ; 105 cm | 1 |  | 100.65 | 108.40 |

Küche und Waschküche



Cuisine et buanderie

| EAN-Nr. no EAN | Artikel Nr. no d'article | Beschreibung description | VPE ce | VE ue | UVP pro Stk. PVC CHF excl. | UVP pro Stk. PVC CHF incl. |
|-------------------|-----------------------------|-----------------------------|-----------|----------|----------------------------------|----------------------------------|
|-------------------|-----------------------------|-----------------------------|-----------|----------|----------------------------------|----------------------------------|

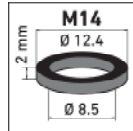

| Gummidichtung | | Joint en caoutchouc | | | | | |
|---|--|---------------------|-------------------------|---|---|-------------|-------------|
|  |  7 611038 170042 | 78 1319 94 | M14 ; 8.5 x 12.4 x 2 mm | 1 |  | 1.07 | 1.15 |

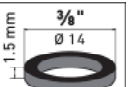
Für Auszugsschläuche
Pour flexibles de cuisine



| Gummidichtung | | Joint en caoutchouc | | | | | |
|---|--|---------------------|--|---|---|-------------|-------------|
|  |  7 611038 140359 | 78 6520 96 | Polybeutel à 5 Stk. polybag à 5 pcs 3/8" ; 14 x 9 x 1,5 mm | 1 |  | 1.58 | 1.71 |

Für Auszugsschläuche
Pour flexibles de cuisine

| Gummidichtung | | Joint en caoutchouc | | | | | |
|---|---|---------------------|-----------------------|---|--|-------------|-------------|
|  |  8 711962 020518 | 78 1316 90 | 1/2" ; 10 x 19 x 4 mm | 1 |  | 1.12 | 1.20 |

Für Auszugsschläuche
Pour flexibles de cuisine

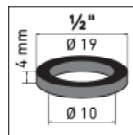

Küche und Waschküche

Cuisine et buanderie

| EAN-Nr. no EAN | Artikel Nr. no d'article | Beschreibung description | VPE ce | VE ue | UVP pro Stk. PVC CHF excl. | UVP pro Stk. PVC CHF incl. |
|-------------------|-----------------------------|-----------------------------|-----------|----------|----------------------------------|----------------------------------|
|-------------------|-----------------------------|-----------------------------|-----------|----------|----------------------------------|----------------------------------|

Twister Reinigungsmittel Nettoyant Twister



7 612142 216725

FRANKE

35 1836 94

125 ml

1



18.55

19.97

Reinigungspaste für
Chromnickelstahl Spülen,
Becken und Abdeckungen.
*Pâte nettoyante pour les éviers,
bassins et plans de travail en acier
inox.*

Inox Cream Reinigungsmittel Nettoyant Inox Cream



7 611609 050025

FRANKE

35 1837 94

250 ml

1



18.55

19.97

Reinigungspaste für
Chromnickelstahl Spülen,
Becken und Abdeckungen.
*Pâte nettoyante pour les éviers,
bassins et plans de travail en acier
inox.*

Armaturenbankverstärkung Renfort p. fixati. de robinet.



7 611038 185367

FRANKE

35 1911 98

Kunststoff
plastique

5



19.57

21.08

Verstreben Sie die
Armaturenbank durch die
neuartige und leicht zu
montierende
Armaturenbankverstärkung. Sie
gibt der Armatur zusätzlichen
Halt und unterstützt
die Stabilität.
*Entretoisez la fixation de
robinetterie à l'aide du nouveau
renfort pour plage de robinetterie
facile à monter. Il donne
un appui supplémentaire aux
robinets et renforce la stabilité.*

Küche und Waschküche

Cuisine et buanderie

| EAN-Nr. no EAN | Artikel Nr. no d'article | Beschreibung description | VPE ce | VE ue | UVP pro Stk. PVC CHF excl. | UVP pro Stk. PVC CHF incl. |
|-------------------|-----------------------------|-----------------------------|-----------|----------|----------------------------------|----------------------------------|
|-------------------|-----------------------------|-----------------------------|-----------|----------|----------------------------------|----------------------------------|

| | |
|---------------------------|---------------------------------------|
| Einbaseifenspender | Distribut. de sav. à encastrer |
|---------------------------|---------------------------------------|



35 1918 98

H: 230 mm / Ø 53 mm ; 280 ml

1



32.15

34.63

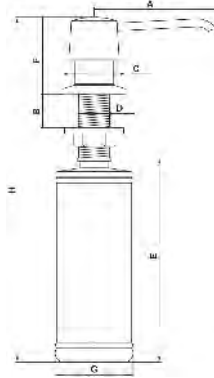

- | | |
|---|--|
| A = Ausladung des Pumpenkopfes: 90 mm | A = Surplomb de la tête de pompe: 90 mm |
| B = Dicke der Arbeitsplatte max. 41 mm | B = Épaisseur maximale du plan de travail: 41 mm |
| C = Durchmesser Rosette: Ø 48 mm | C = Diamètre de la rosace: Ø 48 mm |
| D = Einbaudurchmesser (Bohrloch): Ø 25 mm | D = Diamètre d'encastrement (perçage du plan): Ø 25 mm |
| E = Flaschenhöhe: 156 mm | E = Hauteur du flacon: 156 mm |
| F = Höhe des Pumpenkopfes: 58 mm | F = Hauteur de la tête de pompe: 58 mm |
| G = Flaschendurchmesser: Ø 59 mm | G = Diamètre du flacon: Ø 59 mm |
| H = Gesamthöhe 260 mm | H = Hauteur totale: 260 mm |

| | |
|---------------------------------------|---------------------------------------|
| Handtuchhalter 2-arm. auszieh. | Porte-serviette 2-bras télesc. |
|---------------------------------------|---------------------------------------|



35 1917 97

aluminium poliert
aluminium astiquer
Ø 16 mm ; L 430 mm

1



36.81

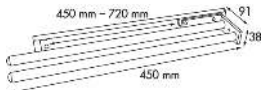

39.65



Material: Aluminium poliert
Für Seiten- oder Untermontage
Aluminium poli
Pour montage latéral ou inférieur

Küche und Waschküche

Cuisine et buanderie

| | EAN-Nr. <i>no EAN</i> | Artikel Nr. <i>no d'article</i> | Beschreibung <i>description</i> | VPE <i>ce</i> | VE <i>ue</i> | UVP pro Stk. <i>PVC</i> CHF excl. | UVP pro Stk. <i>PVC</i> CHF incl. |
|---|--|------------------------------------|---|------------------|---|---|---|
| Rollmatte | Égouttoir roulant | | | | | | |
|  |  7 612142 241574 | 35 1912 97 | Edelstahl <i>en acier inox</i> 468 x 420 x 9 mm | 20 |  | 126.75 | 136.51 |

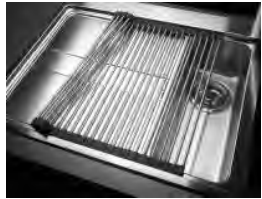



- zusammengerollt gut zu versorgen
 - beidseitig vom Becken einsetzbar
 - über dem Becken einsetzbar, stabil genug um eine volle Pfanne abzustellen
 - zu gebrauchen als Tropfteil und als Pfannen- oder Backofenblech Untersatz
 - abwaschbar in der Maschine und von Hand
 - rostfreier Stahl
 - qualitativ hochwertiges Material
- *S'enroule et permet un rangement facile*
 - *Utilisable des deux côtés*
 - *Se pose par-dessus l'évier et est suffisamment stable pour y déposer une casserole*
 - *Peut être utilisé comme égouttoir ou comme sous-plat*
 - *Lavage en machine ou à la main*
 - *Acier inoxydable*
 - *Matériel de qualité supérieure*

Küche und Waschküche



Cuisine et buanderie

| EAN-Nr. no EAN | Artikel Nr. no d'article | Beschreibung description | VPE ce | VE ue | UVP pro Stk. PVC CHF excl. | UVP pro Stk. PVC CHF incl. |
|-------------------|-----------------------------|-----------------------------|-----------|----------|----------------------------------|----------------------------------|
|-------------------|-----------------------------|-----------------------------|-----------|----------|----------------------------------|----------------------------------|

| Mobiler Tropfteil | | Égouttoir amovible | | | | |
|---|--|--------------------|--|---|---|----------------------------|
|  |  7 612980 584222 | 35 1916 97 | Edelstahl acier inox 333 x 417 x 22 mm | 1 |  | 157.85 170.— |



- als Tropfteil beidseitig vom Becken einsetzbar
 - Wasser fließt direkt ins Becken
 - als Ablagefläche über dem Becken einsetzbar
 - abwaschbar in der Maschine und von Hand
 - Kunststoffrand schützt vor Beschädigungen
 - rostfreier Stahl
 - qualitativ hochwertiges Material
- Égouttoir utilisable des deux côtés
 - L'eau s'écoule directement dans l'évier
 - Peut être utilisé comme ablage
 - L'eau s'écoule directement sous-plat
 - Lavage en machine ou à la main
 - Protection des bords en matière plastique
 - Acier inoxydable
 - Matériel de qualité supérieure



| Geschirrkorb | | Panier à couverts | | | | |
|---|--|-------------------|---|---|---|---------------------------|
|  |  7 611038 426026 | 35 1914 96 | Edelstahl acier inoxydable 295 x 375 x 134 mm | 1 |  | 71.76 77.29 |



Küche und Waschküche



Cuisine et buanderie





| EAN-Nr. no EAN | Artikel Nr. no d'article | Beschreibung description | VPE ce | VE ue | UVP pro Stk. PVC CHF excl. | UVP pro Stk. PVC CHF incl. |
|-------------------|-----------------------------|-----------------------------|-----------|----------|----------------------------------|----------------------------------|
|-------------------|-----------------------------|-----------------------------|-----------|----------|----------------------------------|----------------------------------|

| Abtropfbecken | | Panier égouttoir | | | | | |
|---|--|------------------|--------------------------------------|---|---|-------|-------|
|  |  7 612197 018374 | 35 1900 41 | weiss blanc 177 x 315 x 112 mm | 1 |  | 24.23 | 26.10 |



aus Luran Kunststoff
en plastique Luran

| Abflusssieb | | Grille pour évier | | | | | |
|--|--|-------------------|-------------------------------|---|---|------|------|
|  |  7 611038 053697 | 35 2580 98 | INOX Ø 40-70 mm ; 1 Stk/pc | 5 |  | 5.64 | 6.07 |

| Standrohr | | Surverse | | | | | |
|---|--|------------|--------------------------------------|---|---|------|-------|
|  |  7 611038 350260 | 35 2041 98 | weiss blanc 160 mm ; Ø ~ 50 mm | 3 |  | 9.51 | 10.24 |
| |  7 611038 350383 | 35 2059 98 | grau gris 160 mm ; Ø ca. 50 mm | 3 |  | 9.51 | 10.24 |



Küche und Waschküche

Cuisine et buanderie

| EAN-Nr. no EAN | Artikel Nr. no d'article | Beschreibung description | VPE ce | VE ue | UVP pro Stk. PVC CHF excl. | UVP pro Stk. PVC CHF incl. |
|-------------------|-----------------------------|-----------------------------|-----------|----------|----------------------------------|----------------------------------|
|-------------------|-----------------------------|-----------------------------|-----------|----------|----------------------------------|----------------------------------|

| Standrohr | Surverse | | | | | |
|-----------|----------|--|--|--|--|--|
|-----------|----------|--|--|--|--|--|



| | | | | | |
|------------|------------------------------|---|--|-------|-------|
| 35 2110 98 | INOX 150 mm ; Ø ca. 50 mm | 3 | | 25.16 | 27.10 |
|------------|------------------------------|---|--|-------|-------|



| Abflusssieb mit Knopf | Grille pour évier avec poignée | | | | | |
|-----------------------|--------------------------------|--|--|--|--|--|
|-----------------------|--------------------------------|--|--|--|--|--|



| | | | | | |
|------------|-----------------|---|--|------|------|
| 35 2210 98 | INOX Ø 45 mm | 5 | | 5.50 | 5.92 |
|------------|-----------------|---|--|------|------|



| Abflusssieb mit Stift | Grille pour évier avec tige | | | | | |
|-----------------------|-----------------------------|--|--|--|--|--|
|-----------------------|-----------------------------|--|--|--|--|--|





| | | | | | |
|------------|-----------------|---|--|------|------|
| 35 2220 98 | INOX Ø 45 mm | 5 | | 5.50 | 5.92 |
|------------|-----------------|---|--|------|------|



Küche und Waschküche



Cuisine et buanderie

| | EAN-Nr. no EAN | Artikel Nr. no d'article | Beschreibung description | VPE ce | VE ue | UVP pro Stk. PVC CHF excl. | UVP pro Stk. PVC CHF incl. |
|--|-------------------|-----------------------------|-----------------------------|-----------|----------|----------------------------------|----------------------------------|
|--|-------------------|-----------------------------|-----------------------------|-----------|----------|----------------------------------|----------------------------------|

| Siebkorbstößel | | Panier à pousoir | | | | | |
|---|--|------------------|------------------------------------|---|---|-------|-------|
|  |  7 611038 172244 | 35 2420 98 | Edelstahl acier inox Ø 85 mm | 2 |  | 29.36 | 31.62 |



FRANKE

zu Integralventil
pour soupape intégré

| Siebkorbstopfen | | Panier à bouchon | | | | | |
|--|--|------------------|------------------------------------|---|---|-------|-------|
|  |  7 611038 172251 | 35 2421 98 | Edelstahl acier inox Ø 85 mm | 2 |  | 31.22 | 33.62 |



FRANKE

zu Integralventil
pour soupape intégré

| Stopfventil ohne Überlauf | | Soupape à panier sans surverse | | | | | |
|---|--|--------------------------------|---|---|---|-------|-------|
|  |  7 612981 160432 | 35 1846 96 | mit Entlüfter avec exhausteur intégré 3 1/2" Ø115 | 1 |  | 90.40 | 97.36 |

FRANKE















Semi-Integral
semi-intégré

| Stößel komplett | | Poussoir complet | | | | | |
|---|--|------------------|-----------------|---|---|-------|-------|
|  |  7 611038 369415 | 35 2310 98 | INOX Ø 49 mm | 5 |  | 29.36 | 31.62 |

FRANKE

Küche und Waschküche



Cuisine et buanderie

| | EAN-Nr. no EAN | Artikel Nr. no d'article | Beschreibung description | VPE ce | VE ue | UVP pro Stk. PVC CHF excl. | UVP pro Stk. PVC CHF incl. |
|---|---|---------------------------------------|-----------------------------|-----------|---|----------------------------------|----------------------------------|
| Ersatzdichtung zu Stössel | | Joint pour Pousoir | | | | | |
|  |  7 612197 022548 | 35 2310 90 | Ø 50 x 5 mm | 1 |  | 14.54 | 15.66 |
| Siebkorb zu Stössel | | Panier de récupération | | | | | |
|  |  7 611038 047467 FRANKE | 35 2320 98 | INOX Ø 92 mm | 5 |  | 25.16 | 27.10 |
| Siebkorb komplett | | Soupape de fermeture av.panier | | | | | |
|  |  7 611038 082802 FRANKE | 35 2410 98 | INOX Ø 83 mm | 5 |  | 35.88 | 38.64 |
| Standrohrventil | | Soupape à surverse | | | | | |
|  |  7 611038 369439 FRANKE | 35 1845 98 | INOX 1½" | 5 |  | 21.90 | 23.59 |
| Stopfenventil | | Soupape à bouchon | | | | | |
|  |  7 612142 110313 FRANKE | 35 1847 96 | INOX 1½" | 1 |  | 20.97 | 22.58 |



Küche und Waschküche

Cuisine et buanderie

| EAN-Nr. no EAN | Artikel Nr. no d'article | Beschreibung description | VPE ce | VE ue | UVP pro Stk. PVC CHF excl. | UVP pro Stk. PVC CHF incl. |
|-------------------|-----------------------------|-----------------------------|-----------|----------|----------------------------------|----------------------------------|
|-------------------|-----------------------------|-----------------------------|-----------|----------|----------------------------------|----------------------------------|





| Drehknopf | | Bouton de commande | | | | | |
|---|--|--------------------|---------------------|---|---|-------|-------|
|  |  7 611038 369446 | 35 1840 98 | verchromt chromé | 5 |  | 25.16 | 27.10 |

FRANKE

| Kabelzug | | Cable conduit | | | | | |
|---|--|---------------|--------|---|---|-------|-------|
|  |  7 612981 038045 | 35 1842 96 | 500 mm | 1 |  | 25.16 | 27.10 |



FRANKE

NEW

| Raumspär-Stösselventil | | Soupape à pousoir à faible en | | | | | |
|---|--|-------------------------------|---|---|---|--------|--------|
|  |  7 612980 495115 | 35 2422 96 | ohne Überlauf/mit Kabelzug Ø 3 1/2" ; 600 mm | 1 |  | 88.54 | 95.35 |
| |  7 612980 495122 | 35 2423 96 | mit Überlauf/mit Kabelzug Ø 3 1/2" ; 600 mm | 1 |  | 114.63 | 123.46 |

FRANKE

NEW



| Dichtungsset | | Set de joints | | | | | |
|---|--|---------------|---|---|---|-------|-------|
|  |  7 612142 252600 | 35 2424 96 | zu Siebkorb pour soupape 47 x 27 x 2.5 mm ; 3 Stk/pcs | 1 |  | 19.11 | 20.58 |

FRANKE











Küche und Waschküche









Cuisine et buanderie

| EAN-Nr. no EAN | Artikel Nr. no d'article | Beschreibung description | VPE ce | VE ue | UVP pro Stk. PVC CHF excl. | UVP pro Stk. PVC CHF incl. |
|-------------------|-----------------------------|-----------------------------|-----------|----------|----------------------------------|----------------------------------|
|-------------------|-----------------------------|-----------------------------|-----------|----------|----------------------------------|----------------------------------|

| Stopfen zu Ablaufventil | | Bouchon pour soupape | | | | | |
|---|--|----------------------|------------------------------|---|--|-------------|-------------|
|  |  7 611038 003494 | 35 2550 98 | schwarz noir Ø 50.5 mm | 3 |  1 | 6.80 | 7.33 |



| Badestopfen | | Bouchon pour évier | | | | | |
|--|--|--------------------|--|---|--|-------------|-------------|
|  |  7 611038 082352 | 35 2500 98 | schwarz noir Ø 38.5 mm ; 1 Stk/pc | 5 |  1 | 3.08 | 3.31 |
| |  7 611038 082369 | 35 2510 98 | schwarz noir Ø 40.5 mm ; 1 Stk/pc | 5 |  1 | 3.08 | 3.31 |
| |  7 611038 082376 | 35 2520 98 | schwarz noir Ø 43.5 mm ; 1 Stk/pc | 5 |  1 | 3.22 | 3.46 |
| |  7 611038 082383 | 35 2530 98 | schwarz noir Ø 38.5 - 50 mm ; 1 Stk/pc | 5 |  1 | 3.22 | 3.46 |
| |  7 611038 178109 | 35 2540 98 | schwarz noir Ø 45.5 mm | 5 |  1 | 3.22 | 3.46 |

| Abflusssieb | | Grille pour évier | | | | | |
|---|--|-------------------|---------------------------------------|---|--|-------------|-------------|
|  |  4 009432 036416 | 35 2560 98 | weiss blanc Ø 60 mm ; 1 Stk/pc | 5 |  1 | 2.56 | 2.76 |
| |  4 009432 037413 | 35 2570 98 | weiss blanc Ø 70 mm ; 1 Stk/pc | 5 |  1 | 2.80 | 3.01 |
| |  7 611038 113827 | 35 7847 10 | chrom chromé Ø 60 mm ; 1 Stk/pc | 5 |  1 | 5.03 | 5.42 |
| |  7 611038 113742 | 35 7867 10 | chrom chromé Ø 70 mm ; 1 Stk/pc | 5 |  1 | 5.13 | 5.52 |

Küche und Waschküche

Cuisine et buanderie

| EAN-Nr. no EAN | Artikel Nr. no d'article | Beschreibung description | VPE ce | VE ue | UVP pro Stk. PVC CHF excl. | UVP pro Stk. PVC CHF incl. |
|-------------------|-----------------------------|-----------------------------|-----------|----------|----------------------------------|----------------------------------|
|-------------------|-----------------------------|-----------------------------|-----------|----------|----------------------------------|----------------------------------|

Abflusssieb

Grille pour évier



35 2580 98

INOX
Ø 40-70 mm ; 1 Stk/pc

5



5.64

6.07



Badekettchen

Chaînette



35 9100 98

verchromt
chromé
26 cm

5



4.47

4.82



35 9110 98

verchromt
chromé

5



5.36

5.77

Hahnlochstopfen

Bouchon pour trou robinet



35 2944 94

verchromt
chromé
Ø 44 mm ; 40 mm

10



23.76

25.59



35 2952 94

verchromt
chromé
Ø 52 mm ; 40 mm

5



43.80

47.17



35 3040 94

verchromt
chromé
Ø 48 mm ; 70 mm

10





20.04

21.58



Küche und Waschküche

Cuisine et buanderie



| | EAN-Nr. <i>no EAN</i> | Artikel Nr. <i>no d'article</i> | Beschreibung <i>description</i> | VPE <i>ce</i> | VE <i>ue</i> | UVP pro Stk. <i>PVC</i> CHF excl. | UVP pro Stk. <i>PVC</i> CHF incl. |
|--|--------------------------|------------------------------------|------------------------------------|------------------|-----------------|---|---|
|--|--------------------------|------------------------------------|------------------------------------|------------------|-----------------|---|---|

| Behälter Single | Poubelle Single | | | | | | |
|---|--|------------|--|---|---|-------|-------|
|  |  7 610316 808288 | 07 0350 94 | für Normsäcke 35 l <i>pour sachet norme 35 l</i> 35 L ; L: 29 x B: 29 x H: 45 cm | 1 |  | 56.85 | 61.23 |

MÜLLEX

| Behälter Modul | Poubelle Modul | | | | | | |
|--|--|------------|--|---|---|-------|-------|
|  |  7 610316 801401 | 07 0351 94 | für Normsäcke 17 l <i>pour sachet norme 17 l</i> 17 L ; L: 22 x B: 15 x H: 45 cm | 1 |  | 45.20 | 48.68 |

MÜLLEX

| Kompostbehälter Terra | Bac à compost Terra | | | | | | |
|---|--|------------|--|---|---|-------|-------|
|  |  7 610316 801395 | 07 0352 94 | für Kompostsäcke 5 l <i>pour sachet compost 5 l</i> 5 L ; L: 24 x B: 15 x H: 25.2 cm | 1 |  | 27.96 | 30.11 |



MÜLLEX

inkl. 2 Lagerzapfen
incl. 2 tourillons embloitable



Küche und Waschküche

Cuisine et buanderie



| EAN-Nr. no EAN | Artikel Nr. no d'article | Beschreibung description | VPE ce | VE ue | UVP pro Stk. PVC CHF excl. | UVP pro Stk. PVC CHF incl. |
|-------------------|-----------------------------|-----------------------------|-----------|----------|----------------------------------|----------------------------------|
|-------------------|-----------------------------|-----------------------------|-----------|----------|----------------------------------|----------------------------------|

| Putzmittelauszug | | Etagère exten. p. prod.nettoy. | | | | | |
|---|--|--------------------------------|--|---|---|--------|--------|
|  |  7 610316 805027 | 07 0353 94 | mit Rollenbehälter a. support pour sac poubelle L: 48.5 x B: 11.2 x H: 40.5 cm | 1 |  | 112.77 | 121.45 |



MÜLLEX

| Deckel zu COMPO, KIPP, COMFORT | | Couvercle p. COMPO, KIPP, COMFORT | | | | | |
|---|--|-----------------------------------|--------------------|---|---|-------|-------|
|  |  7 610316 814104 | 07 0354 94 | 48 x 34.6 x 4.5 cm | 1 |  | 40.54 | 43.66 |



MÜLLEX

| Deckel zu SINGLE und OEKONOM | | Couvercle p. SINGLE et OEKONOM | | | | | |
|---|--|--------------------------------|--------------------|---|---|-------|-------|
|  |  7 610316 808578 | 07 0355 94 | 33 x 34.5 x 4.3 cm | 1 |  | 38.68 | 41.65 |

MÜLLEX

| Mitnehmer zu COMPO und KIPP | | Levier pour COMPO et KIPP | | | | | |
|---|--|---------------------------|--|---|---|-------|-------|
|  |  7 611038 369309 | 07 0356 98 | | 5 |  | 10.72 | 11.54 |



MÜLLEX

| Zughaken | | Crochet | | | | | |
|---|--|------------|-----------|---|---|------|------|
|  |  7 611038 369316 | 07 0357 98 | L = 80 mm | 5 |  | 6.62 | 7.13 |



MÜLLEX

Küche und Waschküche



Cuisine et buanderie

| | EAN-Nr. no EAN | Artikel Nr. no d'article | Beschreibung description | VPE ce | VE ue | UVP pro Stk. PVC CHF excl. | UVP pro Stk. PVC CHF incl. |
|---|--|-----------------------------|-----------------------------|-----------|---|----------------------------------|----------------------------------|
| Lagerzapfen zu Kippsystemen | Goupille | | | | | | |
|  |  7 611038 369323 | 07 0358 98 | 2 Stück 2 pièces | 5 |  | 3.45 | 3.71 |



MÜLLEX

| | | | | | | | |
|---|--|-------------------|---------------------|---|---|-------------|-------------|
| Rohrlager | Roulements de tuyaux | | | | | | |
|  |  7 611038 369330 | 07 0359 98 | 2 Stück 2 pièces | 5 |  | 6.20 | 6.67 |



MÜLLEX

| | | | | | | | |
|---|---|-------------------|---------------------|---|--|-------------|-------------|
| Stützwinkel | Angle de soutien | | | | | | |
|  |  7 611038 369347 | 07 0360 98 | 2 Stück 2 pièces | 5 |  | 6.20 | 6.67 |

MÜLLEX

| | | | | | | | |
|---|--|-------------------|--|---|---|-------------|-------------|
| Haltereichen einzeln | Support simple | | | | | | |
|  |  7 611038 369354 | 07 0361 98 | | 5 |  | 7.13 | 7.68 |

MÜLLEX







| | | | | | | | |
|---|--|-------------------|--------------------------------|---|---|--------------|--------------|
| Lagerschiene | Glissière | | | | | | |
|  |  7 611038 172213 | 07 0362 96 | zu SINGLE 35 pour SINGLE 35 | 1 |  | 17.05 | 18.37 |

MÜLLEX

Küche und Waschküche

Cuisine et buanderie

| | EAN-Nr. <i>no EAN</i> | Artikel Nr. <i>no d'article</i> | Beschreibung <i>description</i> | VPE <i>ce</i> | VE <i>ue</i> | UVP pro Stk. <i>PVC</i> CHF excl. | UVP pro Stk. <i>PVC</i> CHF incl. |
|--|--------------------------|------------------------------------|------------------------------------|------------------|-----------------|---|---|
|--|--------------------------|------------------------------------|------------------------------------|------------------|-----------------|---|---|

| Rohr | | Tube | | | | | |
|---|--|-------------------|--------|---|---|--------------|--------------|
|  |  7 611038 172169 | 07 0370 96 | 140 mm | 1 |  | 13.70 | 14.75 |
| |  7 611038 172190 | 07 0371 96 | 225 mm | 1 |  | 14.91 | 16.06 |
| |  7 611038 172206 | 07 0372 96 | 290 mm | 1 |  | 15.94 | 17.16 |

MÜLLEX



Seite / Page
1.8



Seite / Page
4.53



Seite / Page
3.39



Seite / Page
2.23

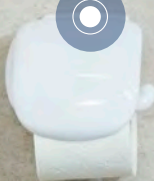

Seite / Page
5.71



Seite / Page
1.68



Seite / Page
1.64



Seite / Page
1.42



Seite / Page
1.71



Seite / Page
2.43

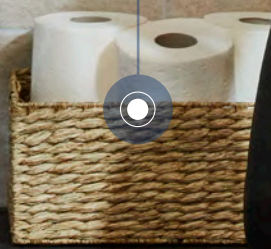



Trinkwasserfilter DrinkPure

Filtre pour l'eau potable DrinkPure

Sauberes Trinkwasser

Eau potable propre

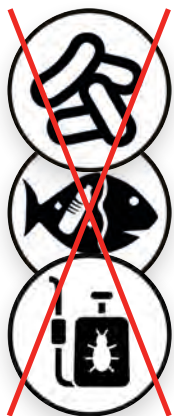

Filtert Schadstoffe wie Bakterien, Mikroplastik, Rost, Pestizide etc. und liefert sauberes Trinkwasser.

Filtre les polluants tels que les bactéries, les microplastiques, la rouille, les pesticides etc. et fournit de l'eau potable propre.

Einfach abnehmbar

Facile à remplacer



Dank dem Kupplungssystem sekunden-schnell abnehmbar.

Détachable en quelques seconds grâce au système d'accouplement.

Abfall und Kosten reduzieren

Réduire les déchets et les coûts

Der DrinkPure ersetzt das Wasser in PET-Flaschen und kann zu einer Kosteneinsparung von 50% führen. Zusätzlich wird der Plastikabfall um bis zu 99% reduziert.

DrinkPure remplace l'eau en bouteilles PET et peut entraîner une réduction des coûts de 50%. De plus, les déchets plastiques sont réduits jusqu'à 99%.

Selbstdesinfizierend

Auto désinfectante



Filterleistung

Capacité de filtration

Der integrierte Filter reinigt bis zu 500 Liter Wasser und kann ganz einfach ausgewechselt werden.

Le filtre intégré nettoie jusqu'à 500 litres d'eau et peut être remplacé très facilement.

Montage

Montage



Hier scannen, um mehr Informationen über die Montage zu erhalten.

Scannez ici pour obtenir plus d'informations sur le montage.

Austausch Kartuschen

Remplacement des cartouches

Der Filter kann mit der Zeit verstopfen, was durch einen verringerten Durchfluss bemerkbar ist. Es wird empfohlen, die Filterkartusche alle zwei Monate zu wechseln.

Avec le temps, le filtre peut se boucher, ce qui se traduit par une diminution du débit. Il est recommandé de remplacer la cartouche filtrante tous les deux mois.

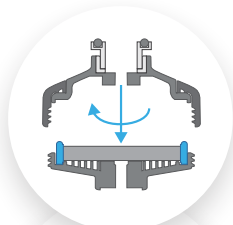

DrinkPure aufschrauben und die obere Hälfte abheben.

Dévisser DrinkPure et soulever la partie supérieure.



Die alte Filterkartusche herausnehmen und im Hausmüll entsorgen.

Retirer l'ancienne cartouche filtrante et la jeter avec les ordures ménagères.

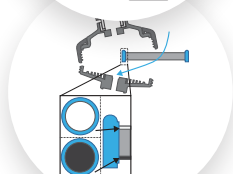

Die neue Filterkartusche mit der weissen Seite nach oben einlegen und den DrinkPure wieder zusammenschrauben.

Insérer la nouvelle cartouche filtrante avec le côté blanc vers le haut et revisser le DrinkPure.

Filtersystem DrinkPure Fresh

Système de filtration DrinkPure Fresh

Das Filtersystem DrinkPure Fresh wird nicht an der Armatur, sondern direkt an der Wasserleitung angeschlossen. Filtert Schadstoffe wie Bakterien, Mikroplastik, Rost, Pestizide etc. und liefert sauberes Trinkwasser. Ein Filter reinigt bis zu 5000 Liter Wasser und sollte alle 6 Monate gewechselt werden.

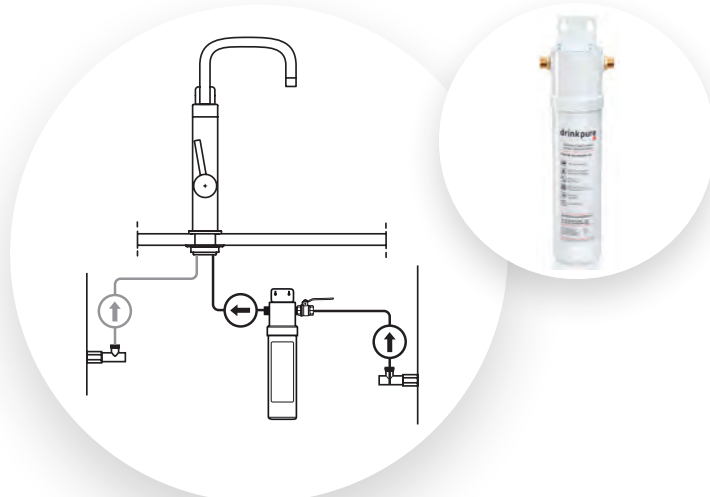

Le système de filtration DrinkPure Fresh n'est pas raccordé au robinet, mais directement à la conduite d'eau. Il filtre les substances nocives telles que les bactéries, les microplastiques, la rouille, les pesticides, etc. et fournit une eau potable propre. Un filtre purifie jusqu'à 5000 litres d'eau et doit être remplacé tous les 6 mois.



Trinkwasserfilter

Filtres pour l'eau potable

| EAN-Nr. no EAN | Artikel Nr. no d'article | Beschreibung description | VPE ce | VE ue | UVP pro Stk. PVC CHF excl. | UVP pro Stk. PVC CHF incl. |
|-------------------|-----------------------------|-----------------------------|-----------|----------|----------------------------------|----------------------------------|
|-------------------|-----------------------------|-----------------------------|-----------|----------|----------------------------------|----------------------------------|



| Trinkwasserfilter | | Filtre pour l'eau potable | | | | |
|---|--|---------------------------|--|---|---|--------------|
|  |  7 629999 516915 | 59 2006 97 | mit Wandhalter, transparent av. support mural, transparent M22 / M24 | 1 |  | 93.10 100.27 |



- Filtriert ohne Einsatz von Chemikalien
- Mind. 50% Kosteneinsparung auf Wasser in Flaschen
- Austauschbare Kartusche reduziert Plastikabfall bis 99 %
- Entfernt Bakterien, Mikroplastik, Mikro-partikel, Rost, Sediment und schlechte Gerüche wie z. B. Chlor.
- Reduziert Pestizide, Hormone und Medikamentenrückstände
- *Filtre sans utilisation des produits chimique*
- *Au moins 50 % d'économies sur l'eau en bouteille*
- *Cartouche interchangeable, réduisant des déchets de plastiques jusqu'à 99 %*
- *Elimine bactéries, microplastiques, microparticules, rouille et sédiments*
- *Réduit les pesticides, les hormones et les résidus de médicaments*
- *Réduction des odeurs*

- Mit der zusätzlich verfügbaren Enthärterkartusche wird auch Kalk reduziert
- In Sekundenschnelle abnehmbar dank dem Kupplungs-System
- Filterleistung bis zu 500 Liter
- Einfache Handhabung
- Selbstdesinfizierend
- Nicht für Niederdruckarmaturen geeignet
- *La cartouche adoucissante disponible en option permet aussi de réduire le tartre*
- *Démontable en quelques secondes*
- *Capacité de filtre jusqu'à 500 litres*
- *Manipulation simple*
- *Auto désinfectante*
- *Ne convient pas aux robinets basse pression*

NEW



| Trinkwasserfilter | | Filtre pour l'eau potable | | | | |
|---|--|---------------------------|---|---|---|--------------|
|  |  7 629999 050389 | 59 2004 97 | mit Wandhalter, schwarz av. support mural, noir M22 / M24 | 1 |  | 93.10 100.27 |





Trinkwasserfilter

Filtres pour l'eau potable

| | EAN-Nr. no EAN | Artikel Nr. no d'article | Beschreibung description | VPE ce | VE ue | UVP pro Stk. PVC CHF excl. | UVP pro Stk. PVC CHF incl. |
|--|-------------------|-----------------------------|-----------------------------|-----------|----------|----------------------------------|----------------------------------|
|--|-------------------|-----------------------------|-----------------------------|-----------|----------|----------------------------------|----------------------------------|



| Trinkwasserfilter m. Kü-Brause | | Filtre pour l'eau a. douchette | | | | | |
|---|--|--------------------------------|---|---|---|---------------|---------------|
|  |  7 629999 996571 | 59 2010 97 | New Look, transp./verchromt New Look, transparent/chromé M22 / M24 ; 1/2" | 1 |  | 130.38 | 140.42 |



| Trinkwasserfilter m. Kü-Brause | | Filtre pour l'eau a. douchette | | | | | |
|--|--|--------------------------------|---|---|---|---------------|---------------|
|  |  7 629999 335226 | 59 2011 97 | New Look Plus, transp. /verchr. New Look Plus, transp./chromé M22 / M24 ; 1/2" | 1 |  | 130.38 | 140.42 |





KWC kompatibel bis Baujahr
2004
Adaptable avec KWC jusqu'à
l'année 2004

| Ersatzkartusche für Filter | | Cartouche de rechange filtre | | | | | |
|---|--|------------------------------|----------------------------------|---|---|--------------|--------------|
|  |  7 629999 051058 | 59 2007 97 | 3 Stück 3 pièces 3 x 500 L | 1 |  | 83.88 | 90.33 |



- Filterleistung bis zu 500 Liter
(ca. 2 Monate)
- Capacité de filtre jusqu'à 500
litres (approx. 2 Mois)

| Enthärterkartusche | | Cartouche pour adoucir | | | | | |
|---|--|------------------------|----------------------------------|---|---|--------------|--------------|
|  |  7 629999 052437 | 59 2009 97 | 3 Stück 3 pièces 3 x 170 L | 1 |  | 46.50 | 50.09 |

Trinkwasserfilter

Filtres pour l'eau potable

| EAN-Nr. no EAN | Artikel Nr. no d'article | Beschreibung description | VPE ce | VE ue | UVP pro Stk. PVC CHF excl. | UVP pro Stk. PVC CHF incl. |
|-------------------|-----------------------------|-----------------------------|-----------|----------|----------------------------------|----------------------------------|
|-------------------|-----------------------------|-----------------------------|-----------|----------|----------------------------------|----------------------------------|

Wandhalter Trinkwasserfilter

Support mural pour filtre



59 2012 96

Edelstahl gebürstet
acier inoxydable mat
60 x 50 x 40 mm ; 1.5 mm, 93°

120



9.60

10.34

- mit Doppelklebband für Wandbefestigung
- avec ruban adhésif à double face pour fixation murale

NEW

Reduktion

Réduction



59 2013 96

Messing verchromt
laiton chromé
IG M24x1 x IG M22x1

1



18.55

19.97

Einige M22 Strahlregler sind vertieft eingebaut. Das kann dazu führen, dass der Standard Adapter von DrinkPure nicht eingebaut werden kann. Diese verlängerte Reduktion (15 mm) ermöglicht die einfache Montage der Schnellkupplung auch bei vertieft eingebauten Strahlreglern.

Certains aérateurs M22 sont montés en profondeur. Cela peut entraîner l'impossibilité de monter l'adaptateur standard de DrinkPure. Cette réduction rallongée (15 mm) permet de monter facilement le raccord rapide même sur les aérateurs installés en profondeur

Trinkwasserfilter



Filtres pour l'eau potable

| EAN-Nr. <i>no EAN</i> | Artikel Nr. <i>no d'article</i> | Beschreibung <i>description</i> | VPE <i>ce</i> | VE <i>ue</i> | UVP pro Stk. <i>PVC</i> CHF excl. | UVP pro Stk. <i>PVC</i> CHF incl. |
|--------------------------|------------------------------------|------------------------------------|------------------|-----------------|---|---|
|--------------------------|------------------------------------|------------------------------------|------------------|-----------------|---|---|

NEW

Reduktion

Réduction

| | | | | | | | |
|---|---|-------------------|--|---|---|--------------|--------------|
|  |  | 59 2014 96 | Messing verchromt <i>laiton chromé</i> AG M24x1 x AG M22x1 | 1 |  | 18.55 | 19.97 |
|---|---|-------------------|--|---|---|--------------|--------------|

Einige M24 Strahlregler sind vertieft eingebaut. Das kann dazu führen, dass der Standard Adapter von DrinkPure nicht eingebaut werden kann. Diese verlängerte Reduktion (15 mm) ermöglicht die einfache Montage der Schnellkupplung auch bei vertieft eingebauten Strahlreglern.

Certains aérateurs M24 sont montés en profondeur. Cela peut entraîner l'impossibilité de monter l'adaptateur standard de DrinkPure. Cette réduction rallongée (15 mm) permet de monter facilement le raccord rapide même sur les aérateurs installés en profondeur.

Trinkwasserfilter



Filtres pour l'eau potable

| EAN-Nr. no EAN | Artikel Nr. no d'article | Beschreibung description | VPE ce | VE ue | UVP pro Stk. PVC CHF excl. | UVP pro Stk. PVC CHF incl. |
|-------------------|-----------------------------|-----------------------------|-----------|----------|----------------------------------|----------------------------------|
|-------------------|-----------------------------|-----------------------------|-----------|----------|----------------------------------|----------------------------------|

NEW

Filtersystem Fresh

Système de filtration Fresh

| | | | | | | |
|--|-------------------|---|---|---|---------------|---------------|
|  7 649991 711019 | 59 2020 97 | für Untertischinstallation sous évier 3/8" x 3/8" | 1 |  | 176.14 | 189.70 |
|--|-------------------|---|---|---|---------------|---------------|



- Entfernt Mikroplastik, Rost, Sedimente und schlechte Gerüche wie z. B. Chlor
- Reduziert Pestizide, Hormone und Medikamentenrückstände
- Untertisch Installation kompatibel mit deiner Küchenarmatur
- Filterleistung bis zu 5'000 Liter je nach Verschmutzungsgrad (ca. 6 Monate)
- *Élimine, microplastiques, microparticules, rouille et des sédiments*
- *Réduit les pesticides, les hormones et les résidus de médicaments*
- *Installation sous évier avec ton robinet*
- *Capacité de filter jusqu'à 5'000 litres (approx. 6 mois)*

Trinkwasserfilter

Filtres pour l'eau potable

| EAN-Nr. no EAN | Artikel Nr. no d'article | Beschreibung description | VPE ce | VE ue | UVP pro Stk. PVC CHF excl. | UVP pro Stk. PVC CHF incl. |
|-------------------|-----------------------------|-----------------------------|-----------|----------|----------------------------------|----------------------------------|
|-------------------|-----------------------------|-----------------------------|-----------|----------|----------------------------------|----------------------------------|

NEW

Ersatzkartus. für Filter Fresh

Cartouche de rech.filtre Fresh



59 2021 97

weiss
blanc

1



93.10

100.27



- Filterleistung bis 5'000 Liter (ca.6 Monate)
- Nach Installation Wasser für 30 Sekunden durchlaufen lassen um Aktivkohlestaub herauszuspülen
- Capacité de filtre jusqu'à 5'000 litres (approx. 6 mois)
- Après l'installation laisser l'eau s'écouler pendant 30 secondes, pour rincer la poussière de charbon actif

Trinkwasserfilter

Filtres pour l'eau potable

| EAN-Nr. no EAN | Artikel Nr. no d'article | Beschreibung description | VPE ce | VE ue | UVP pro Stk. PVC CHF excl. | UVP pro Stk. PVC CHF incl. |
|-------------------|-----------------------------|-----------------------------|-----------|----------|----------------------------------|----------------------------------|
|-------------------|-----------------------------|-----------------------------|-----------|----------|----------------------------------|----------------------------------|

NEW

Filterkopf Fresh

Tête de filtre Fresh



59 2022 97

weiss
blanc
3/8" x 3/8"

1



83.78

90.23



2 x 3/8" Anschluss mit
Innengewinde
max. Betriebsdruck 5.0 Bar
min. Betriebsdruck 0.7 Bar
max. Betriebstemperatur 65°C
min. Betriebstemperatur 5°C
2 x 3/8" raccord avec un filetage
mâle
Pression de fonctionnement max.
5.0 bar
Pression de fonctionnement min.
0.7 bar
Température max. de
fonctionnement 65°C
Température min. de
fonctionnement 5°C